

# DESIGN ART™

by ORION



**PORTER  
PRESTON**

Quality Wholesale Window Coverings

Contract • Hospitality • Healthcare • Residential

ph 866-753-1113 email [customerservice@porterpreston.com](mailto:customerservice@porterpreston.com) [www.porterpreston.com](http://www.porterpreston.com)

CELEBRATE YOUR CREATIVITY...  
2015 Drapery Hardware Retail Price List



DESIGN ART™  
by ORION

# PRICE LIST ITEM GUIDE

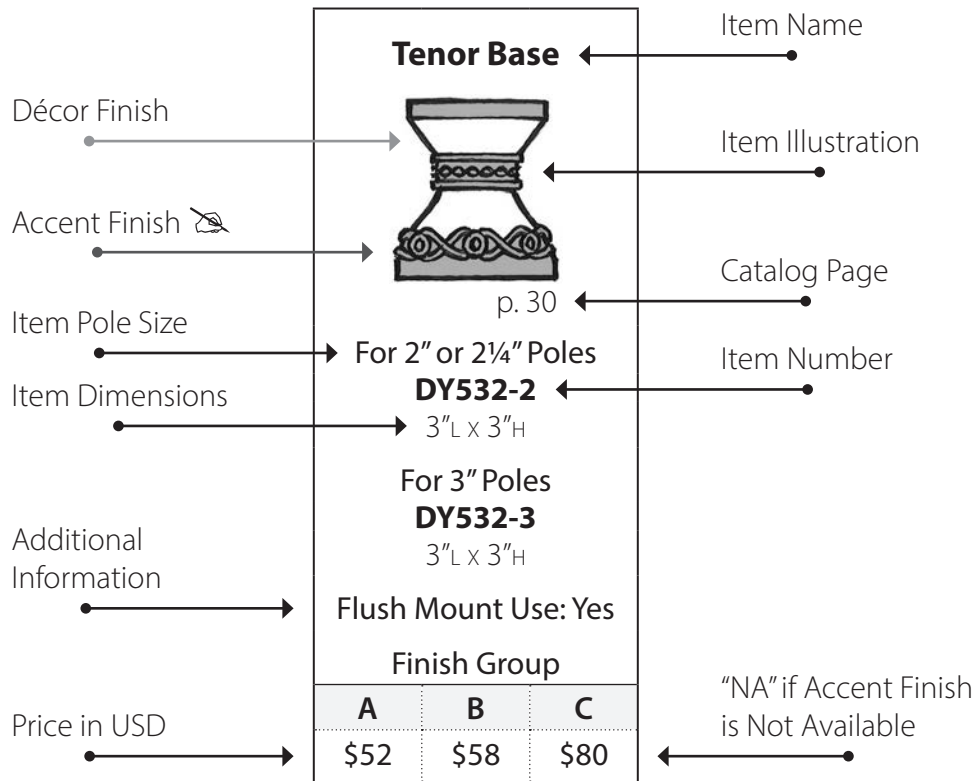

## MORE GUIDES

Accessories Guide: Iron .....	73
Accessories Guide: Wood .....	72
Finish Guide .....	4-5
Order Forms .....	94-97
Production Times Guide .....	93
Return Policy Guide .....	92
Summary of Charges .....	93
SwissCrystal Guide .....	22
SwissCrystal Base Guide .....	25
Terms of Sale .....	90-93
Traversing Guides: Glides .....	50
Traversing Guides: Tracks .....	51
Traversing Guides: Installation .....	52-53

# CONTENTS

<b>Finishes</b>	4-5
58 Décor Finishes: Groups A & B	Finish Notes
Dual Finish System with 11 Accent Finishes ☞ (Group C)	
<b>Quick Ship</b>	6-9
Items Available with 7 Working Day Shipping	
<b>Finials</b>	10-15
For 1 $\frac{3}{8}$ ", 2", 2 $\frac{1}{4}$ " and 3" Diameter Poles	
<b>Rod-Enders</b>	16-19
For 1 $\frac{3}{8}$ ", 2", 2 $\frac{1}{4}$ " and 3" Diameter Poles	
<b>Crystal Collection</b>	20-37
SwissCrystal Guide .....	22
SwissCrystal-On-Wood For 1 $\frac{3}{8}$ ", 2", 2 $\frac{1}{4}$ " and 3" Diameter Poles .....	23-24
SwissCrystal Base Guide .....	25
SwissCrystal Bases .....	26-29
SwissCrystal Holdbacks and Medallions .....	30-31
SwissCrystal Stair Newels .....	31
SwissCrystal-On-Iron For 1 $\frac{1}{4}$ " Diameter Rods .....	32-35
Bohemia-On-Wood For 1 $\frac{3}{8}$ ", 2" and 2 $\frac{1}{4}$ " Diameter Poles .....	36-37
<b>Inlay Collection</b>	38-45
10 Inlay & Decal Designs for 2 $\frac{1}{4}$ " and 3" Diameter Poles	
<b>Wood Poles, Traversing &amp; Motorization</b>	46-69
Pole Styles: Smooth, Fluted, Rope and Inlay .....	48-49
Traversing Guides .....	50-53
Manual Traversing Poles .....	54-57
Manual Traversing Accessories .....	58-61
Motorized Traversing Poles .....	62-65
Motorized Traversing Accessories .....	66-69
<b>Accessories</b>	70-86
Accessories Guide .....	72-73
Wood Brackets .....	74-77
Sockets & End Caps .....	78
Batons .....	79
Wood Rings .....	80-81
Iron Rings .....	82
Iron Brackets .....	83-85
Holdbacks .....	86
<b>Elegant Adornments</b>	87
Centerpieces for Poles, Crystal Stair Newels, & Medallions	
<b>Selling Tools</b>	88-89
Wall Displays, TableTopper Display, ShowOff Samples, Catalog Set, Promotional Binder & Finish Swatch	
<b>Terms of Sale</b>	90-93
<b>Order Forms</b>	94-97
<b>Measurements</b>	98

# FINISHES

Throughout our catalog you will see two items side-by-side: One is shown in a single Décor Finish (Groups A or B), and beside it is another with our Dual Finish System with 11 Accent Finishes (Groups A or B plus Group C). **It's your choice:** Elegantly simple Décor Finishes - Groups A or B, or exquisitely detailed with Accent Finishes - Group C.

Below is our finish guide showing the Décor Finish group, finish name and number, the sheen the finish comes with, and the color track that will be used with manual or motorized traversing systems (unless otherwise specified).

Décor Finishes - A	Code / Finish	Sheen	Track Finish
Antique Bronze	DP902A	Matte	Ant. Bronze
Antique Copper	DP910A	Matte	Black
Antique Gold	DP906A	Matte	Ant. Bronze
Black-Glossy	DP937A	Gloss	Black
Black-Satin	DP914A	Matte	Black
Bronze Pewter	DP909A	Matte	Ant. Bronze
Bronze Vecchio	DP915A	Matte	Ant. Bronze
Brown	DP919A	Matte	Black
Burnt Gold	DP925A	Matte	Ant. Bronze
Cast Iron	DP912A	Matte	Ant. Bronze
Copper Glimmer	DP918A	Matte	Ant. Bronze
Copper Penny	DP961A	Matte	Ant. Bronze
English Bronze	DP922A	Matte	Ant. Bronze
Frosty Morn	DP924A	Matte	Silver
Hammered Silver	DP929A	Matte	Silver
Naturelle	DP903A	Matte	Black
Old Black	DP901A	Matte	Black
Old Rust	DP955A	Matte	Ant. Bronze
Pure White-Glossy	DP936A	Gloss	White
Pure White-Satin	DP933A	Matte	White
Royal Red	DP942A	Matte	Gold
Rusty	DP904A	Matte	Black
Silver Shimmer	DP947A	Matte	Silver
Soft Pewter	DP913A	Matte	Black
Steel	DP949A	Matte	Ant. Bronze
Superior Bronze	DP950A	Matte	Ant. Bronze
Urbane Bronze	DP951A	Matte	Ant. Bronze
White Dove	DP954A	Matte	White

Décor Finishes - B	Code / Finish	Sheen	Track Finish
Aged Brass	DP956B	Matte	Ant. Bronze
Aged Chestnut	DP905B	Semi-Gloss	Ant. Bronze
Black Embers	DP908B	Semi-Gloss	Black
Champagne	DP948B	Matte	Gold
Chateau	DP916B	Matte	Ant. Bronze
Cherrywood	DP917B	Semi-Gloss	Black
Clouds	DP911B	Matte	White
Creamy	DP920B	Matte	White
Ebony	DP921B	Semi-Gloss	Black
French Nobility	DP923B	Matte	White
Gold Leaf-Antiqued	DP941B	Matte	Gold
Gold Leaf-Burnished	DP926B	Matte	Gold
Gold Leaf-Polished	DP927B	Matte	Gold
Gold Leaf-Traditional	DP928B	Matte	Gold
Hickory	DP930B	Semi-Gloss	Gold
Italian Gold	DP931B	Semi-Gloss	Gold
Italian Walnut	DP932B	Matte	Gold
Liquid Gold Leaf	DP963B	Matte	Gold
Mahogany	DP943B	Semi-Gloss	Black
Monarch	DP960B	Matte	Silver
Paris Rain	DP962B	Matte	Silver
Precious Metals	DP939B	Matte	Gold
Queensland Walnut	DP940B	Semi-Gloss	Black
Rich Gold	DP907B	Matte	Gold
Sage	DP946B	Matte	Silver
Silver Leaf-Burnished	DP944B	Matte	Silver
Silver Leaf-Polished	DP945B	Matte	Silver
Vintage Gold	DP952B	Semi-Gloss	Gold
Weathered Iron	DP953B	Matte	Ant. Bronze
Zinc	DP957B	Matte	Ant. Bronze

Accent Finishes - C	Code / Finish	Sheen
Antique Bronze	DP902C	Matte
Antique Gold	DP906C	Matte
Black-Matte	DP914C	Matte
Gold Leaf-Antiqued	DP941C	Matte
Gold Leaf-Burnished	DP926C	Matte
Gold Leaf-Polished	DP927C	Matte
Gold Leaf-Traditional	DP928C	Matte
Liquid Gold Leaf	DP963C	Matte
Silver Leaf-Burnished	DP944C	Matte
Silver Leaf-Polished	DP945C	Matte
Soft Pewter	DP913C	Matte

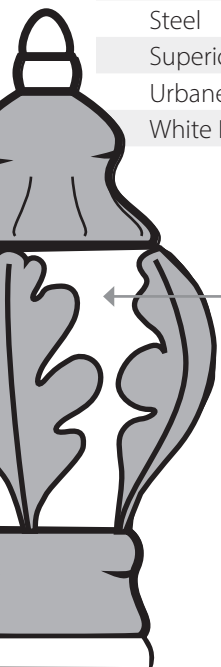

Décor Finish

Accent Finish

Throughout the price list you will see each product illustrated to show the placement of **Décor Finishes** and **Dual Finish System Accent Finishes**.

# FINISH NOTES

## PAINTING PROCESS

All Design Art items are hand painted after we receive your order. Items are painted together to ensure a consistent finish. Due to the nature of wood grain in the products and hand painting, some variations will occur. Finials, poles, brackets and rings each absorb paints and stains differently, making each order beautifully one-of-a-kind.

## FINISHES

The finishes presented in the catalog are photographic and lithographic reproductions, and as such may not accurately reflect the true depth and tone of our finishes. Please refer to our actual color swatch samples before ordering. Our color swatches show both smooth and detailed surfaces, indicating how the finish will look on various products.

## TOPCOAT SHEENS

Design Art colors primarily use a Matte or Semi-Gloss topcoat (see color swatches for actual sheen). We can change the topcoat finish to your choice of Glossy, Semi-Gloss, or Matte at no additional charge, to achieve your preferred sheen level.

## TOUCH-UP PAINT

Touch-up paint is available upon request for an additional charge.

## ADDITIONAL PAINTING FEES

We can repaint finished or unfinished hardware from other manufactures upon request. Please contact customer service for a quote.

## CUSTOM PALETTE

We have several options for further customization of your product. Please contact customer service for a quote.

### *MATCH MY COLOR*

Choose a color from Benjamin Moore or Sherwin Williams, or send us a fabric or other color swatch to match. Let us know whether you prefer a Gloss, Semi-Gloss or Matte sheen. We'll send you a strike-off for your approval.

### *MATCH MY COLOR AND ADD ACCENTS*

We can match your custom color and add accents from any of our 11 Accent Finishes  like those shown in the catalog on pages 77-78.

### *MATCH MY COLOR AND ADD HIGHLIGHTS*

Use any of our 58 Décor Finishes, or your own custom finish, and add Gold, Silver or Bronze Highlights--

- To the carved areas of the piece
- Over the entire piece

### Color Strike-Off



#### **DASTRIKE**

One-time strike-off charge.  
All custom finishes need prior approval before production.

**Price:** \$40 Net

### Touch Up Paint

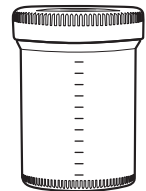

#### **DS700 - 1 OUNCE**

Touch up paint is available for any Décor Finish except Gold or Silver Leaf finishes, and any Swiss-Crystal-On-Iron Finish except Chrome or Brushed Nickel.

**Price:** \$18 Net



# QUICK SHIP

Shipping in 7 business days

For 2" Diameter Smooth or Fluted Poles

## DETAILS

Our Quick Ship program brings you some of our most popular styles and finishes with expedited shipping. Instead of shipping in 15 business days, these items will ship in 7 business days.

Please note our Quick Ship program is available in 6 Décor Finishes only.

- 2 Pole Options:
  - 2" Diameter Smooth
  - 2" Diameter Fluted
- 16 Finial Options:
  - 6 Finials
  - 2 Rod-Enders
  - 4 SwissCrystals (With Standard Base Only)
  - 4 Bohemia Crystals
- 5 Bracket Options:
  - American Bracket with 4" Projection
  - American Bracket with 7" Projection
  - Iron Bracket with 4" Projection
  - Iron Bracket with 6" Projection
  - Iron Ceiling Bracket
- 3 Ring Options:
  - Smooth Wood Ring
  - Fluted Wood Ring
  - Smooth Iron Ring
- 6 Accessories:
  - Smooth Wood Post Holdback
  - Fluted Wood Post Holdback
  - Iron Post Holdback
  - Standard Socket Bracket
  - End Cap
  - Baton
- 6 Finishes:
  - Antique Bronze (A) DP902A
  - Antique Gold (A) DP906A
  - Black-Satin (A) DP914A
  - Cast Iron (A) DP912A
  - Naturelle (A) DP903A
  - Soft Pewter (A) DP913A

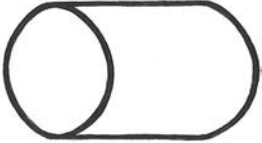
<b>Smooth Pole</b>				Please see price list pages 47-49 for more information about ordering wood poles.					
		p. 52							
Finish Group	Unit	2 Feet	4 Feet	6 Feet	8 Feet	10 Feet	12 Feet	14 Feet	16 Feet
<b>DSM-200 - Smooth Pole: 2" Diameter</b>									
A	EACH	\$56	\$112	\$168	\$224	\$280	\$336	\$392	\$448

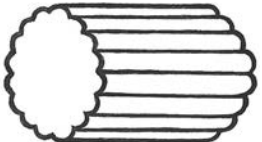
<b>Fluted Pole</b>				Please see price list pages 47-49 for more information about ordering wood poles.					
		p. 52							
Finish Group	Unit	2 Feet	4 Feet	6 Feet	8 Feet	10 Feet	12 Feet	14 Feet	16 Feet
<b>DFL-200 - Fluted Pole: 2" Diameter</b>									
A	EACH	\$56	\$112	\$168	\$224	\$280	\$336	\$392	\$448



Items available for Quick Ship are labeled throughout the price list.



<p><b>Elegance Finial</b></p>  <p>p. 9</p> <p><b>DF033-2</b> 6¼" L x 3" H</p> <p>Price Each: \$62</p>	<p><b>Fluted Ball Finial</b></p>  <p>p. 10</p> <p><b>DF069-2</b> 6½" L x 4¼" H</p> <p>Price Each: \$76</p>	<p><b>Fruit Finial</b></p>  <p>p. 10</p> <p><b>DF095-2</b> 6½" L x 3½" H</p> <p>Price Each: \$68</p>	<p><b>Noble Finial</b></p>  <p>p. 11</p> <p><b>DF514-2</b> 6⅞" L x 4" H</p> <p>Price Each: \$76</p>
<p><b>Oak &amp; Acorn Finial</b></p>  <p>p. 11</p> <p><b>DF071-2</b> 6¾" L x 4" H</p> <p>Price Each: \$66</p>	<p><b>Prestige Finial</b></p>  <p>p. 13</p> <p><b>DF505-2</b> 6¾" L x 4¼" H</p> <p>Price Each: \$84</p>	<p><b>Ballet Rod-Ender</b></p>   <p>p. 18</p> <p><b>DE049-2</b> 2⅝" L x 3½" H</p> <p>Flush Mount Use: Yes</p> <p>Price Each: \$50</p>	<p><b>Michele Rod-Ender Small</b></p>   <p>p. 19</p> <p><b>DE598-2</b> 1½" L x 3" H</p> <p>Flush Mount Use: Yes</p> <p>Price Each: \$36</p>
<p><b>Empress Crystal 4" Diameter</b></p>  <p>p. 27, 32</p> <p><b>DC804-2</b> 3⅞" L x 4" H</p> <p>Price Each: \$148</p>	<p><b>Fascination Crystal 4" Diameter</b></p>  <p>p. 23, 24, 26-28, 32</p> <p><b>DC805-2</b> 3⅞" L x 4" H</p> <p>Price Each: \$148</p>	<p><b>Petite Elise Crystal 3" Diameter</b></p>  <p>p. 23, 25, 28, 29, 31</p> <p><b>DC809-2</b> 3⅞" L x 3½" H</p> <p>Price Each: \$136</p>	<p><b>Twinkle Crystal 1¼" x 3"</b></p>  <p>p. 23, 27</p> <p><b>DC815-2</b> 1⅞" L x 3¼" H</p> <p>Price Each: \$148</p>
<p><b>Crescent Crystal</b></p>  <p>p. 35</p> <p><b>DC772-2</b> 2¾" L x 2⅜" H</p> <p>Price Each: \$80</p>	<p><b>Orb Crystal</b></p>  <p>p. 36</p> <p><b>DC781-2</b> 2⅛" L x 2⅜" H</p> <p>Price Each: \$64</p>	<p><b>Prism Crystal</b></p>  <p>p. 36</p> <p><b>DC779-2</b> 1½" L x 3⅛" H</p> <p>Price Each: \$76</p>	<p><b>Shimmer Crystal</b></p>  <p>p. 36</p> <p><b>DC773-2</b> 2¾" L x 2⅜" H</p> <p>Price Each: \$80</p>



# QUICK SHIP

Brackets, Rings, and Accessories for 2" Diameter Poles.

**American Bracket**



p. 59

**DB5045-4P-200**  
6<sup>3</sup>/<sub>8</sub>" L X 6<sup>3</sup>/<sub>4</sub>" H  
7<sup>7</sup>/<sub>8</sub>" THICK; 4" PROJECTION

Price Each: \$38

**American Bracket**

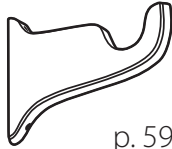

p. 59

**DB5045-7P-200**  
9<sup>1</sup>/<sub>8</sub>" L X 6<sup>3</sup>/<sub>4</sub>" H  
1" THICK; 7" PROJECTION

Price Each: \$44

**Iron End Bracket with Lip**

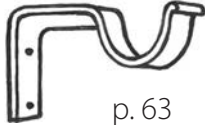

p. 63

**DB1028-RND-4P-200**  
4" H X 1" W  
4" PROJECTION

Price Each: \$28

**Iron End Bracket with Lip**

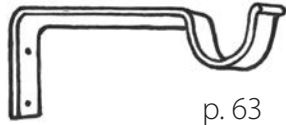

p. 63

**DB1028-RND-6P-200**  
4" H X 1" W  
6" PROJECTION

Price Each: \$38

**Iron Ceiling Bracket**



p. 63

**DB1035-RND-200**  
4" H X 1" W  
3" PROJECTION : 4" DROP

Price Each: \$28

**Smooth Ring**



p. 62

**DG5047-225**  
1/2" THICK  
2<sup>5</sup>/<sub>8</sub>" INNER DIAMETER  
3<sup>5</sup>/<sub>8</sub>" OUTER DIAMETER

Price Each: \$12

**Fluted Ring**



p. 62

**DG5049-225**  
3/4" THICK  
2<sup>3</sup>/<sub>4</sub>" INNER DIAMETER  
4<sup>1</sup>/<sub>4</sub>" OUTER DIAMETER

Price Each: \$12

**Round Iron Ring**



p. 63

**DG350-200**  
1/4" THICK  
2<sup>1</sup>/<sub>2</sub>" INNER DIAMETER  
3" OUTER DIAMETER

Price Each: \$8

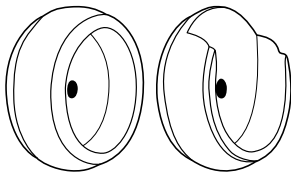

p. 61

**Standard Socket Bracket**

**DB5051-200**  
1<sup>1</sup>/<sub>8</sub>" L X 2<sup>5</sup>/<sub>8</sub>" H  
SOLD AS PAIR

Price Each: \$52

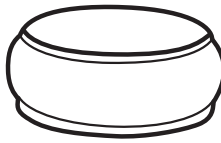

p. 61

**End Cap**

**DE5052-200**  
1<sup>1</sup>/<sub>8</sub>" L X 2<sup>3</sup>/<sub>4</sub>" H

Price Each: \$52

**Smooth Wood Post Holdback**



p. 31, 64

2" DIAMETER POLE

2<sup>1</sup>/<sub>2</sub>" Projection  
**DM1090-SM-250**

4" Projection  
**DM1090-SM-400**

6" Projection  
**DM1090-SM-600**

Price Each: \$24

**Fluted Wood Post Holdback**



p. 31, 64

2" DIAMETER POLE

2<sup>1</sup>/<sub>2</sub>" Projection  
**DM1090-FL-250**

4" Projection  
**DM1090-FL-400**

6" Projection  
**DM1090-FL-600**

Price Each: \$24

**Iron Post Holdback**

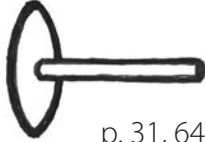

p. 31, 64

BACKPLATE: 3<sup>1</sup>/<sub>8</sub>" DIAMETER

3" Projection  
**DM1088-300**

4" Projection  
**DM1088-400**

6<sup>1</sup>/<sub>2</sub>" Projection  
**DM1088-650**

Price Each: \$20

**Wood Round Baton with Wood Handle**



p. 61

Clip Only  
**DM5053**  
1/2" DIAMETER  
38" LONG

Price Each: \$42





# QUICK SHIP ORDER FORM



CUSTOMER INFORMATION							
Company Name:					Page ____ of ____		
Ordered By (Name):					Order Date:		
Side Mark:					Account#:		
Phone:					PO#:		
Ship to:							
Street:							
City:			State:		Zip:		Delivery Location: Business: <input type="checkbox"/> Residential: <input type="checkbox"/>
Ship Via:	FedEx Ground: <input type="checkbox"/>	3 Day: <input type="checkbox"/>	2 Day: <input type="checkbox"/>	Overnight: <input type="checkbox"/>	Truck: <input type="checkbox"/>	Will Call: <input type="checkbox"/>	Other:

Our Quick Ship program brings you some of our most popular styles and finishes with expedited shipping. Instead of shipping in 15 business days, Quick Ship items will ship in 7 business days.  
*Please note our Quick Ship program is available in 6 Décor Finishes only.*

POLES					
Qty.	Product #	Length (In.) (Not Including Finials)	Wood Pole Splice #DM5054 Y/N	Décor Finish Name/Number	Room ID

We splice any wood pole or iron rod over 106" to save on shipping charges using FedEx. *(New Fed Ex surcharge above 96" in length per box will be added in addition to the shipping and handling charges.)*

Poles not specified as one piece will be spliced in the center, unless a splice location is otherwise noted.  
 Special Instructions:

FINIALS • ROD-ENDERS SWISSCRYSTALS • BOHEMIA CRYSTALS				BRACKETS				
Qty.	Product #	Décor Finish Name/Number	Room ID	Qty.	Product #	Proj. (In.)	Décor Finish Name/Number	Room ID

RINGS				BATONS			
Qty.	Product #	Décor Finish Name/Number	Room ID	Qty.	Product #	Décor Finish Name/Number	Room ID

HOLDBACKS						
Qty.	Product # Finial, Rod-Enders, SwissCrystal, or Bohemia Crystal	Type Iron U-Bend, Iron Post, or Wood Post	Projection (Inches)	Décor Finish Name/Number	Room ID	

Quick Ship is available in 6 Décor Finishes:  
 • Antique Bronze (A) DP902A • Antique Gold (A) DP906A • Black-Satin (A) DP914A  
 • Cast Iron (A) DP912A • Naturelle (A) DP903A • Soft Pewter (A) DP913A

# FINIALS



# FINIALS

## DETAILS

- All Design Art finials are designed to fit more than one size pole.  
Finials for 1 $\frac{3}{8}$ " poles will fit 2" or 2 $\frac{1}{4}$ " poles with an adaptor.  
Finials for 2" or 2 $\frac{1}{4}$ " poles will fit 3" poles with an adaptor.
- The adaptor will be added automatically, **at no additional charge** when needed.  
The small adaptor measures  $\frac{5}{8}$ " L x 2 $\frac{5}{8}$ " H.  
The large adaptor measures  $\frac{5}{8}$ " L x 3 $\frac{3}{8}$ " H.
- When the Dual Finish System is used, the adaptor will be in the Accent Finish.
- Due to the nature of hand-crafted items, Finial dimensions may vary slightly from piece to piece. Finial pairs will be matched as closely as possible when ordered.

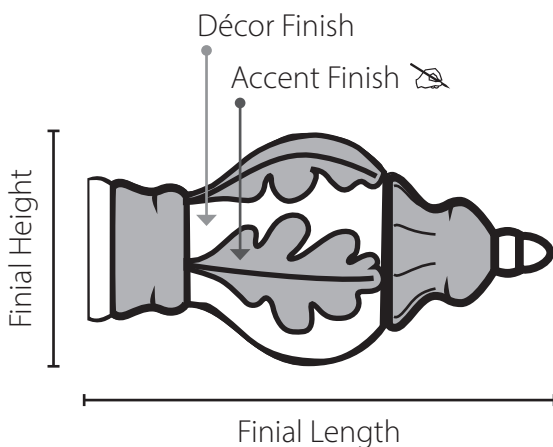
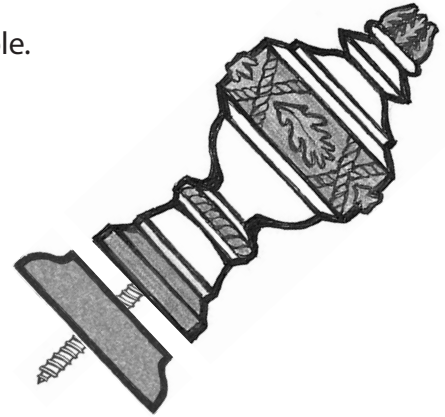

Select one of our **58 Décor Finishes**  
or our **Dual Finish System with**  
**11 Accent Finishes** 

When ordering complete drapery hardware sets and accessories don't forget to include:

- Poles (1 $\frac{3}{8}$ ", 2" 2 $\frac{1}{4}$ " or 3") (pages 48-49)
- Brackets (pages 74-77 and 83-85)
- Rings (pages 80-82)
- Batons\* (page 79)
- Holdbacks\* (page 86)

\*optional







## SHIPPING & INSTALLATION NOTES

Finials come complete with screws for installing into wood. Orion wood poles are pre-drilled. Just screw the finial into the wood pole, and you are set for installation.



# FINIALS

Finials for 1 3/8" diameter poles; with Adaptor (included in Finial price) for 2" or 2 1/4" diameter poles.

<p><b>Bouquet Finial</b></p>  <p>p. 7</p> <p>For 1 3/8" Poles <b>DF402-1</b> 3 3/4" L x 3 1/4" H</p> <p>For 2" or 2 1/4" Poles <b>DF402-2</b> 4 3/8" L x 3 1/4" H</p> <p>Finish Group</p> <table border="1"> <thead> <tr> <th>A</th> <th>B</th> <th>C</th> </tr> </thead> <tbody> <tr> <td>\$54</td> <td>\$74</td> <td>\$94</td> </tr> </tbody> </table>			A	B	C	\$54	\$74	\$94	<p><b>Festival Finial</b></p>  <p>p. 7</p> <p>For 1 3/8" Poles <b>DF107-1</b> 3 5/8" L x 2 3/8" H</p> <p>For 2" or 2 1/4" Poles <b>DF107-2</b> 4 1/4" L x 2 3/8" H</p> <p>Finish Group</p> <table border="1"> <thead> <tr> <th>A</th> <th>B</th> <th>C</th> </tr> </thead> <tbody> <tr> <td>\$44</td> <td>\$66</td> <td>\$86</td> </tr> </tbody> </table>			A	B	C	\$44	\$66	\$86	<p><b>Holiday Finial</b></p>  <p>p. 7</p> <p>For 1 3/8" Poles <b>DF106-1</b> 4 3/8" L x 2 1/2" H</p> <p>For 2" or 2 1/4" Poles <b>DF106-2</b> 5" L x 2 1/2" H</p> <p>Finish Group</p> <table border="1"> <thead> <tr> <th>A</th> <th>B</th> <th>C</th> </tr> </thead> <tbody> <tr> <td>\$52</td> <td>\$70</td> <td>\$90</td> </tr> </tbody> </table>			A	B	C	\$52	\$70	\$90	<p><b>Hospitality Finial</b></p>  <p>p. 7</p> <p>For 1 3/8" Poles <b>DF101-1</b> 4" L x 2 3/4" H</p> <p>For 2" or 2 1/4" Poles <b>DF101-2</b> 4 5/8" L x 2 3/4" H</p> <p>Finish Group</p> <table border="1"> <thead> <tr> <th>A</th> <th>B</th> <th>C</th> </tr> </thead> <tbody> <tr> <td>\$48</td> <td>\$68</td> <td>\$88</td> </tr> </tbody> </table>			A	B	C	\$48	\$68	\$88
A	B	C																																	
\$54	\$74	\$94																																	
A	B	C																																	
\$44	\$66	\$86																																	
A	B	C																																	
\$52	\$70	\$90																																	
A	B	C																																	
\$48	\$68	\$88																																	
<p><b>Keepsake Finial</b></p>  <p>p. 8</p> <p>For 1 3/8" Poles <b>DF096-1</b> 4" L x 2 7/8" H</p> <p>For 2" or 2 1/4" Poles <b>DF096-2</b> 4 5/8" L x 2 7/8" H</p> <p>Finish Group</p> <table border="1"> <thead> <tr> <th>A</th> <th>B</th> <th>C</th> </tr> </thead> <tbody> <tr> <td>\$46</td> <td>\$64</td> <td>\$84</td> </tr> </tbody> </table>			A	B	C	\$46	\$64	\$84	<p><b>Lattice Finial</b></p>  <p>p. 8</p> <p>For 1 3/8" Poles <b>DF100-1</b> 4" L x 3 1/8" H</p> <p>For 2" or 2 1/4" Poles <b>DF100-2</b> 4 5/8" L x 3 1/8" H</p> <p>Finish Group</p> <table border="1"> <thead> <tr> <th>A</th> <th>B</th> <th>C</th> </tr> </thead> <tbody> <tr> <td>\$44</td> <td>\$66</td> <td>\$86</td> </tr> </tbody> </table>			A	B	C	\$44	\$66	\$86	<p><b>Majesty Finial</b></p>  <p>p. 8</p> <p>For 1 3/8" Poles <b>DF102-1</b> 3 7/8" L x 3" H</p> <p>For 2" or 2 1/4" Poles <b>DF102-2</b> 4 1/2" L x 3" H</p> <p>Finish Group</p> <table border="1"> <thead> <tr> <th>A</th> <th>B</th> <th>C</th> </tr> </thead> <tbody> <tr> <td>\$42</td> <td>\$60</td> <td>\$78</td> </tr> </tbody> </table>			A	B	C	\$42	\$60	\$78	<p><b>Twirl Finial</b></p>  <p>p. 8</p> <p>For 1 3/8" Poles <b>DF089-1</b> 4 1/4" L x 3 1/8" H</p> <p>For 2" or 2 1/4" Poles <b>DF089-2</b> 4 7/8" L x 3 1/8" H</p> <p>Finish Group</p> <table border="1"> <thead> <tr> <th>A</th> <th>B</th> <th>C</th> </tr> </thead> <tbody> <tr> <td>\$44</td> <td>\$66</td> <td>\$86</td> </tr> </tbody> </table>			A	B	C	\$44	\$66	\$86
A	B	C																																	
\$46	\$64	\$84																																	
A	B	C																																	
\$44	\$66	\$86																																	
A	B	C																																	
\$42	\$60	\$78																																	
A	B	C																																	
\$44	\$66	\$86																																	



Finials for 2" or 2¼" diameter poles; with Adaptor (included in Finial price) for 3" diameter poles.

## Autumn Finial



p. 9

For 2" or 2¼" Poles

**DF500-2**

7⅛" L x 3¾" H

For 3" Poles

**DF500-3**

7¾" L x 3¾" H

Finish Group

A	B	C
\$66	\$88	\$108

## Cameo Finial



p. 9

For 2" or 2¼" Poles

**DF504-2**

6¾" L x 3½" H

For 3" Poles

**DF504-3**

7¾" L x 3½" H

Finish Group

A	B	C
\$70	\$90	\$112

## Elegance Finial



p. 9

For 2" or 2¼" Poles

**DF033-2**

6¼" L x 3" H

For 3" Poles

**DF033-3**

6⅞" L x 3⅞" H

Finish Group

A	B	C
\$62	\$82	\$102

## Eucalyptus Finial



p. 9

For 2" or 2¼" Poles

**DF569-2**

7¼" L x 3¼" H

For 3" Poles

**DF569-3**

7⅞" L x 3¼" H

Finish Group

A	B	C
\$74	\$96	\$116

## Finery Finial



p. 10

For 2" or 2¼" Poles

**DF404-2**

5¼" L x 3⅝" H

For 3" Poles

**DF404-3**

5⅞" L x 3⅝" H

Finish Group

A	B	C
\$64	\$84	\$106

## Fleur de Lys Finial



p. 10

For 2" or 2¼" Poles

**DF506-2**

6¾" L x 3¼" H

For 3" Poles

**DF506-3**

7⅞" L x 3⅞" H

Finish Group

A	B	C
\$80	\$102	\$122



Available for Quick Ship. See pages 6-9.



# 2"-3" FINIALS

Finials for 2" or 2¼" diameter poles; with Adaptor (included in Finial price) for 3" diameter poles.

**Fluted Ball Finial**



**QUICK SHIP** p. 10

For 2" or 2¼" Poles  
**DF069-2**  
6½" L x 4¼" H

For 3" Poles  
**DF069-3**  
7⅞" L x 4¼" H

Finish Group

A	B	C
\$76	\$98	\$118

**Fruit Finial**



**QUICK SHIP** p. 10

For 2" or 2¼" Poles  
**DF095-2**  
6½" L x 3½" H

For 3" Poles  
**DF095-3**  
7⅞" L x 3½" H

Finish Group

A	B	C
\$68	\$88	\$108

**Garland Finial**



p. 11

For 2" or 2¼" Poles  
**DF509-2**  
6¾" L x 3¾" H

For 3" Poles  
**DF509-3**  
7⅜" L x 3¾" H

Finish Group

A	B	C
\$68	\$94	\$112

**Harvest Finial**



p. 11

For 2" or 2¼" Poles  
**DF513-2**  
6⅝" L x 3¾" H

For 3" Poles  
**DF513-3**  
7¼" L x 3¾" H

Finish Group

A	B	C
\$72	\$94	\$114

**Noble Finial**



**QUICK SHIP** p. 11

For 2" or 2¼" Poles  
**DF514-2**  
6⅞" L x 4" H

For 3" Poles  
**DF514-3**  
7½" L x 4" H

Finish Group

A	B	C
\$76	\$98	\$118

**Oak & Acorn Finial**



**QUICK SHIP** p. 11

For 2" or 2¼" Poles  
**DF071-2**  
6¾" L x 4" H

For 3" Poles  
**DF071-3**  
7⅜" L x 4" H

Finish Group

A	B	C
\$66	\$88	\$108

**Opera Finial**



p. 12

For 2" or 2¼" Poles  
**DF516-2**  
6½" L x 3¼" H

For 3" Poles  
**DF516-3**  
7⅞" L x 3¼" H

Finish Group

A	B	C
\$76	\$98	\$118

**Ornament Finial**



p. 12

For 2" or 2¼" Poles  
**DF520-2**  
6¼" L x 3¾" H

For 3" Poles  
**DF520-3**  
6⅞" L x 3¾" H







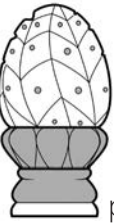

Finish Group

A	B	C
\$72	\$94	\$114



Available for Quick Ship. See pages 6-9.

Finials for 2" or 2¼" diameter poles; with Adaptor (included in Finial price) for 3" diameter poles.

<p><b>Paisley Finial</b></p>  <p>p. 12</p> <p>For 2" or 2¼" Poles <b>DF522-2</b> 6¾" L x 3¾" H</p> <p>For 3" Poles <b>DF522-3</b> 7⅜" L x 3¾" H</p> <p>Finish Group</p> <table border="1"> <thead> <tr> <th>A</th> <th>B</th> <th>C</th> </tr> </thead> <tbody> <tr> <td>\$74</td> <td>\$96</td> <td>\$116</td> </tr> </tbody> </table>	A	B	C	\$74	\$96	\$116	<p><b>Pineapple Finial</b></p>  <p>p. 12</p> <p>For 2" or 2¼" Poles <b>DF070-2</b> 6¼" L x 3⅝" H</p> <p>For 3" Poles <b>DF070-3</b> 6⅞" L x 3⅝" H</p> <p>Finish Group</p> <table border="1"> <thead> <tr> <th>A</th> <th>B</th> <th>C</th> </tr> </thead> <tbody> <tr> <td>\$66</td> <td>\$88</td> <td>\$108</td> </tr> </tbody> </table>	A	B	C	\$66	\$88	\$108	<p><b>Pinwheel Finial</b></p>  <p>p. 13</p> <p>For 2" or 2¼" Poles <b>DF524-2</b> 6¾" L x 3¾" H</p> <p>For 3" Poles <b>DF524-3</b> 7⅜" L x 3¾" H</p> <p>Finish Group</p> <table border="1"> <thead> <tr> <th>A</th> <th>B</th> <th>C</th> </tr> </thead> <tbody> <tr> <td>\$74</td> <td>\$96</td> <td>\$116</td> </tr> </tbody> </table>	A	B	C	\$74	\$96	\$116	<p><b>Prestige Finial</b></p>  <p> p. 13</p> <p>For 2" or 2¼" Poles <b>DF505-2</b> 6¾" L x 4¼" H</p> <p>For 3" Poles <b>DF505-3</b> 7⅜" L x 4¼" H</p> <p>Finish Group</p> <table border="1"> <thead> <tr> <th>A</th> <th>B</th> <th>C</th> </tr> </thead> <tbody> <tr> <td>\$84</td> <td>\$106</td> <td>\$128</td> </tr> </tbody> </table>	A	B	C	\$84	\$106	\$128
A	B	C																									
\$74	\$96	\$116																									
A	B	C																									
\$66	\$88	\$108																									
A	B	C																									
\$74	\$96	\$116																									
A	B	C																									
\$84	\$106	\$128																									
<p><b>Royal Orb Finial</b></p>  <p>p. 13</p> <p>For 2" or 2¼" Poles <b>DF087-2</b> 5⅝" L x 3¾" H</p> <p>For 3" Poles <b>DF087-3</b> 6¼" L x 3¾" H</p> <p>Finish Group</p> <table border="1"> <thead> <tr> <th>A</th> <th>B</th> <th>C</th> </tr> </thead> <tbody> <tr> <td>\$58</td> <td>\$80</td> <td>\$102</td> </tr> </tbody> </table>	A	B	C	\$58	\$80	\$102	<p><b>Scroll Finial</b></p>  <p>p. 13</p> <p>For 2" or 2¼" Poles <b>DF530-2</b> 7" L x 4" H</p> <p>For 3" Poles <b>DF530-3</b> 7⅝" L x 4" H</p> <p>Finish Group</p> <table border="1"> <thead> <tr> <th>A</th> <th>B</th> <th>C</th> </tr> </thead> <tbody> <tr> <td>\$76</td> <td>\$98</td> <td>\$118</td> </tr> </tbody> </table>	A	B	C	\$76	\$98	\$118	<p><b>Sonnet Finial</b></p>  <p>p. 14</p> <p>For 2" or 2¼" Poles <b>DF527-2</b> 7" L x 3¾" H</p> <p>For 3" Poles <b>DF527-3</b> 7⅝" L x 3¾" H</p> <p>Finish Group</p> <table border="1"> <thead> <tr> <th>A</th> <th>B</th> <th>C</th> </tr> </thead> <tbody> <tr> <td>\$76</td> <td>\$98</td> <td>\$118</td> </tr> </tbody> </table>	A	B	C	\$76	\$98	\$118	<p><b>Tiara Finial</b></p>  <p>p. 14</p> <p>For 2" or 2¼" Poles <b>DF533-2</b> 6⅞" L x 4" H</p> <p>For 3" Poles <b>DF533-3</b> 6¾" L x 4" H</p> <p>Finish Group</p> <table border="1"> <thead> <tr> <th>A</th> <th>B</th> <th>C</th> </tr> </thead> <tbody> <tr> <td>\$78</td> <td>\$100</td> <td>\$120</td> </tr> </tbody> </table>	A	B	C	\$78	\$100	\$120
A	B	C																									
\$58	\$80	\$102																									
A	B	C																									
\$76	\$98	\$118																									
A	B	C																									
\$76	\$98	\$118																									
A	B	C																									
\$78	\$100	\$120																									



Available for Quick Ship. See pages 6-9.

# ROD-ENDERS





# ROD-ENDERS

## DETAILS

- Elegant, smaller finials called Rod-Enders were designed especially for tight corners or small spaces, while still complementing our traditional-size finials.
- Rod-Enders are offered in several lengths - from small sizes such as Sonnet (1") and Opera (1¼"), to larger sizes such as Concerto (3⅛") and Polonaise (3⅝").
- Plume and Petals Rod-Enders fit over the end of the rod like a sleeve.
- Most Rod-Enders may be used as flush mount for applications like medallions and rosettes.
- Please note our smallest Rod-Enders are not available with our Dual Finish System Accent Finishes.
- Due to the nature of hand-crafted items, Rod-Ender dimensions may vary slightly from piece to piece. Rod-Ender pairs will be matched as closely as possible when ordered.

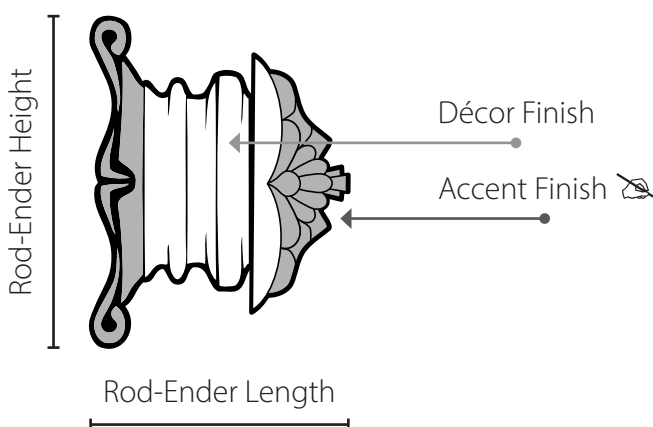

Select one of our **58 Décor Finishes** or our **Dual Finish System with 11 Accent Finishes** 

When ordering complete drapery hardware sets and accessories don't forget to include:

- Poles (1⅜", 2" 2¼" or 3") (pages 48-49)
- Brackets (pages 74-77 and 83-85)
- Rings (pages 80-82)
- Batons\* (page 79)
- Holdbacks\* (page 86)

\* *optional*

## SHIPPING & INSTALLATION NOTES

Rod-Enders come complete with screws for installing into wood. Orion wood poles are pre-drilled. Just screw the finial into the wood pole, and you are set for installation.

# 1 3/8" ROD-ENDERS

Rod-Enders for 1 3/8" diameter poles.

Not Available with Dual Finish System Accent Finishes.

**Blossom Rod-Ender**



p. 17

For 1 3/8" Poles  
**DE541-1**  
1 3/4" L x 2" H

Flush Mount Use: No

Finish Group

A	B	C
\$42	\$48	NA

**Plume Sleeve Rod-Ender**

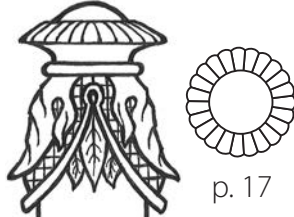

p. 17

For 1 3/8" Poles  
**DE513-1**  
2 3/4" L x 2" H

1 3/8" COVERS POLE : 1 3/8" PAST POLE

Flush Mount Use: No

Finish Group

A	B	C
\$56	\$64	NA

**Crest Rod-Ender**



p. 17

For 2" or 2 1/4" Poles  
**DE540X-2**  
2 1/2" L x 2 1/2" H

Flush Mount Use: Yes

Finish Group

A	B	C
\$50	\$56	NA

**Petals Sleeve Rod-Ender**

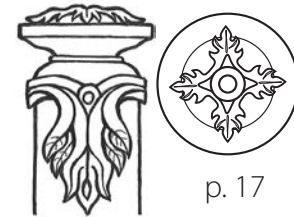

p. 17

For 2" or 2 1/4" Poles  
**DE525-2**  
4 3/4" L x 2 3/4" H

3" COVER POLES : 1 3/4" PAST POLE

Flush Mount Use: No

Finish Group

A	B	C
\$58	\$66	NA

# 2"-3"

Rod-Enders for 2", 2 1/4" and 3" diameter poles.

**Ballet Rod-Ender**

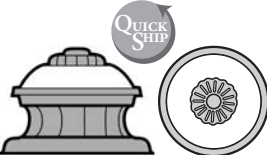

QUICK SHIP  
p. 18

For 2" or 2 1/4" Poles  
**DE049-2**  
2 5/8" L x 3 1/2" H

For 3" Poles  
**DE049-3**  
2 5/8" L x 3 1/2" H

Flush Mount Use: Yes

Finish Group

A	B	C
\$50	\$56	\$74

**Concerto Rod-Ender**

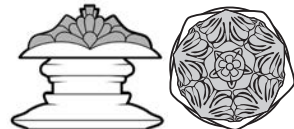

p. 18

For 2" or 2 1/4" Poles  
**DE045-2**  
3 1/8" L x 3 3/4" H

For 3" Poles  
**DE045-3**  
3 1/8" L x 3 3/4" H

Flush Mount Use: Yes

Finish Group

A	B	C
\$56	\$64	\$82

**Cotillion Rod-Ender**



p. 18

For 2" or 2 1/4" Poles  
**DE048-2**  
3 1/4" L x 3 7/8" H

For 3" Poles  
**DE048-3**  
3 1/4" L x 3 7/8" H

Flush Mount Use: Yes

Finish Group

A	B	C
\$52	\$58	\$76

**Encore Rod-Ender**



p. 19

For 2" or 2 1/4" Poles  
**DE052-2**  
2 3/4" L x 3 7/8" H

For 3" Poles  
**DE052-3**  
2 3/4" L x 3 7/8" H

Flush Mount Use: Yes

Finish Group

A	B	C
\$50	\$56	\$74



# ROD-ENDERS 2"-3"

Rod-Enders for 2", 2¼" and 3" diameter poles.

**Michele Rod-Ender Small**

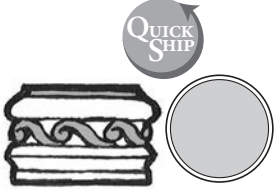

QUICK SHIP  
p. 19

For 2" or 2¼" Poles  
**DE598-2**  
1½" L x 3" H

Flush Mount Use: Yes

Finish Group

A	B	C
\$36	\$44	\$62

**Michele Rod-Ender Large**

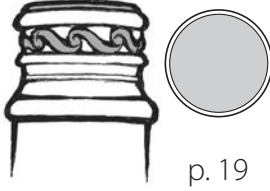

p. 19

For 3" Poles  
**DE594X-3**  
2⅛" L x 3⅜" H

Flush Mount Use: Yes

Finish Group

A	B	C
\$48	\$58	\$74

**Opera Rod-Ender**

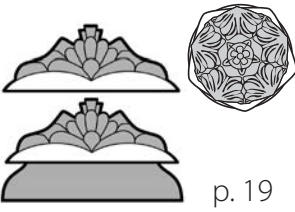

p. 19

Flush Mount Use: Yes

For 2" or 2¼" Poles  
**DE086-2**  
1¼" L x 4" H

Finish Group

A	B	C
\$46	\$50	\$66

For 3" Poles  
**DE580X-3**  
1⅞" L x 4" H

Finish Group

A	B	C
\$54	\$60	\$78

**Overture Rod-Ender**



p. 19

For 2" or 2¼" Poles  
**DE043-2**  
3¾" L x 4¼" H

For 3" Poles  
**DE043-3**  
3¾" L x 4¼" H

Flush Mount Use: No

Finish Group

A	B	C
\$58	\$66	\$84

**Polonaise Rod-Ender**

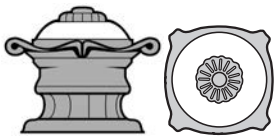

p. 20

For 2" or 2¼" Poles  
**DE042-2**  
3⅝" L x 4¼" H

For 3" Poles  
**DE042-3**  
3⅝" L x 4¼" H

Flush Mount Use: Yes

Finish Group

A	B	C
\$50	\$56	\$74

**Sonnet Rod-Ender**

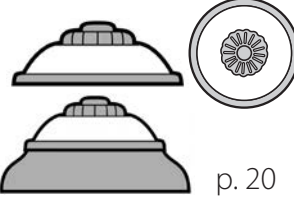

p. 20

Flush Mount Use: Yes

For 2" or 2¼" Poles  
**DE110-2**  
1" L x 3⅜" H

Finish Group

A	B	C
\$46	\$50	\$66

For 3" Poles  
**DE581X-3**  
1⅝" L x 3⅜" H

Finish Group

A	B	C
\$54	\$60	\$78

**Stanza Rod-Ender**

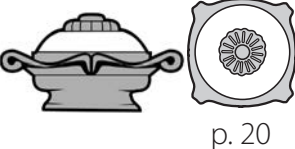

p. 20

For 2" or 2¼" Poles  
**DE053-2**  
2½" L x 4½" H

For 3" Poles  
**DE053-3**  
2½" L x 4½" H

Flush Mount Use: Yes

Finish Group

A	B	C
\$50	\$56	\$74

**Verse Rod-Ender**

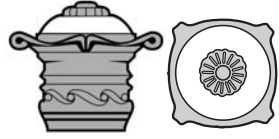

p. 20

For 2" or 2¼" Poles  
**DE044-2**  
3¾" L x 4⅜" H

For 3" Poles  
**DE044-3**  
3¾" L x 4⅜" H

Flush Mount Use: Yes

Finish Group

A	B	C
\$52	\$58	\$76



Available for Quick Ship. See pages 6-9.

# SWISSCRYSTAL-On-Wood



# SWISSCRYSTAL-On-Wood

## DETAILS

- Our sparkling hand-cut SwissCrystals are 24% lead.
- All SwissCrystals come with a Standard Base at no additional charge.  
Standard Base Measurements:  $\frac{5}{8}$ " L x  $2\frac{5}{8}$ " H for  $1\frac{3}{8}$ " poles, Iron U-Bend and Iron Post Holdbacks;  $\frac{5}{8}$ " L x  $3\frac{3}{8}$ " H for Wood Post and Pedestal Holdbacks, and 2",  $2\frac{1}{4}$ " or 3" poles.
- SwissCrystals can also be paired with Petite, Classic or Sculpted Bases (optional).
- Measurements shown are for SwissCrystal finials and do not include base dimensions. Please add base dimensions to get final measurement.
- Due to the nature of hand-made items, crystal designs and dimensions may vary slightly from piece to piece. SwissCrystal pairs will be matched as closely as possible when ordered.
- Brass knobs and stems may be left unpainted to match gold tones, painted silver to match silver tones, or painted to match your pole finish.

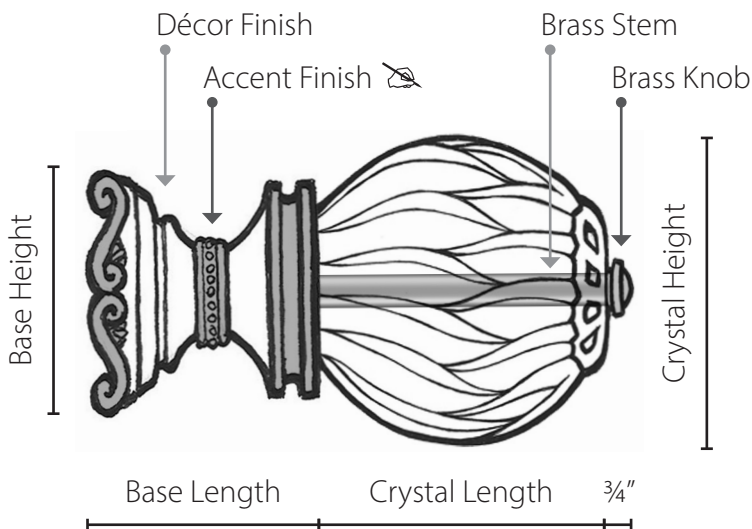

Select one of our **58 Décor Finishes** or our **Dual Finish System with 11 Accent Finishes**



All SwissCrystals come with a Standard Base at no additional charge.

When ordering complete drapery hardware sets and accessories don't forget to include:

- Poles ( $1\frac{3}{8}$ ", 2"  $2\frac{1}{4}$ " or 3") (pages 48-49)
- Rings (pages 80-82)
- Holdbacks\* (page 30)
- Brackets (pages 74-77 and 83-85)
- Batons\* (page 79)

\* optional

## SHIPPING & INSTALLATION NOTES

SwissCrystals come completely assembled with your selected base, including the screw for installing into wood. Orion wood poles are pre-drilled. Just screw the finial into the wood pole, and you are set for installation.



# SWISSCRYSTAL-On-Wood: Crystal Guide

Below is a list of all our SwissCrystal designs, some common dimensions, and which type of base each can be used with.

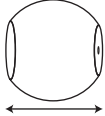
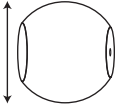
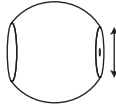
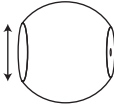
Crystal Name	Product #	Price List Page					Petite Base	Classic/ Sculpted Base
			Length	Height	Top	Bottom		
Aurora - 5"	DC801	24	4"	4 <sup>3</sup> / <sub>4</sub> "	2 <sup>1</sup> / <sub>4</sub> "	2 <sup>1</sup> / <sub>4</sub> "	No	Yes
Corona - 1 <sup>1</sup> / <sub>4</sub> " x 4 <sup>1</sup> / <sub>4</sub> "	DC802	24	1 <sup>1</sup> / <sub>4</sub> "	4 <sup>3</sup> / <sub>8</sub> "	4 <sup>3</sup> / <sub>8</sub> "	3 <sup>1</sup> / <sub>2</sub> "	No	Yes
Diamonds - 4"	DC803	23	3 <sup>1</sup> / <sub>4</sub> "	4"	2 <sup>1</sup> / <sub>8</sub> "	2 <sup>1</sup> / <sub>4</sub> "	Yes	Yes
Empress - 4"	DC804	23	3 <sup>7</sup> / <sub>8</sub> "	4"	1 <sup>5</sup> / <sub>8</sub> "	2"	Yes	Yes
Fascination - 4"	DC805	23	3 <sup>3</sup> / <sub>8</sub> "	4"	1 <sup>7</sup> / <sub>8</sub> "	2 <sup>1</sup> / <sub>4</sub> "	Yes	Yes
Halo - 1 <sup>1</sup> / <sub>4</sub> " x 4 <sup>1</sup> / <sub>4</sub> "	DC806	24	1 <sup>1</sup> / <sub>4</sub> "	4 <sup>3</sup> / <sub>8</sub> "	4 <sup>3</sup> / <sub>8</sub> "	3 <sup>1</sup> / <sub>2</sub> "	No	Yes
Heritage - 5 <sup>1</sup> / <sub>2</sub> " x 4"	DC807	23	5 <sup>5</sup> / <sub>8</sub> "	3 <sup>3</sup> / <sub>4</sub> "	1 <sup>1</sup> / <sub>4</sub> "	2 <sup>1</sup> / <sub>4</sub> "	Yes	Yes
Old Pinwheel - 6"	DC808	24	5"	5 <sup>3</sup> / <sub>4</sub> "	3 <sup>1</sup> / <sub>4</sub> "	2 <sup>1</sup> / <sub>4</sub> "	No	Yes
Petite Elise - 3"	DC809	23	3 <sup>1</sup> / <sub>8</sub> "	3 <sup>1</sup> / <sub>2</sub> "	1 <sup>5</sup> / <sub>8</sub> "	2"	Yes	Yes
Rainbow Arc - 4"	DC810	23	3 <sup>1</sup> / <sub>2</sub> "	3 <sup>7</sup> / <sub>8</sub> "	1 <sup>5</sup> / <sub>8</sub> "	2 <sup>1</sup> / <sub>4</sub> "	Yes	Yes
Royal Egyptian - 6"	DC811	24	5"	6"	2 <sup>7</sup> / <sub>8</sub> "	2 <sup>7</sup> / <sub>8</sub> "	No	Yes
Spring Flowers - 5"	DC812	24	4"	4 <sup>3</sup> / <sub>4</sub> "	2"	2 <sup>1</sup> / <sub>4</sub> "	No	Yes
Starburst - 4"	DC813	23	3 <sup>3</sup> / <sub>8</sub> "	4"	1 <sup>7</sup> / <sub>8</sub> "	2 <sup>1</sup> / <sub>4</sub> "	Yes	Yes
Timeless - 5"	DC814	24	4 <sup>1</sup> / <sub>8</sub> "	4 <sup>7</sup> / <sub>8</sub> "	2 <sup>1</sup> / <sub>8</sub> "	2 <sup>1</sup> / <sub>8</sub> "	No	Yes
Twinkle - 1 <sup>1</sup> / <sub>4</sub> " x 3"	DC815	23	1 <sup>3</sup> / <sub>8</sub> "	3 <sup>1</sup> / <sub>4</sub> "	N/A Rounded Top	2 <sup>1</sup> / <sub>8</sub> "	Yes	Yes
Windswept - 5"	DC816	24	4 <sup>1</sup> / <sub>8</sub> "	4 <sup>3</sup> / <sub>4</sub> "	2 <sup>1</sup> / <sub>4</sub> "	2 <sup>5</sup> / <sub>8</sub> "	No	Yes

SwissCrystal designs and dimensions may slightly vary due to the nature of hand-made items. SwissCrystal pairs will be matched as closely as possible when ordered.

A Standard Base comes with each SwissCrystal at no additional charge. Petite, Classic or Sculpted bases are optional.









Standard Base Measurements: <sup>5</sup>/<sub>8</sub>" L x 2<sup>5</sup>/<sub>8</sub>" H for 1<sup>3</sup>/<sub>8</sub>" poles, Iron U-Bend and Iron Post Holdbacks; <sup>5</sup>/<sub>8</sub>" L x 3<sup>3</sup>/<sub>8</sub>" H for Wood Post and Pedestal Holdbacks, and 2", 2<sup>1</sup>/<sub>4</sub>" or 3" poles.

# SWISSCRYSTAL-On-Wood: Crystals



## 3" and 4" diameter SwissCrystals

For use with any pole or in combination with Petite Bases (1 3/8" diameter poles), Classic Bases or Sculpted Bases (2", 2 1/4" and 3" diameter poles).

<p><b>Diamonds Crystal</b> <b>4" Diameter</b></p>  <p>p. 26-28, 30</p> <p>For 1 3/8" Poles <b>DC803-1</b> For 2" or 2 1/4" Poles <b>DC803-2</b> For 3" Poles <b>DC803-3</b> 3 1/4" L x 4" H BOTTOM OPENING: 2 1/4"</p> <p><b>Price:</b> \$148</p>	<p><b>Empress Crystal</b> <b>4" Diameter</b></p>  <p><b>QUICK SHIP</b> p. 27, 32</p> <p>For 1 3/8" Poles <b>DC804-1</b> For 2" or 2 1/4" Poles <b>DC804-2</b> For 3" Poles <b>DC804-3</b> 3 7/8" L x 4" H BOTTOM OPENING: 2"</p> <p><b>Price:</b> \$148</p>	<p><b>Fascination Crystal</b> <b>4" Diameter</b></p>  <p><b>QUICK SHIP</b> p. 23, 24, 26-28, 32</p> <p>For 1 3/8" Poles <b>DC805-1</b> For 2" or 2 1/4" Poles <b>DC805-2</b> For 3" Poles <b>DC805-3</b> 3 3/8" L x 4" H BOTTOM OPENING: 2 1/4"</p> <p><b>Price:</b> \$148</p>	<p><b>Heritage Crystal</b> <b>5 1/2" x 4"</b></p>  <p>p. 26, 27, 29, 32</p> <p>For 1 3/8" Poles <b>DC807-1</b> For 2" or 2 1/4" Poles <b>DC807-2</b> For 3" Poles <b>DC807-3</b> 5 5/8" L x 3 3/4" H BOTTOM OPENING: 2 1/4"</p> <p><b>Price:</b> \$218</p>
<p><b>Petite Elise Crystal</b> <b>3" Diameter</b></p>  <p><b>QUICK SHIP</b> p. 23, 25, 28, 29, 31</p> <p>For 1 3/8" Poles <b>DC809-1</b> For 2" or 2 1/4" Poles <b>DC809-2</b> For 3" Poles <b>DC809-3</b> 3 1/8" L x 3 1/2" H BOTTOM OPENING: 2"</p> <p><b>Price:</b> \$136</p>	<p><b>Rainbow Arc Crystal</b> <b>4" Diameter</b></p>  <p>p. 23, 24, 28, 30, 32</p> <p>For 1 3/8" Poles <b>DC810-1</b> For 2" or 2 1/4" Poles <b>DC810-2</b> For 3" Poles <b>DC810-3</b> 3 1/2" L x 3 7/8" H BOTTOM OPENING: 2 1/4"</p> <p><b>Price:</b> \$148</p>	<p><b>Starburst Crystal</b> <b>4" Diameter</b></p>  <p>p. 24, 25, 29, 31</p> <p>For 1 3/8" Poles <b>DC813-1</b> For 2" or 2 1/4" Poles <b>DC813-2</b> For 3" Poles <b>DC813-3</b> 3 3/8" L x 4" H BOTTOM OPENING: 2 1/4"</p> <p><b>Price:</b> \$148</p>	<p><b>Twinkle Crystal</b> <b>1 1/4" x 3"</b></p>  <p><b>QUICK SHIP</b> p. 23, 27</p> <p>For 1 3/8" Poles <b>DC815-1</b> For 2" or 2 1/4" Poles <b>DC815-2</b> For 3" Poles <b>DC815-3</b> 1 3/8" L x 3 1/4" H BOTTOM OPENING: 2 1/8"</p> <p><b>Price:</b> \$148</p>



Available for Quick Ship. See pages 6-9.



# SWISSCRYSTAL-On-Wood: Crystals

## 5" and 6" diameter SwissCrystals

For use with 2", 2¼" and 3" diameter poles or in combination with Classic or Sculpted Bases (2", 2¼" and 3" diameter poles).

### Aurora Crystal 5" Diameter



p. 25-28

For 2" or 2¼" Poles

**DC801-2**

For 3" Poles

**DC801-3**

4" L x 4¾" H

BOTTOM OPENING: 2¼"

**Price:**

\$148

### Corona Crystal 1¼" x 4¼"



p. 25

For 2" or 2¼" Poles

**DC802-2**

For 3" Poles

**DC802-3**

1¼" L x 4¾" H

BOTTOM OPENING: 3½"

**Price:**

\$154

### Halo Crystal 1¼" x 4¼"



p. 29,  
31

For 2" or 2¼" Poles

**DC806-2**

For 3" Poles

**DC806-3**

1¼" L x 4¾" H

BOTTOM OPENING: 3½"

**Price:**

\$154

### Old Pinwheel Crystal 6" Diameter



p. 25,  
27-29

For 2" or 2¼" Poles

**DC808-2**

For 3" Poles

**DC808-3**

5" L x 5¾" H

BOTTOM OPENING: 2¼"

**Price:**

\$228

### Royal Egyptian Crystal: 6" Dia.



p. 24,  
28,  
30,  
32

For 2" or 2¼" Poles

**DC811-2**

For 3" Poles

**DC811-3**

5" L x 6" H

BOTTOM OPENING: 2⅞"

**Price:**

\$216

### Spring Flowers Crystal: 5" Dia.



p. 24-26,  
31

For 2" or 2¼" Poles

**DC812-2**

For 3" Poles

**DC812-3**

4" L x 4¾" H

BOTTOM OPENING: 2¼"

**Price:**

\$148

### Timeless Crystal 5" Diameter



p. 29,  
30,  
32

For 2" or 2¼" Poles

**DC814-2**

For 3" Poles

**DC814-3**

4⅞" L x 4⅞" H

BOTTOM OPENING: 2⅞"

**Price:**

\$176

### Windswept Crystal 5" Diameter



p. 25,  
29,  
32

For 2" or 2¼" Poles

**DC816-2**

For 3" Poles

**DC816-3**

4⅞" L x 4¾" H

BOTTOM OPENING: 2⅞"

**Price:**

\$148



- SwissCrystal designs and dimensions may slightly vary due to the nature of hand-made items.
- SwissCrystal pairs will be matched as closely as possible when ordered.
- All SwissCrystals come with a Standard Base at no additional charge.  
Standard Base Measurements: ⅝" L x 2⅝" H for 1⅜" poles, Iron U-Bend and Iron Post Holdbacks;  
⅝" L x 3⅜" H for Wood Post and Pedestal Holdbacks, and 2", 2¼" or 3" poles.



# SWISSCRYSTAL-On-Wood: Base Guide



Below is a list of all our SwissCrystal-On-Wood bases, some common measurements, what type of base they are, and whether they are available as flush mount as used by Holdbacks or Stair Newels.

Base Name	Product Number	Price List Page	 Length	 Height	Category			Flush Mount / Stair Newel Compatible
					Petite Base	Classic Base	Sculpted Base	
Amanda	DY001	26	1½"	5¾"		X		Yes
Antique	DY072	28	2¼"	3"			X	Yes
Aria	DY038	26	1½"	3"		X		Yes
Ballade	DY510	28	3"	3¼"			X	Yes
Cadenza	DY599X	26	2⅛"	4½"		X		Yes
Caprice	DY503	28	3"	3"			X	Yes
Choir	DY080	26	1⅝"	5⅜"		X		No
Chorus	DY055	27	1⅝"	4½"		X		No
Dancer	DY612X	28	1⅝"	4"			X	Yes
Diva	DY560	28	3¾"	4⅛"			X	Yes
Grace	DY039	27	1⅜"	3⅝"		X		Yes
Grecian	DY099	26	1⅞"	2⅜"	X			No
Harmony	DY046	28	2⅞"	4½"			X	No
Lyric	DY519	28	3⅜"	3"			X	Yes
Medley	DY526	29	3⅛"	3½"			X	No
Music	DY407	27	2⅜"	3⅜"		X		Yes
Operetta	DY632	29	7⁄8"	3½"			X	Yes
Opus	DY542X	27	3⅝"	2⅞"		X		Yes
Orchestra	DY054	27	2"	3⅞"		X		Yes
Prelude	DY041	29	4⅜"	4¼"			X	No
Rhapsody	DY051	27	2⅛"	3⅞"		X		Yes
Sarah	DY003	29	1"	6"			X	Yes
Serenade	DY090	26	1½"	2⅝"	X			No
Sonata	DY409	29	2½"	4½"			X	Yes
Song	DY515	29	3⅛"	3"			X	Yes
Standard*	NA	21	⅝"	2⅝" / 3⅜"	X	X		Yes
Symphony	DY047	27	2½"	4¼"		X		Yes
Tenor	DY532	29	3"	3"			X	Yes

\*A Standard Base comes with each SwissCrystal at no additional charge.

Petite, Classic or Sculpted bases are optional.

Standard Base Measurements: ⅝" L x 2⅝" H for 1⅜" poles, Iron U-Bend and Iron Post Holdbacks; ⅝" L x 3⅜" H for Wood Post and Pedestal Holdbacks, and 2", 2¼" or 3" poles.



# SWISSCRYSTAL-On-Wood: Bases

Petite Bases for 1 3/8" diameter poles. For use with all 3" and 4" diameter SwissCrystal Finials.



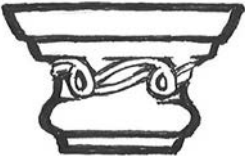

*Not Available with Dual Finish System Accent Finishes.*

Grecian Base			Serenade Base		
					
p. 23			p. 23		
For 1 3/8" Poles <b>DY099-1</b> 1 7/8" L x 2 3/8" H			For 1 3/8" Poles <b>DY090-1</b> 1 1/2" L x 2 5/8" H		
Flush Mount Use: No			Flush Mount Use: No		
Finish Group			Finish Group		
A	B	C	A	B	C
\$34	\$36	NA	\$48	\$50	NA

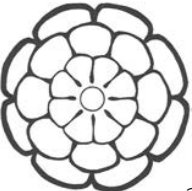

Classic Bases for 2", 2 1/4" and 3" poles. For use with all SwissCrystal Finials.

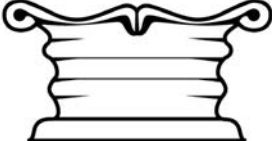
*Not Available with Dual Finish System Accent Finishes.*



Amanda Base			Aria Base			Cadenza Base			Choir Base		
											
p. 24			p. 24			p. 24			p. 25		
For 2" or 2 1/4" Poles <b>DY001-2</b> 1 1/2" L x 5 3/4" H			For 2" or 2 1/4" Poles <b>DY038-2</b> 1 1/2" L x 3" H			For 2" or 2 1/4" Poles <b>DY599X-2</b> 2 1/8" L x 4 1/2" H			For 2" or 2 1/4" Poles <b>DY080-2</b> 1 5/8" L x 5 3/8" H		
For 3" Poles <b>DY001-3</b> 1 1/2" L x 5 3/4" H			For 3" Poles <b>DY038-3</b> 1 1/2" L x 3" H			For 3" Poles <b>DY599X-3</b> 2 1/8" L x 4 1/2" H			For 3" Poles <b>DY080-3</b> 1 5/8" L x 5 3/8" H		
Flush Mount Use: Yes			Flush Mount Use: Yes			Flush Mount Use: Yes			Flush Mount Use: No		
Finish Group			Finish Group			Finish Group			Finish Group		
A	B	C	A	B	C	A	B	C	A	B	C
\$58	\$60	NA	\$44	\$46	NA	\$54	\$56	NA	\$40	\$42	NA



# SWISSCRYSTAL-On-Wood: Bases

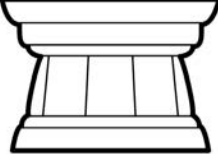

Classic Bases for 2", 2¼" and 3" diameter poles. For use with all SwissCrystal Finials.

*Not Available with Dual Finish System Accent Finishes.*

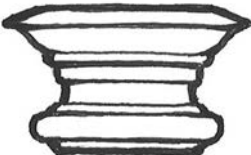
Chorus Base			Grace Base			Music Base		
								
p. 25			p. 25			p. 25		
For 2" or 2¼" Poles <b>DY055-2</b> 1⅝" L x 4½" H			For 2" or 2¼" Poles <b>DY039-2</b> 1⅜" L x 3⅝" H			For 2" or 2¼" Poles <b>DY407-2</b> 2⅜" L x 3⅜" H		
For 3" Poles <b>DY055-3</b> 1⅝" L x 4½" H			For 3" Poles <b>DY039-3</b> 1⅜" L x 3⅝" H			For 3" Poles <b>DY407-3</b> 2⅜" L x 3⅜" H		
Flush Mount Use: No			Flush Mount Use: Yes			Flush Mount Use: Yes		
Finish Group			Finish Group			Finish Group		
A	B	C	A	B	C	A	B	C
\$42	\$44	NA	\$40	\$42	NA	\$58	\$60	NA

Opus Base			Orchestra Base			Rhapsody Base			Symphony Base		
											
p. 26			p. 26			p. 26			p. 26		
For 2" or 2¼" Poles <b>DY542X-2</b> 3⅝" L x 2⅞" H			For 2" or 2¼" Poles <b>DY054-2</b> 2" L x 3⅞" H			For 2" or 2¼" Poles <b>DY051-2</b> 2⅛" L x 3⅞" H			For 2" or 2¼" Poles <b>DY047-2</b> 2½" L x 4¼" H		
For 3" Poles <b>DY542X-3</b> 4¼" L x 3⅜" H			For 3" Poles <b>DY054-3</b> 2" L x 3⅞" H			For 3" Poles <b>DY051-3</b> 2⅛" L x 3⅞" H			For 3" Poles <b>DY047-3</b> 2½" L x 4¼" H		
Flush Mount Use: Yes			Flush Mount Use: Yes			Flush Mount Use: Yes			Flush Mount Use: Yes		
Finish Group			Finish Group			Finish Group			Finish Group		
A	B	C	A	B	C	A	B	C	A	B	C
\$94	\$98	NA	\$46	\$48	NA	\$46	\$48	NA	\$58	\$60	NA



# SWISSCRYSTAL-On-Wood: Bases

Sculpted Bases for 2", 2¼" and 3" diameter poles. For use with all SwissCrystal Finials.

**Antique Base**



p. 27

For 2" or 2¼" Poles  
**DY072-2**  
2¼" L x 3" H

For 3" Poles  
**DY072-3**  
2¼" L x 3" H

Flush Mount Use: Yes

Finish Group

A	B	C
\$52	\$54	\$76

**Ballade Base**



p. 27

For 2" or 2¼" Poles  
**DY510-2**  
3" L x 3¼" H

For 3" Poles  
**DY510-3**  
3" L x 3¼" H

Flush Mount Use: Yes

Finish Group

A	B	C
\$66	\$68	\$96

**Caprice Base**



p. 27

For 2" or 2¼" Poles  
**DY503-2**  
3" L x 3" H

For 3" Poles  
**DY503-3**  
3" L x 3" H

Flush Mount Use: Yes

Finish Group

A	B	C
\$54	\$56	\$78

**Dancer Base**

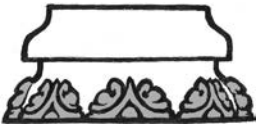

p. 27

For 2" or 2¼" Poles  
**DY612X-2**  
1½" L x 4" H

For 3" Poles  
**DY612X-3**  
1½" L x 4" H

Flush Mount Use: Yes

Finish Group

A	B	C
\$56	\$58	\$80

**Diva Base**



p. 28

For 2" or 2¼" Poles  
**DY560-2**  
3¾" L x 4½" H

For 3" Poles  
**DY560-3**  
3¾" L x 4½" H

Flush Mount Use: Yes

Finish Group

A	B	C
\$78	\$82	\$110

**Harmony Base**

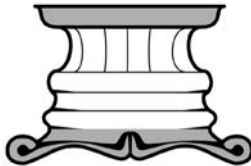

p. 28

For 2" or 2¼" Poles  
**DY046-2**  
2⅞" L x 4½" H

For 3" Poles  
**DY046-3**  
2⅞" L x 4½" H

Flush Mount Use: No

Finish Group

A	B	C
\$52	\$54	\$76

**Lyric Base**



p. 28

For 2" or 2¼" Poles  
**DY519-2**  
3⅜" L x 3" H

For 3" Poles  
**DY519-3**  
3⅜" L x 3" H

Flush Mount Use: Yes



Finish Group





A	B	C
\$58	\$60	\$86

# SWISSCRYSTAL-On-Wood: Bases



Sculpted Bases for 2", 2¼" and 3" diameter poles. For use with all SwissCrystal Finials.

Medley Base			Operetta Base			Prelude Base		
								
p. 28			p. 29			p. 29		
For 2" or 2¼" Poles <b>DY526-2</b> 3⅛"L x 3½"H			For 2" or 2¼" Poles <b>DY632-2</b> 7⁄8"L x 3½"H			For 2" or 2¼" Poles <b>DY041-2</b> 4⅜"L x 4¼"H		
For 3" Poles <b>DY526-3</b> 3⅛"L x 3½"H			For 3" Poles <b>DY632-3</b> 7⁄8"L x 3½"H			For 3" Poles <b>DY041-3</b> 4⅜"L x 4¼"H		
Flush Mount Use: No			Flush Mount Use: Yes			Flush Mount Use: No		
Finish Group			Finish Group			Finish Group		
A	B	C	A	B	C	A	B	C
\$56	\$58	\$80	\$44	\$46	\$64	\$56	\$58	\$80

Sarah Base			Sonata Base			Song Base			Tenor Base		
											
p. 29			p. 29			p. 30			p. 30		
For 2" or 2¼" Poles <b>DY003-2</b> 1"L x 6"H			For 2" or 2¼" Poles <b>DY409-2</b> 2½"L x 4½"H			For 2" or 2¼" Poles <b>DY515-2</b> 3⅛"L x 3"H			For 2" or 2¼" Poles <b>DY532-2</b> 3"L x 3"H		
For 3" Poles <b>DY003-3</b> 1"L x 6"H			For 3" Poles <b>DY409-3</b> 2½"L x 4½"H			For 3" Poles <b>DY515-3</b> 3⅛"L x 3"H			For 3" Poles <b>DY532-3</b> 3"L x 3"H		
Flush Mount Use: Yes			Flush Mount Use: Yes			Flush Mount Use: Yes			Flush Mount Use: Yes		
Finish Group			Finish Group			Finish Group			Finish Group		
A	B	C	A	B	C	A	B	C	A	B	C
\$56	\$58	\$80	\$48	\$50	\$72	\$58	\$60	\$86	\$56	\$58	\$80



# CRYSTAL-On-Wood: Holdbacks

Holdback options for SwissCrystal-On-Wood and Bohemia-On-Wood Finials.

- Iron U-Bend Holdbacks are available with a 3½" projection.
- Iron Post Holdbacks are available with 3", 4" or 6½" projections.
- Wood Post and Pedestal Holdbacks are available with 2½", 4", or 6" projections with a smooth or fluted 2" diameter pole. Custom projections up to 12" are available at no additional charge. Please call for a quote for projections over 12".
- Only Pedestal Holdbacks are available with Dual Finish System Accent Finishes. All other Holdbacks are finished in the Décor Finish.
- SwissCrystals may be used on any Holdback using their Standard Base, or with any Petite, Classic or Sculpted Base. Bohemia Crystals will include their metal collar.
- SwissCrystals may be used with a flush mount depending on their base. Please see the Base Guide on page 25 for available bases.
- Holdbacks are shipped assembled with their selected crystal finial and base.
- Iron Post and Wood Post Holdbacks include a mounting plate.



## Iron U-Bend Holdback

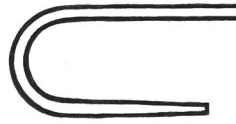

p. 31

8 ½" LONG

½" DIAMETER

3½" Projection  
**DM1087**

Finish Group

A	B	C
\$24	\$28	NA

## Iron Post Holdback

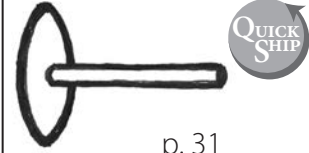

p. 31

BACKPLATE: 3⅛" DIAMETER

3" Projection  
**DM1088-300**

4" Projection  
**DM1088-400**

6½" Projection  
**DM1088-650**

Finish Group

A	B	C
\$20	\$22	NA

## Smooth Wood Post Holdback

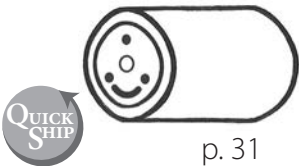

p. 31

2" DIAMETER POLE

2½" Projection  
**DM1090-SM-250**

4" Projection  
**DM1090-SM-400**

6" Projection  
**DM1090-SM-600**

Custom Projection  
**DM1090-SM-CUST**

Finish Group

A	B	C
\$24	\$28	NA

## Fluted Wood Post Holdback

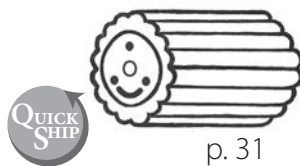

p. 31

2" DIAMETER POLE

2½" Projection  
**DM1090-FL-250**

4" Projection  
**DM1090-FL-400**

6" Projection  
**DM1090-FL-600**

Custom Projection  
**DM1090-FL-CUST**

Finish Group

A	B	C
\$24	\$28	NA

## Pedestal Holdback with Smooth Wood

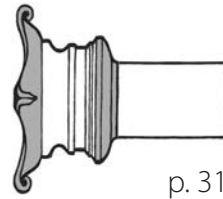

p. 31

2" DIAMETER POLE

2½" L x 4½" H BASE

2½" Projection (base)  
**DM111-250**

4" Projection  
**DM111-SM-400**

6" Projection  
**DM111-SM-600**

Custom Projection  
**DM111-SM-CUST**

Finish Group

A	B	C
\$46	\$54	\$62

## Pedestal Holdback with Fluted Wood

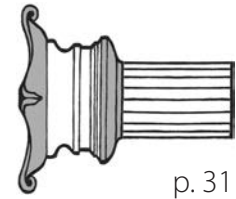

p. 31

2" DIAMETER POLE

2½" L x 4½" H BASE

2½" Projection (base)  
**DM111-250**

4" Projection  
**DM111-FL-400**

6" Projection  
**DM111-FL-600**

Custom Projection  
**DM111-FL-CUST**

Finish Group





A	B	C
\$46	\$54	\$62

# SWISSCRYSTAL-On-Wood: Medallions



Medallion options for SwissCrystal-On-Wood Finials.

- Any SwissCrystal may be used with the Medallion bases below.
- Medallion bases may be used flush mount or with a Wood Post Holdback (DM1090).
- Standard post projections are 2½", 4" or 6" on a 2" diameter smooth or fluted pole.
- Custom projections up to 12" are available at no additional charge. Please call for a quote for projections over 12".
- Medallions are shipped assembled with their selected SwissCrystal and Wood Post Holdback (if applicable).
- Medallions include a mounting plate.

Bard Base			Bravo Base			Melody Base			Minstrel Base		
											
p. 32			p. 32			p. 32			p. 32		
<b>DM611X</b>			<b>DM085</b>			<b>DM094</b>			<b>DM596X</b>		
3¾" L x 7¾" H			1¼" L x 7¾" H			1" L x 8" H			3¾" L x 8" H		
Flush Mount Use: Yes			Flush Mount Use: Yes			Flush Mount Use: Yes			Flush Mount Use: Yes		
Finish Group			Finish Group			Finish Group			Finish Group		
<b>A</b>	<b>B</b>	<b>C</b>	<b>A</b>	<b>B</b>	<b>C</b>	<b>A</b>	<b>B</b>	<b>C</b>	<b>A</b>	<b>B</b>	<b>C</b>
\$86	\$90	\$108	\$64	\$66	\$82	\$64	\$66	\$82	\$86	\$90	\$108

See Bravo Base for top down illustration view.

See Melody Base for top down illustration view.

# SWISSCRYSTAL-On-Wood: Stair Newels



Add coordinating accents using SwissCrystal-On-Wood Finials.

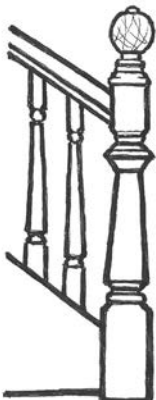

Elegant crystals have graced the stair newel posts of fine homes for centuries. Create your own Crystal Stair Newel Finials to coordinate with your drapery hardware by combining any SwissCrystal with any flush mountable SwissCrystal Base. Please see the Base Guide on page 25 for available bases.





# SWISSCRYSTAL-ON-IRON

## DETAILS

- Contemporary 1 1/4" iron rods showcase hand-cut 24% lead SwissCrystal Finials.
- All SwissCrystals come with a Standard Base at no additional charge.  
Standard Base Measurements: 5/8" L x 2 5/8" H for 1 1/4" Iron rods, Iron U-Bend and Iron Post Holdbacks.
- Iron rods, rings, brackets, batons and holdbacks are only available in 5 iron finishes: Metal Ore, Modern Gold, Oil Rubbed Bronze, Brushed Nickel and Chrome.
- 5 SwissCrystal Finials are available on 5 bases. The Standard Base is included in the Finial price. The 5 bases are only available in 5 Décor Finishes: Antique Bronze, Royal Red, Silver Shimmer, Urbane Bronze or Zinc.
- Due to the nature of hand-made items, crystal designs and dimensions may vary slightly from piece to piece. SwissCrystal pairs will be matched as closely as possible when ordered.
- Brass knobs and stems may be left unpainted to match gold tones, painted silver to match silver tones, or painted to match your base finish.

Iron Finishes for Rods, Rings,  
Brackets, Batons and Holdbacks.

Iron Finishes	Code / Finish	Group	Sheen
Metal Ore	DP935D	D	Matte
Modern Gold	DP938D	D	Matte
Oil Rubbed Bronze	DP934D	D	Matte
Brushed Nickel	DP958E	E	Matte
Chrome	DP959F	F	NA

Décor Finishes for  
SwissCrystal-On-Iron Bases.

Décor Finishes	Code / Finish	Group	Sheen
Antique Bronze	DP902A	A	Matte
Royal Red	DP942A	A	Matte
Silver Shimmer	DP947A	A	Matte
Urbane Bronze	DP951A	A	Matte
Zinc	DP957B	B	Matte

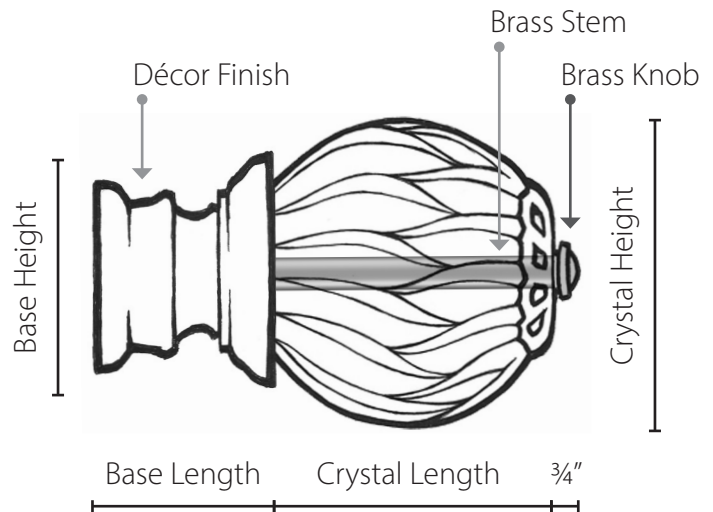

Select one these **5 Décor Finishes** only:  
Antique Bronze, Royal Red, Silver Shimmer,  
Urbane Bronze or Zinc.

When ordering complete drapery hardware sets and accessories don't forget to include:

- 1 1/4" Rods (page 34)
- Rings (page 35)
- Holdbacks\* (page 35)
- Brackets (page 35)
- Baton\* (page 35)

\* optional

## SHIPPING & INSTALLATION NOTES

SwissCrystals come completely assembled with your selected base, including the adaptor for installing into hollow round iron rods. Orion rods are pre-drilled for set screws Just insert the finial into the rod, tighten the set screw, and you are set for installation.



# SWISSCRYSTAL-On-Iron: Crystal



## 3" and 4" diameter Crystals

For use with 1 1/4" iron rods or in combination with SwissCrystal-On-Iron Bases.

### Diamonds Crystal 4" Diameter



p. 33

For 1 1/4" Rods

**DC803**

3 1/4" L x 4" H

BOTTOM OPENING: 2 1/4"

**Price:**

\$148

### Fascination Crystal 4" Diameter



p. 33

For 1 1/4" Rods

**DC805**

3 3/8" L x 4" H

BOTTOM OPENING: 2 1/4"

**Price:**

\$148

### Petite Elise Crystal 3" Diameter



p. 34

For 1 1/4" Rods

**DC809**

3 1/8" L x 3 1/2" H

BOTTOM OPENING: 2"

**Price:**

\$136

### Rainbow Arc Crystal 4" Diameter



p. 34

For 1 1/4" Rods

**DC810**

3 1/2" L x 3 7/8" H

BOTTOM OPENING: 2 1/4"

**Price:**

\$148

### Twinkle Crystal 1 1/4" x 3"



p. 33

For 1 1/4" Rods

**DC815**

1 3/8" L x 3 1/4" H

BOTTOM OPENING: 2 1/8"

**Price:**

\$148



All SwissCrystals come with a Standard Base at no additional charge.

- SwissCrystal designs and dimensions may slightly vary due to the nature of hand-made items.
- SwissCrystal pairs will be matched as closely as possible when ordered.
- All SwissCrystals come with a Standard Base at no additional charge.  
Standard Base Measurements: 5/8" L x 2 5/8" H for 1 1/4" rods, and Iron U-Bend and Iron Post Holdbacks.



# SWISSCRYSTAL-On-Iron: Bases

Bases for 1 1/4" rods. For use with SwissCrystal-On-Iron Finials.

Available in these 5 Décor Finishes only: Antique Bronze, Royal Red, Silver Shimmer, Urbane Bronze or Zinc.

Allure Base	Charm Base	Crown Base	Simplicity Base
			
p. 33	p. 34	p. 33	p. 34
For 1 1/4" Rods <b>DY609X</b> 2 1/4" L x 2 1/2" H	For 1 1/4" Rods <b>DY575</b> 1 1/8" L x 2 1/8" H	For 1 1/4" Rods <b>DY610X</b> 1 3/4" L x 2" H	For 1 1/4" Rods <b>DY577</b> 1 7/8" L x 2 3/8" H
Flush Mount Use: No	Flush Mount Use: No	Flush Mount Use: No	Flush Mount Use: No
Finish Group	Finish Group	Finish Group	Finish Group
<b>Price:</b>	<b>Price:</b>	<b>Price:</b>	<b>Price:</b>
\$58	\$52	\$66	\$58

p. 33  All SwissCrystals come with a Standard Base at no additional charge.

## Iron rods for the SwissCrystal-On-Iron collection.

Available in 5 iron finishes: Metal Ore (D), Modern Gold (D), Oil Rubbed Bronze (D), Brushed Nickel (E) and Chrome (F).

- Iron rods are available in 10' (120") lengths without a splice. By default, we splice any iron rod over 8'10" (106") to save on shipping charges using FedEx. (New FedEx surcharge above 96" in length per box will be added in addition to the shipping and handling charges.) Rods not specified as one piece in the order will be spliced in the center, unless a splice location is otherwise noted. Anything over 8'10" (106") must be shipped by common carrier (truck line). Please note residential truck deliveries are restricted to 24' (288").
- Rods can be bent or curved for special applications. Please add product DM102 to the order.
- Rods can be spliced together to provide any length using a rod connector. Please add product DM300 to the order.
- Rods can be mitered for splices, corners, and special applications like bay windows. Please add product DM307 to the order.
- If applicable, please specify rod deductions for bay windows, arches, and bent rods.
- As a general guideline, we recommend brackets every 4 feet.

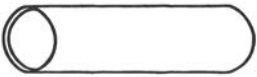

Iron Rod													
Finish Group	Unit	2 Feet	3 Feet	4 Feet	5 Feet	6 Feet	7 Feet	8 Feet	9 Feet	10 Feet	11 Feet	12 Feet	Addl. Foot
<b>DIR - Smooth Hollow Iron Rod: 1 1/4" Diameter</b>													
D	EACH	\$40	\$60	\$80	\$100	\$120	\$140	\$160	\$180	\$200	\$220	\$240	\$20
E	EACH	\$64	\$96	\$128	\$160	\$192	\$224	\$256	\$288	\$320	\$352	\$384	\$32
F	EACH	\$78	\$117	\$156	\$195	\$234	\$273	\$312	\$351	\$390	\$429	\$468	\$39

# SWISSCRYSTAL-On-Iron: Accessories

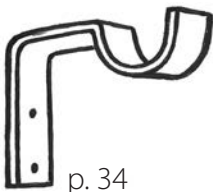
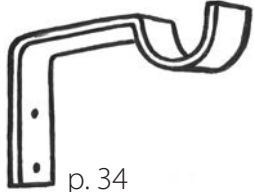
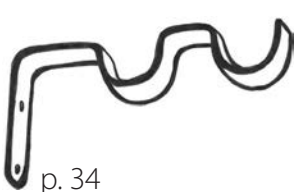

Iron hardware, accessories, and charges for the SwissCrystal-On-Iron collection.

Available in 5 iron finishes: Metal Ore (D), Modern Gold (D), Oil Rubbed Bronze (D), Brushed Nickel (E) and Chrome (F).

<b>Iron Bracket - 3"P</b>  p. 34 For 1 1/4" Diameter Rods <b>DB7014-125</b> 3" PROJECTION 1"W X 3 1/4"H  Finish Group <table border="1"> <tr><th>D</th><th>E</th><th>F</th></tr> <tr><td>\$26</td><td>\$39</td><td>\$46</td></tr> </table>			D	E	F	\$26	\$39	\$46	<b>Iron Bracket - 6"P</b>  p. 34 For 1 1/4" Diameter Rods <b>DB7015-125</b> 6" PROJECTION 1"W X 3 1/4"H  Finish Group <table border="1"> <tr><th>D</th><th>E</th><th>F</th></tr> <tr><td>\$34</td><td>\$42</td><td>\$50</td></tr> </table>			D	E	F	\$34	\$42	\$50	<b>Double Iron Bracket</b>  p. 34 For 1 1/4" Diameter Rods <b>DB7040-125</b> 3"/6" PROJECTION 1"W X 3 1/4"H  Finish Group <table border="1"> <tr><th>D</th><th>E</th><th>F</th></tr> <tr><td>\$38</td><td>\$58</td><td>\$70</td></tr> </table>			D	E	F	\$38	\$58	\$70	<b>Iron Ring</b>  p. 34 For 1 1/4" Diameter Rods <b>DG350-125</b> 1/4" THICK 1 3/4" INNER DIAMETER 2 1/4" OUTER DIAMETER  Finish Group <table border="1"> <tr><th>D</th><th>E</th><th>F</th></tr> <tr><td>\$6</td><td>\$9</td><td>\$10</td></tr> </table>			D	E	F	\$6	\$9	\$10
D	E	F																																	
\$26	\$39	\$46																																	
D	E	F																																	
\$34	\$42	\$50																																	
D	E	F																																	
\$38	\$58	\$70																																	
D	E	F																																	
\$6	\$9	\$10																																	

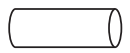
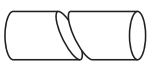
<b>Bend Charge</b>  For Iron Rods <b>DM102</b> Custom angles and curves. Please provide a template. <b>Price Per Foot: \$18</b>	
<b>Rod Connector</b>  Connects Spliced Rods <b>DM300</b> 8"L X 1 1/8"H <b>Price Each: \$16</b>	
<b>Miter Cut</b>  For Rods <b>DM307</b> For splices, corners, and special applications like bay windows. <b>Price Each: \$14</b>	

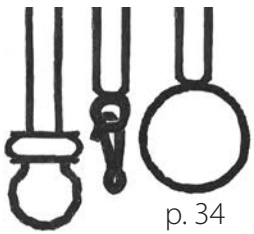
<b>Iron Round Baton</b>  p. 34 Please Specify Ring or Clip <b>DM1014</b> 1/2" DIAMETER : 5/8" AFTER 73" Custom Lengths Available Additional Clips Available for \$2.00 each, Item #DM1022 <table border="1"> <tr><th>Length</th><th colspan="3">Finish Group</th></tr> <tr><th></th><th>D</th><th>E</th><th>F</th></tr> <tr><td>12"-24"</td><td>\$48</td><td>\$66</td><td>\$76</td></tr> <tr><td>25"-48"</td><td>\$56</td><td>\$80</td><td>\$90</td></tr> <tr><td>49"-72"</td><td>\$74</td><td>\$96</td><td>\$114</td></tr> <tr><td>73"-84"</td><td>\$92</td><td>\$134</td><td>\$148</td></tr> <tr><td>85"-108"</td><td>\$112</td><td>\$142</td><td>\$168</td></tr> </table>				Length	Finish Group				D	E	F	12"-24"	\$48	\$66	\$76	25"-48"	\$56	\$80	\$90	49"-72"	\$74	\$96	\$114	73"-84"	\$92	\$134	\$148	85"-108"	\$112	\$142	\$168
Length	Finish Group																														
	D	E	F																												
12"-24"	\$48	\$66	\$76																												
25"-48"	\$56	\$80	\$90																												
49"-72"	\$74	\$96	\$114																												
73"-84"	\$92	\$134	\$148																												
85"-108"	\$112	\$142	\$168																												

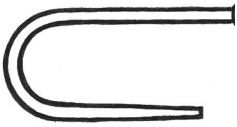
<b>Iron U-Bend Holdback</b>  p. 34 3 1/2" Projection <b>DM1087</b> 8 1/2" LONG 1/2" DIAMETER  Finish Group <table border="1"> <tr><th>D</th><th>E</th><th>F</th></tr> <tr><td>\$34</td><td>\$42</td><td>\$46</td></tr> </table>			D	E	F	\$34	\$42	\$46
D	E	F						
\$34	\$42	\$46						

<b>Iron Post Holdback</b>  p. 34 BACKPLATE: 3 1/8" DIAMETER 3" Projection <b>DM1088-300</b> 4" Projection <b>DM1088-400</b> 6 1/2" Projection <b>DM1088-650</b> Finish Group <table border="1"> <tr><th>D</th><th>E</th><th>F</th></tr> <tr><td>\$36</td><td>\$44</td><td>\$48</td></tr> </table>			D	E	F	\$36	\$44	\$48
D	E	F						
\$36	\$44	\$48						

- SwissCrystal-On-Iron may be used on Iron U-Bend or Iron Post Holdbacks using their Standard Base, or with any SwissCrystal-On-Iron Base.
- Holdbacks are shipped assembled with their selected crystal finial and base.
- Iron Post Holdbacks include a mounting plate.



# BOHEMIA CRYSTAL-On-Wood

**DETAILS** Bohemia Crystal features 16 styles of hand-crafted faceted crystal-glass finials. They include a metal adaptor base in your choice of 58 Décor Finishes. 2 end cap designs fit 1 3/8" poles. 14 designs fit 1 3/8", 2" or 2 1/4" poles. All styles are available in 4 Holdback options as listed on page 30.



Bohemia Crystal for 1 3/8" poles.

*Not Available with Dual Finish System Accent Finishes.*



Bohemia Crystal for 1 3/8", 2" and 2 1/4" poles.

*Not Available with Dual Finish System Accent Finishes.*

## Gem Crystal



p. 35

1 1/4" L x 2 3/8" H

For 1 3/8" Poles  
**DC778-1**

Finish Group

A	B	C
\$70	\$78	NA

## Rondure Crystal



p. 35

3/4" L x 2" H

For 1 3/8" Poles  
**DC790-1**

Finish Group

A	B	C
\$62	\$68	NA

## Brilliant Block Crystal



p. 35

2 7/8" L x 2 3/4" H

For 1 3/8" Poles  
**DC782-1**  
For 2" or 2 1/4" Poles  
**DC782-2**

Finish Group

A	B	C
\$82	\$92	NA

## Crescent Crystal



p. 35

2 3/4" L x 2 3/8" H

For 1 3/8" Poles  
**DC772-1**  
For 2" or 2 1/4" Poles  
**DC772-2**

Finish Group

A	B	C
\$80	\$88	NA

## Dazzle Crystal



p. 35

3" L x 2 3/4" H

For 1 3/8" Poles  
**DC777-1**  
For 2" or 2 1/4" Poles  
**DC777-2**

Finish Group

A	B	C
\$86	\$96	NA

## Exquisite Crystal



p. 35

3 1/2" L x 2" H

For 1 3/8" Poles  
**DC787-1**  
For 2" or 2 1/4" Poles  
**DC787-2**

Finish Group

A	B	C
\$78	\$86	NA

## Facet Crystal



p. 35

2 3/8" L x 3 1/8" H

For 1 3/8" Poles  
**DC776-1**  
For 2" or 2 1/4" Poles  
**DC776-2**

Finish Group

A	B	C
\$80	\$88	NA

## Glisten Crystal



p. 35

2 3/8" L x 2 1/4" H

For 1 3/8" Poles  
**DC771-1**  
For 2" or 2 1/4" Poles  
**DC771-2**

Finish Group

A	B	C
\$72	\$80	NA



# BOHEMIA CRYSTAL-On-Wood

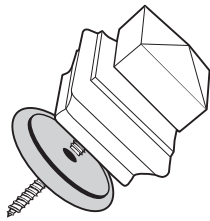









## SHIPPING & INSTALLATION NOTES

Bohemia Crystals are shipped in custom boxes, disassembled from their metal adaptor bases (which are welded to a screw for installing into wood). Orion wood poles are pre-drilled. Just screw the crystal into the metal adaptor base, and the metal adaptor base into the wood pole, and you are set for installation.



Bohemia Crystal for 1 3/8", 2" and 2 1/4" poles.

*Not Available with Dual Finish System Accent Finishes.*

Orb Crystal				Prism Crystal				Shimmer Crystal				Solitaire Crystal			
 <p>QUICK SHIP</p> <p>p. 36</p>				 <p>QUICK SHIP</p> <p>p. 36</p>				 <p>QUICK SHIP</p> <p>p. 36</p>				 <p>p. 36</p>			
<p>2 1/8" L x 2 3/8" H</p> <p>For 1 3/8" Poles <b>DC781-1</b></p> <p>For 2" or 2 1/4" Poles <b>DC781-2</b></p> <p>Finish Group</p>				<p>1 1/2" L x 3 1/8" H</p> <p>For 1 3/8" Poles <b>DC779-1</b></p> <p>For 2" or 2 1/4" Poles <b>DC779-2</b></p> <p>Finish Group</p>				<p>2 3/4" L x 2 3/8" H</p> <p>For 1 3/8" Poles <b>DC773-1</b></p> <p>For 2" or 2 1/4" Poles <b>DC773-2</b></p> <p>Finish Group</p>				<p>2" L x 2 3/4" H</p> <p>For 1 3/8" Poles <b>DC774-1</b></p> <p>For 2" or 2 1/4" Poles <b>DC774-2</b></p> <p>Finish Group</p>			
A	B	C		A	B	C		A	B	C		A	B	C	
\$64	\$70	NA		\$76	\$84	NA		\$80	\$88	NA		\$74	\$82	NA	
Sparkle Crystal				Stacked Crystal				Vortex Crystal				Whirl Crystal			
 <p>p. 36</p>				 <p>p. 36</p>				 <p>p. 36</p>				 <p>p. 36</p>			
<p>2 3/4" L x 2 1/2" H</p> <p>For 1 3/8" Poles <b>DC775-1</b></p> <p>For 2" or 2 1/4" Poles <b>DC775-2</b></p> <p>Finish Group</p>				<p>3 5/8" L x 3 5/8" H</p> <p>For 1 3/8" Poles <b>DC791-1</b></p> <p>For 2" or 2 1/4" Poles <b>DC791-2</b></p> <p>Finish Group</p>				<p>3 1/2" L x 2" H</p> <p>For 1 3/8" Poles <b>DC788-1</b></p> <p>For 2" or 2 1/4" Poles <b>DC788-2</b></p> <p>Finish Group</p>				<p>3 3/4" L x 3 1/4" H</p> <p>For 1 3/8" Poles <b>DC792-1</b></p> <p>For 2" or 2 1/4" Poles <b>DC792-2</b></p> <p>Finish Group</p>			
A	B	C		A	B	C		A	B	C		A	B	C	
\$90	\$100	NA		\$80	\$88	NA		\$78	\$86	NA		\$80	\$88	NA	



Available for Quick Ship. See pages 6-9.

# INLAY Designs

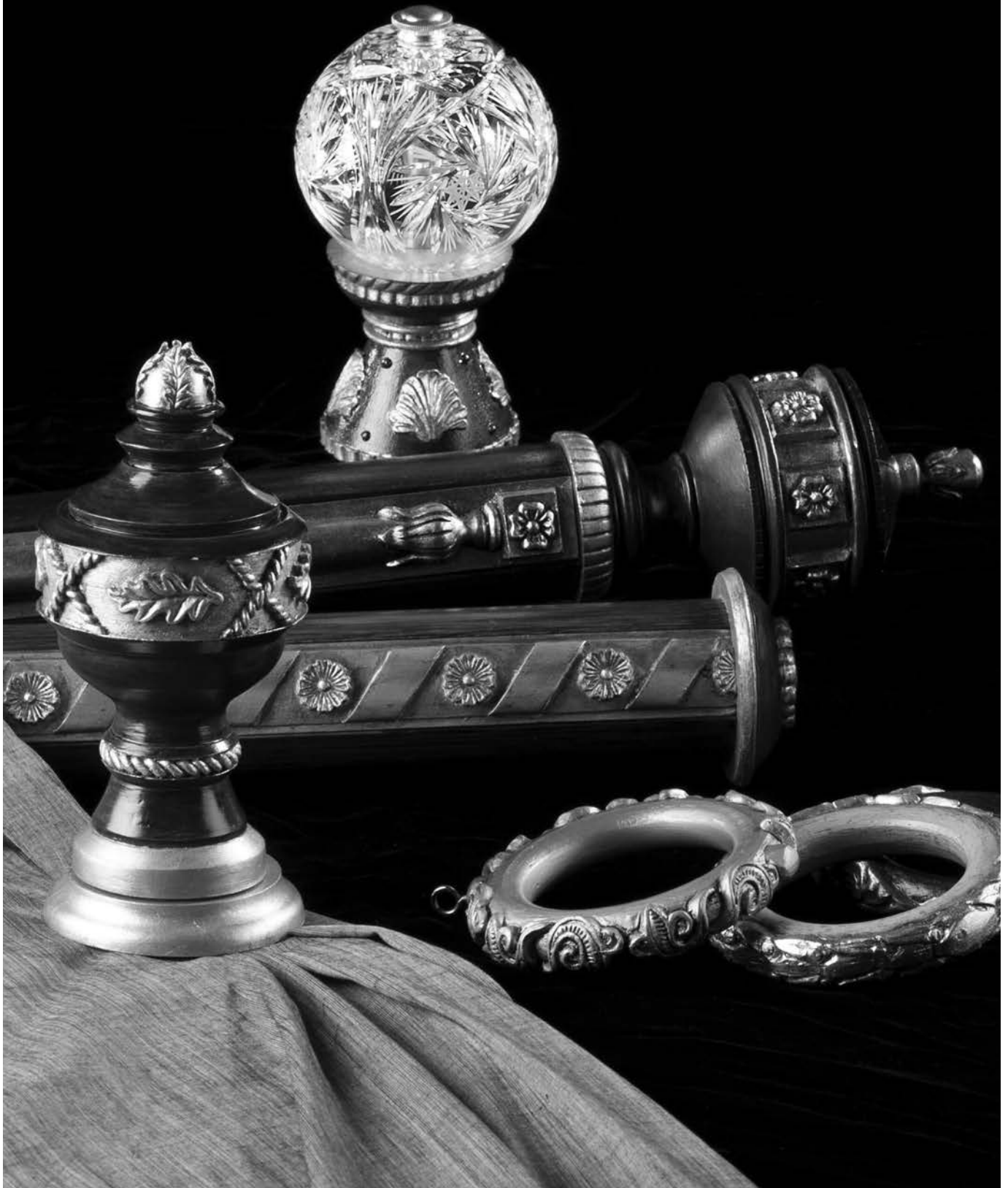

# INLAY Designs

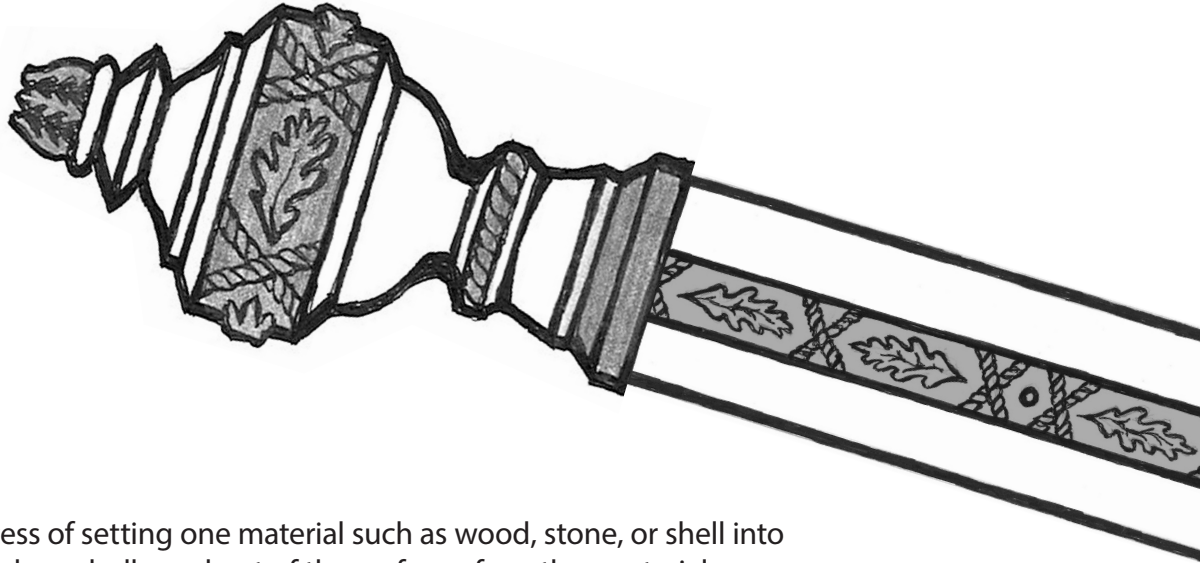

## DETAILS

- Inlay is the process of setting one material such as wood, stone, or shell into a cavity that has been hollowed out of the surface of another material.
- Our Inlay collection features 10 Inlay designs, 10 matching Finials, and 10 Decal designs.
- Inlay designs are available on 2¼" and 3" diameter poles and on the Inlay Bracket.
- Inlay designs come in two types of patterns: Continuous and Repeat.
- Each Inlay design has a matching finial.
- Each Inlay design has a matching Decal design.
- Decal designs are available for two finials, one SwissCrystal base, and one Decal Bracket.
- All Inlay Design collection items are available in any of our 58 Décor Finishes or our Dual Finish System with 11 Accent Finishes 🗑️.

When ordering complete drapery hardware sets and accessories don't forget to include:

- Inlay Poles (2¼" or 3") (page 41)
- Inlay or Decal Finials (pages 42-44)
- Inlay or Decal Brackets (page 45)
- Rings (pages 80-82)
- Batons\* (page 79)
- Holdbacks\* (page 86)

\*optional

## SHIPPING & INSTALLATION NOTES

- Orion wood poles are pre-drilled. Just screw the finial into the wood pole, and you are set for installation.
- Finials come complete with screws for installing into wood.
- SwissCrystals come completely assembled with Inlay Base, including the screw for installing into wood.

# INLAY Designs: Patterns

Inlay design patterns for 2¼" and 3" diameter Inlay Poles and Inlay Bracket.

*Inlay designs are available in Continuous Pattern and Repeat Pattern styles. When ordering, please include the Inlay design number along with the pole or bracket number.*

## Continuous Pattern Inlay Designs

- Come in 4 foot sections.
- Will be spliced together to run end to end on the pole and maintain the continuity of the pattern for poles over 4 feet long.
- Please see catalog pages 37-51 for examples.

## Repeat Pattern Inlay Designs

- Come in 4 foot sections.
- Have a 12" pattern repeat and are centered in the pole.
- Depending on the pole length, may run from end to end or there may be spaces on each end without Inlay.
- Please see catalog pages 37-51 for examples.

*Although Inlay designs come in 4 foot sections, the poles they are set into are available in continuous lengths up to 16 feet. Please see price list pages 47-49 for more information on ordering wood poles.*

*Continuous Pattern Inlay Designs run the entire length of the pole.*

*Repeat Pattern Inlay Designs are centered in the pole.*

**Autumn Inlay - DI502**

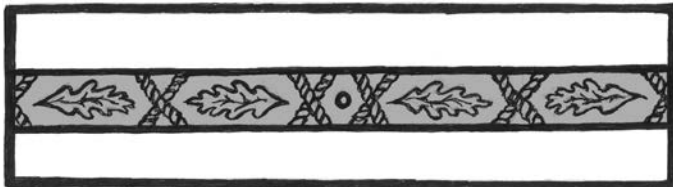

**Cameo Inlay - DI010**

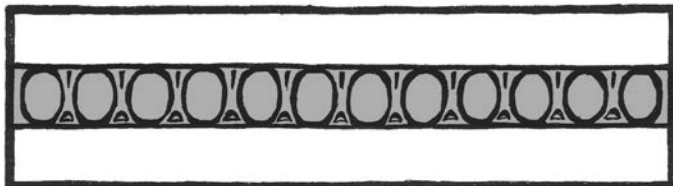

**Harvest Inlay - DI512**

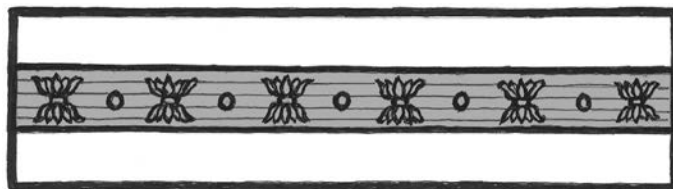

**Opera Inlay - DI517**

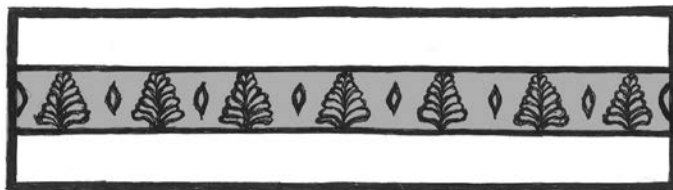

**Sonnet Inlay - DI529**

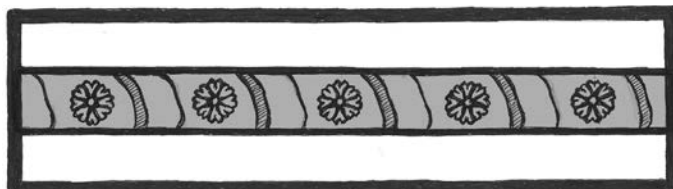

**Garland Inlay - DI508**

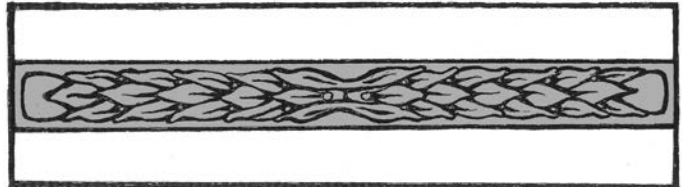

**Ornament Inlay - DI006**

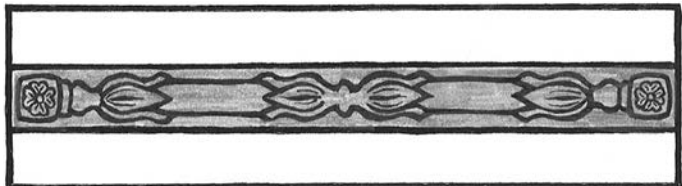

**Paisley Inlay - DI005**



**Pinwheel Inlay - DI008**



**Scroll Inlay - DI009**





# INLAY Designs: Poles

## Inlay Pole

*When ordering, please include the Inlay design number from page 40 along with the pole number.*

- The maximum continuous length for a wood pole is 16' (192"). We splice any wood pole with a Wood Pole Splice (DM5054 page 49) over 8'10" (106") to save on shipping charges using FedEx. *(New FedEx surcharge above 96" in length per box will be added in addition to the shipping and handling charges.)* Poles not specified as one piece in the order will be spliced in the center, unless splice location is otherwise noted. Anything over 8'10" (106") must be shipped by common carrier (truck line). Please contact customer service for details as delivery restrictions apply.
- Poles can be spliced together to provide any length using a Wood Pole Splice (Standard, Product DM5054) or Miter Splice (Please specify Product DM5055).
- Wood poles are available and priced in sections of 2', 4', 6', 8', 10', 12', 14' and 16'.
- Manual or motorized traversing poles are available up to 30' (360") in length (see pages 54-69).

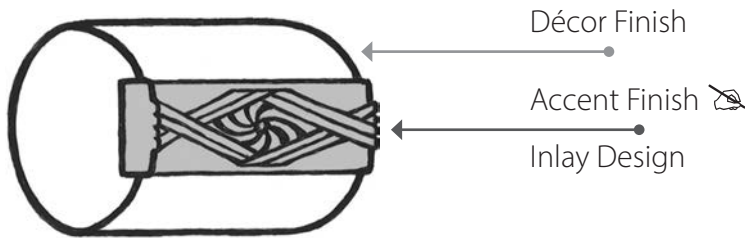

Select one of our **58 Décor Finishes** or our **Dual Finish System with 11 Accent Finishes**

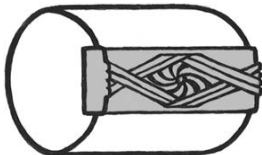
Inlay Pole		 <p>p. 52</p>							
Finish Group	Unit	2 Feet	4 Feet	6 Feet	8 Feet	10 Feet	12 Feet	14 Feet	16 Feet
<b>DIN-225 - Inlay Pole: 2¼" Diameter</b>									
A	EACH	\$144	\$288	\$432	\$576	\$720	\$864	\$1,008	\$1,152
B	EACH	\$150	\$300	\$450	\$600	\$750	\$900	\$1,050	\$1,200
C	EACH	\$168	\$336	\$504	\$672	\$840	\$1,008	\$1,176	\$1,344
<b>DIN-300 - Inlay Pole: 3" Diameter</b>									
A	EACH	\$160	\$320	\$480	\$640	\$800	\$960	\$1,120	\$1,280
B	EACH	\$168	\$336	\$504	\$672	\$840	\$1,008	\$1,176	\$1,344
C	EACH	\$186	\$372	\$558	\$744	\$930	\$1,116	\$1,302	\$1,488

# INLAY Designs: Matching Finials

Finials for 2¼" diameter poles; with Adaptor (included in Finial price) for 3" diameter poles.

- These 10 Finials each match one or our 10 Inlay or Decal designs. (But any Finial, Rod-End, SwissCrystal or Bohemia Crystal that fits a 2¼" or 3" diameter pole may be used with Inlay poles.)
- Finials come complete with screws for installing into wood.
- Orion wood poles are pre-drilled. Just screw the finial into the wood pole, and you are set for installation.

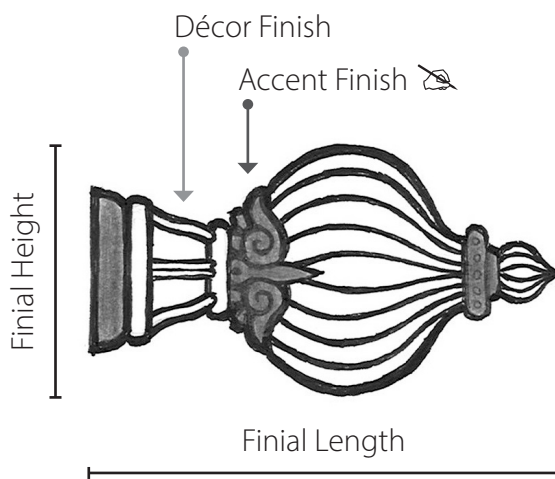

Select one of our **58 Décor Finishes** or our **Dual Finish System with 11 Accent Finishes**

**Autumn Finial**



p. 42

For 2¼" Poles  
**DF500-2**  
7⅛" L x 3¾" H

For 3" Poles  
**DF500-3**  
7¾" L x 3¾" H

Finish Group

A	B	C
\$66	\$88	\$108

**Cameo Finial**



p. 43

For 2¼" Poles  
**DF504-2**  
6¾" L x 3½" H

For 3" Poles  
**DF504-3**  
7⅜" L x 3½" H

Finish Group

A	B	C
\$70	\$90	\$112

**Garland Finial**



p. 44

For 2¼" Poles  
**DF509-2**  
6¾" L x 3¾" H



For 3" Poles  
**DF509-3**  
7⅜" L x 3¾" H





Finish Group

A	B	C
\$68	\$94	\$112

# INLAY Designs: Matching Finials

Finials for 2¼" diameter poles; with Adaptor (included in Finial price) for 3" diameter poles.

Harvest Finial			Opera Finial			Ornament Finial		
 p. 45			 p. 46			 p. 47		
For 2¼" Poles <b>DF513-2</b> 6½"L x 3¾"H			For 2¼" Poles <b>DF516-2</b> 6½"L x 3¼"H			For 2¼" Poles <b>DF520-2</b> 6¼"L x 3¾"H		
For 3" Poles <b>DF513-3</b> 7¼"L x 3¾"H			For 3" Poles <b>DF516-3</b> 7½"L x 3¼"H			For 3" Poles <b>DF520-3</b> 6⅞"L x 3¾"H		
Finish Group			Finish Group			Finish Group		
A	B	C	A	B	C	A	B	C
\$72	\$94	\$114	\$76	\$98	\$118	\$72	\$94	\$114



Paisley Finial			Pinwheel Finial			Scroll Finial			Sonnet Finial		
 p. 48			 p. 49			 p. 50			 p. 51		
For 2¼" Poles <b>DF522-2</b> 6¾"L x 3¾"H			For 2¼" Poles <b>DF524-2</b> 6¾"L x 3¾"H			For 2¼" Poles <b>DF530-2</b> 7"L x 4"H			For 2¼" Poles <b>DF527-2</b> 7"L x 3¾"H		
For 3" Poles <b>DF522-3</b> 7⅜"L x 3¾"H			For 3" Poles <b>DF524-3</b> 7⅜"L x 3¾"H			For 3" Poles <b>DF530-3</b> 7⅝"L x 4"H			For 3" Poles <b>DF527-3</b> 7⅝"L x 3¾"H		
Finish Group			Finish Group			Finish Group			Finish Group		
A	B	C	A	B	C	A	B	C	A	B	C
\$74	\$96	\$116	\$74	\$96	\$116	\$76	\$98	\$118	\$76	\$98	\$118

# INLAY Designs: Decals

Decal styles for Insignia Finials, Emblem Finials, Inlay Bases and Decal Brackets.

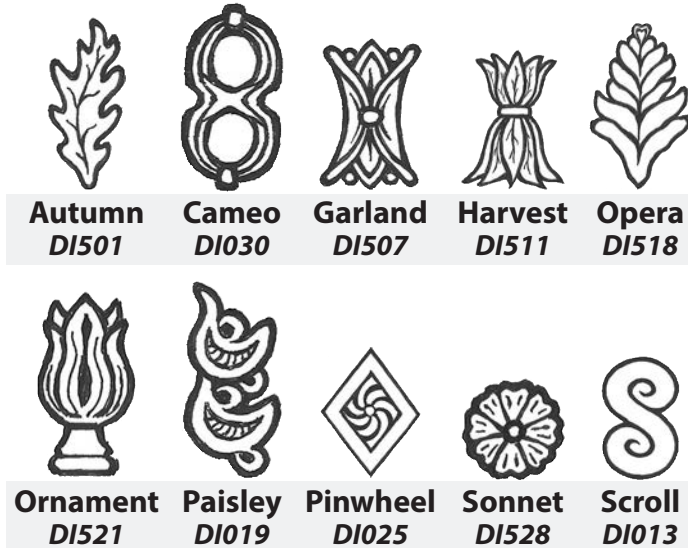
- Inlay Decals are small decorative emblems, designed to match each of the 10 Inlay designs.
- Decals can only be placed on Insignia Finials, Emblem Finials, Inlay Bases and Decal Brackets.
- When ordering, please include the Decal number along with the item number.



Insignia Finial			Emblem Finial		
 <p>p. 41-43</p>			 <p>p. 41, 49</p>		
For 2¼" Poles <b>DF634X-2</b> 6⅞" L x 4" H			For 2¼" Poles <b>DF633X-2</b> 6¾" L x 4¼" H		
For 3" Poles <b>DF634X-3</b> 7½" L x 4" H			For 3" Poles <b>DF633X-3</b> 7⅜" L x 4¼" H		
Also available for 2" Poles			Also available for 2" Poles		
Finish Group			Finish Group		
A	B	C	A	B	C
\$84	\$106	\$134	\$124	\$140	\$180

Select one of our **58 Décor Finishes** or our **Dual Finish System with 11 Accent Finishes** 

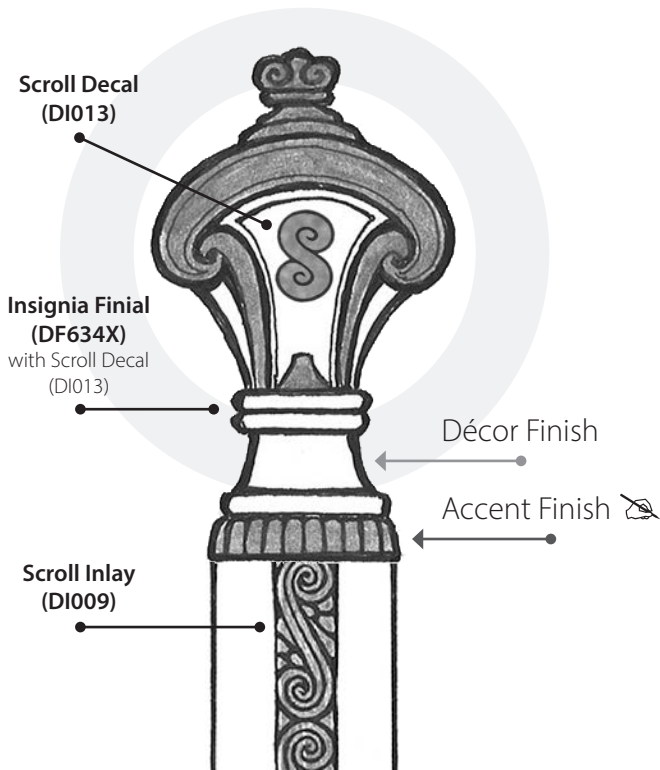

Inlay Base		
 <p>p. 41, 42, 44, 45, 49 - 51</p>		
For 2¼" Poles <b>DY635X-2</b> 3⅝" L x 2⅞" H		For 3" Poles <b>DY635X-3</b> 4¼" L x 3⅜" H
Flush Mount Use: Yes		
For use with all SwissCrystal Finials. See price list pages 23-24. Also available for 2" Poles		
Finish Group		
A	B	C
\$116	\$120	\$150

# INLAY Designs: Brackets

Brackets for use with Inlay or Decals.

When ordering, please include the Inlay design number from page 40 or the Decal number from page 44 along with the item number.

## Inlay Bracket

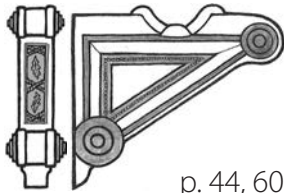

p. 44, 60

Please include the Inlay design number from price list page 40 along with the bracket number.

For 2 1/4" Poles  
**DB555X-5P-225**

9 1/4" L x 8 1/4" H  
3 1/2" THICK; 4 7/8" PROJECTION

*Includes Adaptor Cradle  
for 2" or 2 1/4" Poles*

### Finish Group

A	B	C
\$186	\$196	\$218

## Inlay Bracket

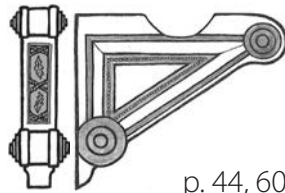

p. 44, 60

Please include the Inlay design number from price list page 40 along with the bracket number.

For 3" Poles  
**DB555X-5P-300**

9 1/4" L x 8 1/4" H  
3 1/2" THICK; 4 7/8" PROJECTION

### Finish Group

A	B	C
\$186	\$196	\$218

## Decal Bracket\*

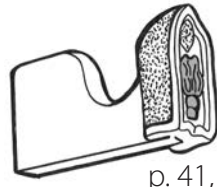

p. 41, 59

Please include the Decal design number from price list page 44 along with the bracket number.

For 2 1/4" Poles  
**DB605X-4P-225**

6 3/4" L x 4 3/8" H  
2 1/4" THICK; 1" THICK AT WALL;  
4" PROJECTION

### Finish Group

A	B	C
\$130	\$144	\$160

For 3" Poles  
**DB605X-4P-300**

6 3/4" L x 4 3/8" H  
2 1/4" THICK; 1" THICK AT WALL;  
4 1/4" PROJECTION

### Finish Group

A	B	C
\$136	\$150	\$166

## Decal Bracket\*

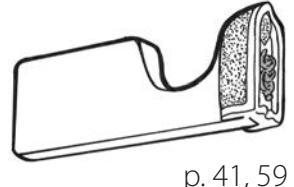

p. 41, 59

Please include the Decal design number from price list page 44 along with the bracket number.

For 2 1/4" Poles  
**DB605X-7P-225**

10" L x 4 3/8" H  
2 1/4" THICK; 1" THICK AT WALL;  
7" PROJECTION

### Finish Group

A	B	C
\$150	\$166	\$180

For 3" Poles  
**DB605X-8P-300**

10" L x 4 3/8" H  
2 1/4" THICK; 1" THICK AT WALL;  
7 1/2" PROJECTION

### Finish Group

A	B	C
\$166	\$184	\$190

\*Indicates bracket has small back plate for use in tight spaces.

# WOOD Poles, Traversing & Motorization



# WOOD Poles, Traversing & Motorization

## DETAILS

- Wood poles are available in four sizes and four styles: 1 $\frac{3}{8}$ " 2", 2 $\frac{1}{4}$ " or 3"; Smooth, Fluted, Rope or Inlay.
- All are available in any of our 58 Décor Finishes.  
Only Inlay poles are available in our Dual Finish System with 11 Accent Finishes .
- The maximum continuous length for a wood pole is 16' (192"), but any length can be achieved by splicing poles together (we splice any wood pole over 8'10" (106") to save on shipping charges).
- Manual or motorized traversing poles are available in diameters 2" and above, and up to 30 feet in length.
- All wood poles can be mitered.

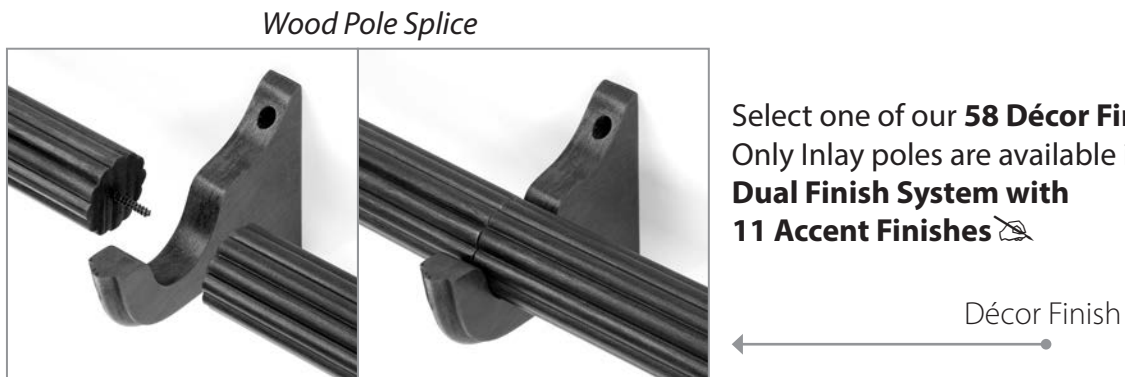

**Design Art offers two types of cuts to join your poles together.**



Our standard Wood Pole Splice joins two poles with a metal screw connector (included) and will be used unless a Miter Splice is specified. **A bracket should be used underneath any pole splice. It conceals the splice while offering additional support.**

Our Miter Splice breaks up the visual line of the connection, obscuring the splice better than a straight cut, and is at a 45° angle. It can also be used to join poles in corners or special applications like bay windows. Our standard cuts are for 45° or 90° angle connections. Wood glue is needed for a Miter Splice, and must be supplied by the installer. **A bracket should be used underneath any pole splice for additional support.** Please call customer service for a quote on angles other than for 45° or 90°.

When ordering complete drapery hardware sets and accessories don't forget to include:

- Finials (pages 12-15)
- Rod-Enders (pages 18-19)
- Crystal and Bases (pages 23-29 and 36-37)
- Brackets (pages 74-77 and 83-85)
- Rings (pages 80-82)
- Batons\* (page 79)
- Holdbacks\* (page 86)
- Centerpieces (page 87)

\* optional



## SHIPPING & INSTALLATION NOTES



Orion wood poles are pre-drilled. Just screw the finial into the wood pole, and you are set for installation.

# WOOD Poles

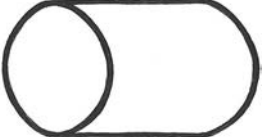
1<sup>3</sup>/<sub>8</sub>" , 2" , 2<sup>1</sup>/<sub>4</sub>" and 3" Diameter Poles

• The maximum continuous length for a wood pole is 16' (192"). We splice any wood pole with a Wood Pole Splice (DM5054) over 8'10" (106") to save on shipping charges using FedEx. (New FedEx surcharge, above 96" in length per box will be added in addition to the shipping and handling charges.) Poles not specified as one piece in the order will be spliced in the center, unless splice location is otherwise noted. Anything over 8'10" (106") must be shipped by common carrier (truck line). Please contact customer service for details as delivery restrictions apply.

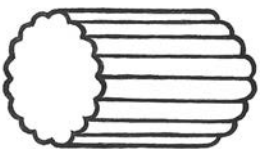
Finish Group	Unit	2 Feet	4 Feet	6 Feet	8 Feet	10 Feet	12 Feet	14 Feet	16 Feet
<div style="display: flex; align-items: center; justify-content: space-between;"> <div style="text-align: center;">  <p><b>Smooth Pole</b></p> <p>p. 52</p> </div> <div style="text-align: center;">  <p>Available for Quick Ship. See pages 6-9.</p> </div> </div>									
<b>DSM-138 - Smooth Pole: 1<sup>3</sup>/<sub>8</sub>" Diameter</b>									
A	EACH	\$44	\$88	\$132	\$176	\$220	\$264	\$308	\$352
B	EACH	\$46	\$92	\$138	\$184	\$230	\$276	\$322	\$368
<b>DSM-200 - Smooth Pole: 2" Diameter</b>									
A	EACH	\$56	\$112	\$168	\$224	\$280	\$336	\$392	\$448
B	EACH	\$58	\$116	\$174	\$232	\$290	\$348	\$406	\$464
<b>DSM-225 - Smooth Pole: 2<sup>1</sup>/<sub>4</sub>" Diameter</b>									
A	EACH	\$56	\$112	\$168	\$224	\$280	\$336	\$392	\$448
B	EACH	\$58	\$116	\$174	\$232	\$290	\$348	\$406	\$464
<b>DSM-300 - Smooth Pole: 3" Diameter</b>									
A	EACH	\$106	\$212	\$318	\$424	\$530	\$636	\$742	\$848
B	EACH	\$110	\$220	\$330	\$440	\$550	\$660	\$770	\$880

Finish Group	Unit	2 Feet	4 Feet	6 Feet	8 Feet	10 Feet	12 Feet	14 Feet	16 Feet
<div style="display: flex; align-items: center; justify-content: space-between;"> <div style="text-align: center;">  <p><b>Fluted Pole</b></p> <p>p. 52</p> </div> <div style="text-align: center;">  <p>Available for Quick Ship. See pages 6-9.</p> </div> </div>									
<b>DFL-138 - Fluted Pole: 1<sup>3</sup>/<sub>8</sub>" Diameter</b>									
A	EACH	\$44	\$88	\$132	\$176	\$220	\$264	\$308	\$352
B	EACH	\$46	\$92	\$138	\$184	\$230	\$276	\$322	\$368
<b>DFL-200 - Fluted Pole: 2" Diameter</b>									
A	EACH	\$56	\$112	\$168	\$224	\$280	\$336	\$392	\$448
B	EACH	\$58	\$116	\$174	\$232	\$290	\$348	\$406	\$464
<b>DFL-225 - Fluted Pole: 2<sup>1</sup>/<sub>4</sub>" Diameter</b>									
A	EACH	\$56	\$112	\$168	\$224	\$280	\$336	\$392	\$448
B	EACH	\$58	\$116	\$174	\$232	\$290	\$348	\$406	\$464
<b>DFL-300 - Fluted Pole: 3" Diameter</b>									
A	EACH	\$106	\$212	\$318	\$424	\$530	\$636	\$742	\$848
B	EACH	\$110	\$220	\$330	\$440	\$550	\$660	\$770	\$880



# WOOD Poles

1<sup>3</sup>/<sub>8</sub>" , 2" , 2<sup>1</sup>/<sub>4</sub>" and 3" Diameter Poles

- As a general guideline, we recommend brackets every 4 feet.
- Poles can be spliced together to provide any length using a Wood Pole Splice (Standard, Product DM5054) or Miter Splice (Please specify Product DM5055).
- Wood poles are available and priced in sections of 2', 4', 6', 8', 10', 12', 14' and 16'.
- Manual or motorized traversing poles are available up to 30' (360") in length (see pages 54-69).
- Unfinished products are available by quote only.

Rope Pole		 p. 52							
Finish Group	Unit	2 Feet	4 Feet	6 Feet	8 Feet	10 Feet	12 Feet	14 Feet	16 Feet
<b>DRP-138 - Rope Pole: 1<sup>3</sup>/<sub>8</sub>" Diameter</b>									
A	EACH	\$76	\$152	\$228	\$304	\$380	\$456	\$532	\$608
B	EACH	\$80	\$160	\$240	\$320	\$400	\$480	\$560	\$640
<b>DRP-200 - Rope Pole: 2" Diameter</b>									
A	EACH	\$108	\$216	\$324	\$432	\$540	\$648	\$756	\$864
B	EACH	\$114	\$228	\$342	\$456	\$570	\$684	\$798	\$912
<b>DRP-225 - Rope Pole: 2<sup>1</sup>/<sub>4</sub>" Diameter</b>									
A	EACH	\$108	\$216	\$324	\$432	\$540	\$648	\$756	\$864
B	EACH	\$114	\$228	\$342	\$456	\$570	\$684	\$798	\$912
<b>DRP-300 - Rope Pole: 3" Diameter</b>									
A	EACH	\$144	\$288	\$432	\$576	\$720	\$864	\$1,008	\$1,152
B	EACH	\$150	\$300	\$450	\$600	\$750	\$900	\$1,050	\$1,200

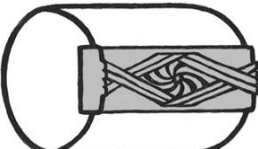
Inlay Pole		 p. 52							
Finish Group	Unit	2 Feet	4 Feet	6 Feet	8 Feet	10 Feet	12 Feet	14 Feet	16 Feet
When ordering, please include the Inlay design number from price list page 40 along with the pole number.									
<b>DIN-225 - Inlay Pole: 2<sup>1</sup>/<sub>4</sub>" Diameter</b>									
A	EACH	\$144	\$288	\$432	\$576	\$720	\$864	\$1,008	\$1,152
B	EACH	\$150	\$300	\$450	\$600	\$750	\$900	\$1,050	\$1,200
C	EACH	\$168	\$336	\$504	\$672	\$840	\$1,008	\$1,176	\$1,344
<b>DIN-300 - Inlay Pole: 3" Diameter</b>									
A	EACH	\$160	\$320	\$480	\$640	\$800	\$960	\$1,120	\$1,280
B	EACH	\$168	\$336	\$504	\$672	\$840	\$1,008	\$1,176	\$1,344
C	EACH	\$186	\$372	\$558	\$744	\$930	\$1,116	\$1,302	\$1,488

## Wood Pole Splice

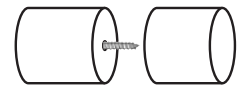

For All Poles  
**DM5054**

Includes metal screw connector. Please note, every splice should be reinforced with a bracket.

**No Charge**

## Miter Splice



For All Poles  
**DM5055**

For splices and corners like bay windows. Standard 45° or 90° angle connections. Contact customer service for any other custom angle. Wood glue is needed for a Miter Splice, and must be supplied by the installer. Please note, every splice should be reinforced with a bracket.

**Price Each**      \$12

## Miter Return

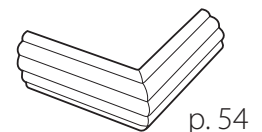

For All Poles  
**307MR**

Please specify return depth in your order. Standard return depths are 3<sup>1</sup>/<sub>2</sub>", 4<sup>1</sup>/<sub>2</sub>", 6", and 7" for single poles, 9<sup>1</sup>/<sub>2</sub>" for double poles.

**Price Each**      \$54

# TRAVERSING GUIDE: Glides

## Manual or Motorized Traversing Measurements Using Pinch Pleat Glides

- A. Distance from top of ring to bottom of glide.
- B. Distance from top of ring to pole.
- C. Distance from top of pole to bottom of glide.
- D. Distance from bottom of ring to bottom of glide. (Same for all:  $\frac{3}{8}$ "
- E. Distance from bottom of pole to bottom of glide. (Same for all:  $1\frac{3}{8}$ "

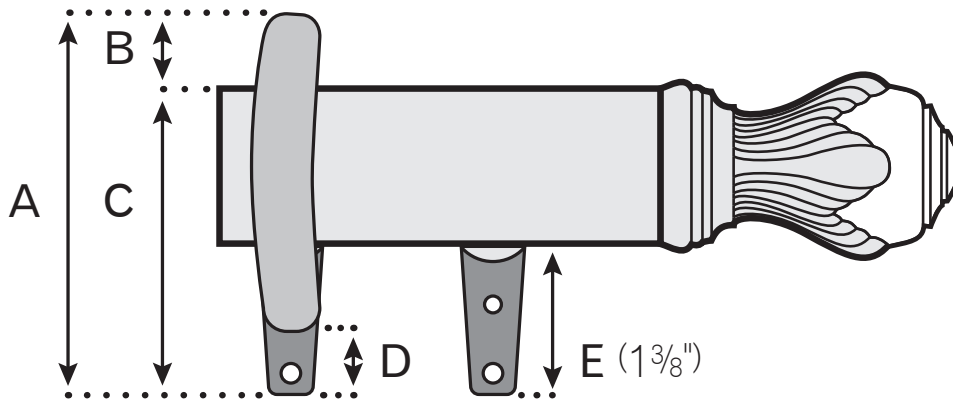

2" Diameter Poles		2¼" Diameter Poles		3" Diameter Poles	
A.	4"	A.	4¼"	A.	5 <sup>5</sup> / <sub>8</sub> "
B.	<sup>3</sup> / <sub>4</sub> "	B.	<sup>7</sup> / <sub>8</sub> "	B.	1"
C.	3¼"	C.	3 <sup>3</sup> / <sub>8</sub> "	C.	4 <sup>3</sup> / <sub>8</sub> "

## Manual or Motorized Traversing Measurements Using RippleFold Glides

- A. Distance from top of pole to bottom of glide.
- B. Distance from bottom of pole to bottom of glide.  
Manual Traversing:  $\frac{3}{4}$ " Motorized Traversing:  $\frac{15}{16}$ "
- C. Inner diameter of RippleFold carrier. (Same for all:  $\frac{1}{4}$ "

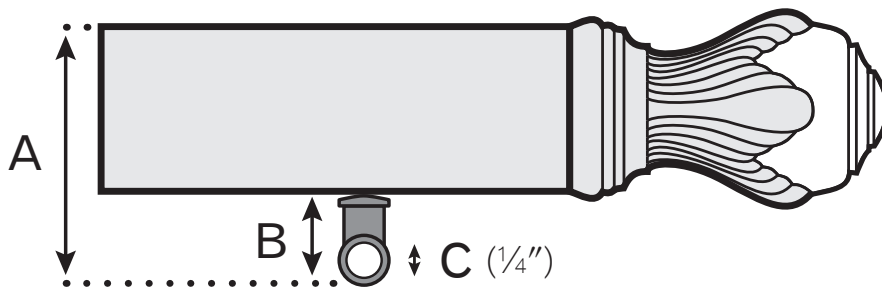

2" Diameter Poles		2¼" Diameter Poles		3" Diameter Poles		
Manual	Motorized	Manual	Motorized	Manual	Motorized	
A.	2 <sup>3</sup> / <sub>4</sub> "	A.	2 <sup>15</sup> / <sub>16</sub> "	A.	3 <sup>3</sup> / <sub>4</sub> "	
					A.	3 <sup>15</sup> / <sub>16</sub> "

# TRAVERSING GUIDE: Tracks

## Manual and Motorized Traversing Track Measurements

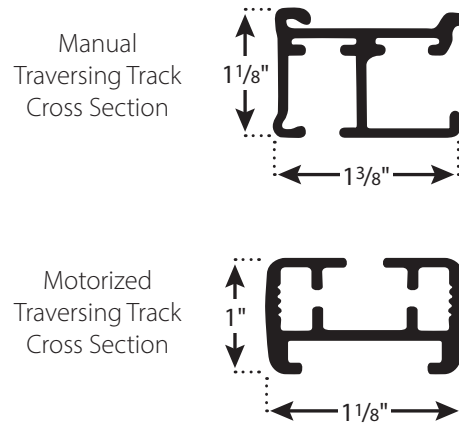

## Manual Traversing Splice Plate

- Untighten all four screws on the splice plate to allow the top of each track to slide under a locking plate. Tracks are shown upside down. The splice plate will be on top of the tracks once installed.
- Connect tracks together in the center of the plate. Do not leave any space between the tracks. Retighten splice plate screws.

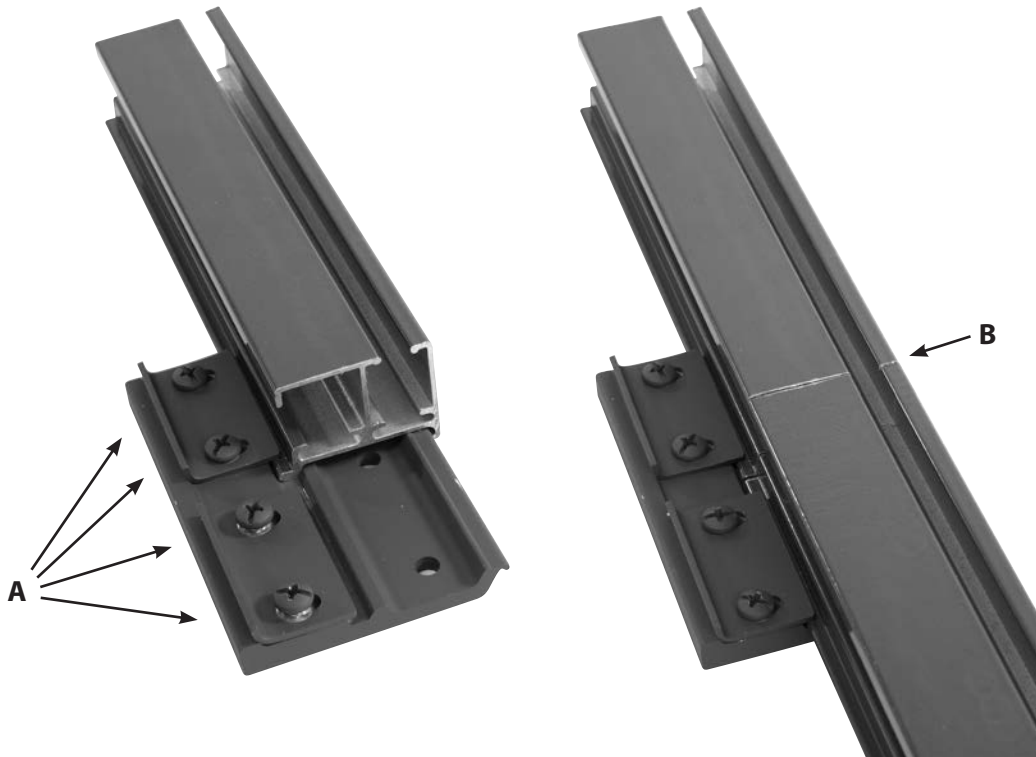

# TRAVERSING GUIDE: Manual Installation

1. Unwrap and check all parts.  
Parts will vary by order.

When ordering with rings, two stationary rings (A) are placed on each end for center open systems, one ring is placed on the stack side for one-way draw systems.

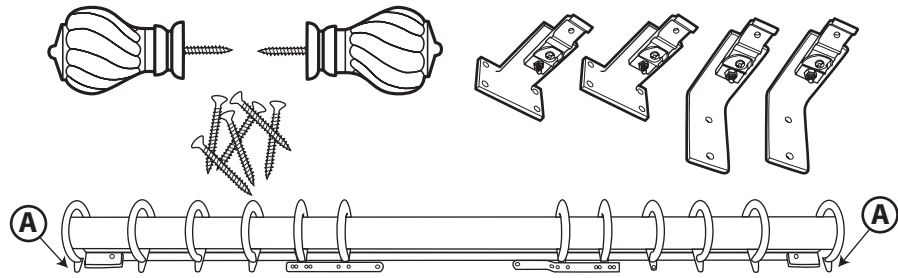

2. Manual traversing hardware should be installed in wall studs where possible. We suggest using a density analyzer to determine stud locations.

- (a) If installing in wall without stud, use heavy duty hollow wall anchors (e.g., Hillman #370012) or toggle bolts. We recommend ordering extra center supports when hollow wall anchors are being used.
- (b) Make sure support brackets do not line up with fascia screws (B).
- (c) Use level to make sure all brackets are on the same horizontal plane.

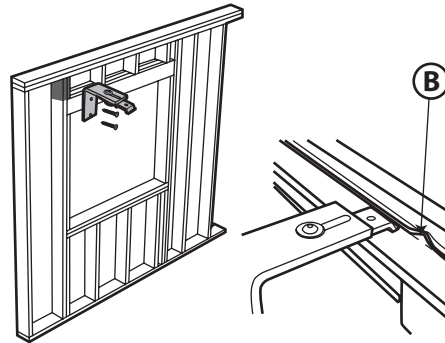

3. Adjust projection of bracket clip by loosening the screw nut (C). Adjust bracket projection as needed. Retighten the screw nut to hold the clip in desired position.

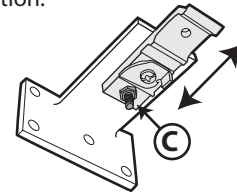

4. Screw finials into the pre-drilled holes on the wood pole.

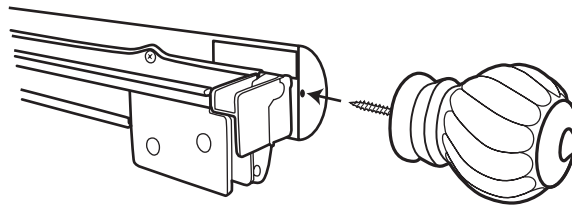

5. Clip traversing track onto the brackets on the wall; make sure track is securely in brackets. Turn bracket clips (D) to lock brackets with the track.

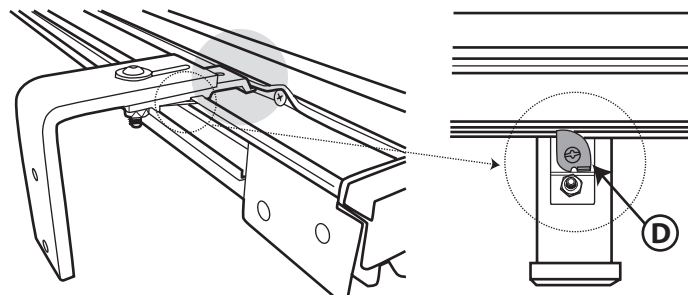

6. Test the cord to assure that rod draws smoothly. Install the floor tension pulley for the cord.

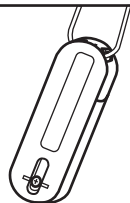

7. If installing without rings, please hang drapery from the top hole of the glide (E).

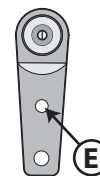

We recommend using a professional installer. While installation hardware is included, it may not be appropriate for your specific wall material or individual installation. The Company will not assume any responsibility for damages incurred by inadequately supported or improperly mounted hardware.

# TRAVERSING GUIDE: Motorized Installation

1. Unwrap and check all parts.  
Parts will vary by order.

When ordering with rings, two stationary rings (A) are placed on each end for center open systems, one ring is placed on the stack side for one-way draw systems.

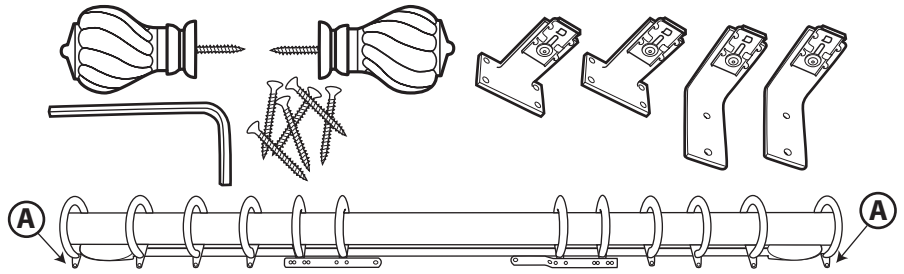

2. Motorized traversing hardware should be installed in wall studs where possible. We suggest using a density analyzer to determine stud locations.

- (a) If installing in wall without stud, use heavy duty hollow wall anchors (e.g., Hillman #370012) or toggle bolts. We recommend ordering extra center supports when hollow wall anchors are being used.
- (b) Make sure support brackets do not line up with fascia attachments (B).
- (c) Use level to make sure all brackets are on the same horizontal plane.

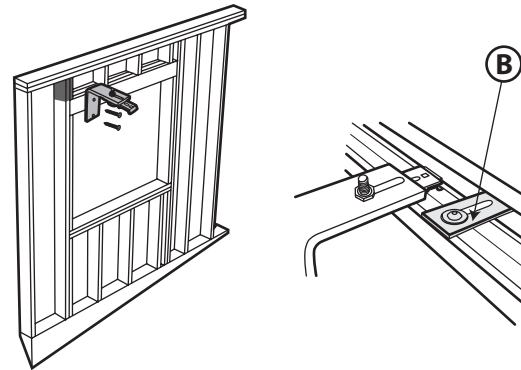

3. Adjust projection of bracket clip by loosening the screw nut (C). Adjust bracket projection as needed. Retighten the screw nut to hold the clip in desired position.

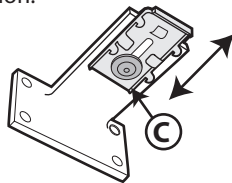

4. Screw finials into the pre-drilled holes on the wood pole.

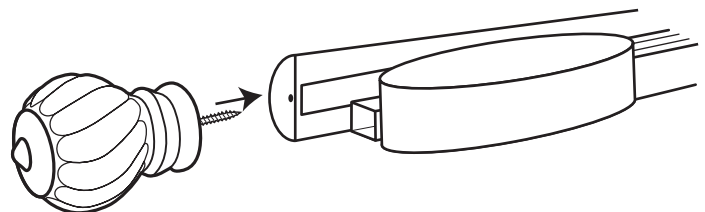

5. Clip traversing track onto the brackets on the wall; make sure track is securely in brackets.

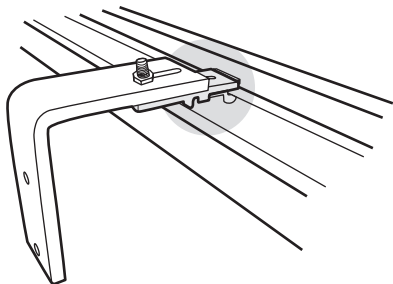

6. Install Somfy motor.  
Slide finished sleeve (D) up to base of track.  
Plug in Somfy motor.

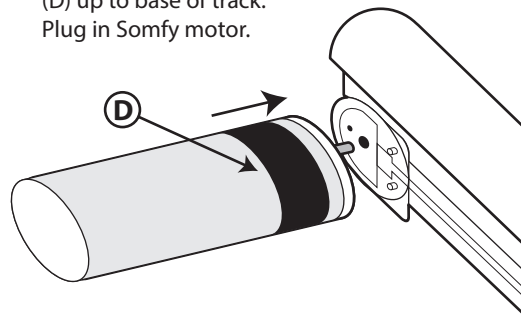

7. If installing without rings, please hang drapery from the top hole of the glide (E).

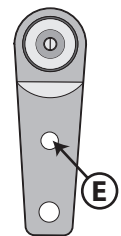

We recommend using a professional installer. While installation hardware is included, it may not be appropriate for your specific wall material or individual installation. The Company will not assume any responsibility for damages incurred by inadequately supported or improperly mounted hardware.

# MANUAL Traversing Poles

2", 2¼" and 3" Diameter Manual Traversing Poles

## Pole Styles

Front Poles:

- Smooth, Fluted or Rope: 2", 2¼" and 3" Diameters
- Inlay: 2¼" and 3" Diameters

Back Poles (For Double):

- With Smooth, Fluted, or Rope Front: Matching 1⅜" Poles
- With Inlay Front: 1⅜" Smooth Pole

*Finished End Caps are included on all back rods.*

Miter Return Available (307MR)

## Finishes

For Front & Back Poles in Smooth, Fluted or Rope:  
58 Décor Finishes, plus Custom Colors

For Front Inlay Poles Only:

58 Décor Finishes, Dual Finish System with  
11 Accent Finishes , plus Custom Colors  
*Custom Colors are additional charge.*

*Please contact customer service for a quote.*

## Sets Include

- Traversing Pole(s) Up to 30 Feet in Length
- Heavy Duty Track(s) in Antique Bronze, Black, Gold, Silver, & White  
Maximum fabric weight for a 16' track is 62 pounds.
- Pinch Pleat or RippleFold Glides:  
Colored pinch pleat glides for systems with rings coordinate with track finishes (standard 4 per foot).  
Pinch pleat glides for systems without rings and RippleFold glides are white. RippleFold glides include snap tape.  
*Please state fullness of 60%, 80%, 100%, or 120% when ordering RippleFold.*
- Finished Master Carriers:  
Center open poles come with two master carriers, while one-way draw poles come with one.  
Front pole carriers each hold two rings (pinch pleat glides only).  
Pinch pleat available with one-way or overlap master carriers.  
RippleFold available with one-way, overlap or butt master carriers.
- Cord, Cord Pulleys & Safety Pulley(s)  
Cord drawn traversing sets include cords and cord pulleys. Batons for baton drawn sets are sold separately.  
Include cord length (standard is 8'), cord placement (left or right), and draw (left stack, right stack, or center open) in your order.
- Drapery Return Hook(s)
- Finished Brackets:
  - Two Heavy Duty End Brackets with Expandable Projections
  - Heavy Duty Support Brackets with Expandable Projections as Needed per Length  
*Specify wall or ceiling mount brackets when ordering. Due to limited clearance, we recommend using Rod-Enders with ceiling mount brackets. Please contact customer service for a list of other finials which may be used, or to create a bracket with a custom drop.*
- Finished End Caps (For Back Rods)

## Items Sold Separately

- Finials (pages 12-15), Rod-Enders (pages 18-19),  
Crystal and Bases (pages 23-29 and 36-37)
- Miter Return (307MR) (page 61)  
Standard Return Depths are 3½", 4½", 6", and 7" for  
single track systems, 9½" for double track systems.
- Batons (page 60)
- Rings Styles For:
  - Traversing Poles (page 61)
  - Stationery Front Poles (pages 80-82)  
*Rings are available on front poles only using pinch  
pleat glides. Two stationary rings are placed on each  
end of the pole for center open systems, one ring is  
placed on the stack side for one-way draw systems.  
Front pole master carriers each hold two rings.*

## Splices and Shipping

- All traversing sets are available in 16' (192") lengths  
without a splice, and up to 30' (360") with a splice.
- We splice any center open traversing pole over 8'6" (102")  
to save on shipping charges using FedEx. (*New FedEx  
surcharge, above 96" in length per box will be added in  
addition to the shipping and handling charges.*) (One-way  
draw is not spliced for FedEx.) Traversing systems not  
specified as one piece will be spliced in the center, unless a  
splice location is otherwise noted.
- The maximum width for a FedEx shipment is 8' 6"  
(102"). All sets over this must be shipped by common  
carrier (truck line). Please note residential truck deliveries  
are restricted to 24' (288").

## Measurement Guidelines

- Please specify fascia length when ordering.
- Usable track length will be 2¼" shorter than fascia length. (L - 2¼")

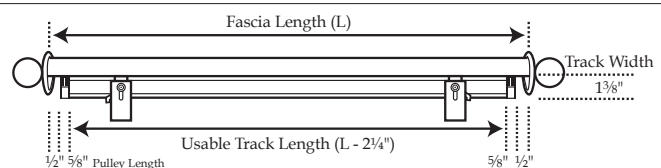

# MANUAL Traversing Poles: Single

2", 2¼" and 3" Diameter Single Manual Traversing Poles

*Traversing set pricing is rounded up to the next foot.*

## Single Smooth Manual Traversing Pole

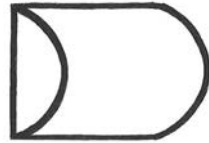

p. 53

Style	Set #	4 Feet	5 Feet	6 Feet	7 Feet	8 Feet	9 Feet	10 Feet	Additional Foot
Smooth 2" Dia.	<b>DTSM-S-200</b>	\$376	\$470	\$564	\$658	\$752	\$846	\$940	\$94
Smooth 2¼" Dia.	<b>DTSM-S-225</b>	\$376	\$470	\$564	\$658	\$752	\$846	\$940	\$94
Smooth 3" Dia.	<b>DTSM-S-300</b>	\$416	\$520	\$624	\$728	\$832	\$936	\$1,040	\$104

## Single Fluted Manual Traversing Pole

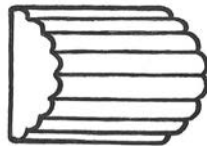

p. 53

Style	Set #	4 Feet	5 Feet	6 Feet	7 Feet	8 Feet	9 Feet	10 Feet	Additional Foot
Fluted 2" Dia.	<b>DTFL-S-200</b>	\$376	\$470	\$564	\$658	\$752	\$846	\$940	\$94
Fluted 2¼" Dia.	<b>DTFL-S-225</b>	\$376	\$470	\$564	\$658	\$752	\$846	\$940	\$94
Fluted 3" Dia.	<b>DTFL-S-300</b>	\$416	\$520	\$624	\$728	\$832	\$936	\$1,040	\$104

## Single Rope Manual Traversing Pole

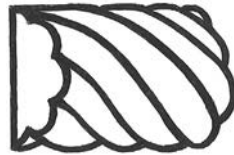

p. 53

Style	Set #	4 Feet	5 Feet	6 Feet	7 Feet	8 Feet	9 Feet	10 Feet	Additional Foot
Rope 2" Dia.	<b>DTRP-S-200</b>	\$448	\$560	\$672	\$784	\$896	\$1,008	\$1,120	\$112
Rope 2¼" Dia.	<b>DTRP-S-225</b>	\$448	\$560	\$672	\$784	\$896	\$1,008	\$1,120	\$112
Rope 3" Dia.	<b>DTRP-S-300</b>	\$512	\$640	\$768	\$896	\$1,024	\$1,152	\$1,280	\$128

## Single Inlay Manual Traversing Pole

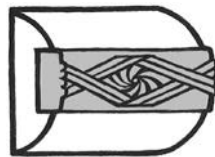

p. 53

When ordering, please include the Inlay design number from price list page 40 along with the pole number.

Style	Set #	4 Feet	5 Feet	6 Feet	7 Feet	8 Feet	9 Feet	10 Feet	Additional Foot
Inlay 2¼" Dia.	<b>DTIN-S-225</b>	\$448	\$560	\$672	\$784	\$896	\$1,008	\$1,120	\$112
Inlay 3" Dia.	<b>DTIN-S-300</b>	\$512	\$640	\$768	\$896	\$1,024	\$1,152	\$1,280	\$128

### Splice and Bracket Guide for Single or Double Manual Traversing Sets

Length	Inches	36"-48"	48½"-84"	84½"-120"	120½"-156"	156½"-192"	192½"-228"	228½"-264"	264½"-300"	300½"-336"	336½"-360"
	Feet	3'-4'	4'-7'	7'-10'	10'-13'	13'-16'	16'-19'	19'-22'	22'-25'	25'-28'	28'-30'
Splices*		0	0	0	0	0	1	1	1	1	1
Brackets		2	3	4	5	6	7	8	9	10	11

\*Please see "Splices and Shipping" on page 54. Bracket numbers given here are a guide.

# MANUAL Traversing Poles: Double

2", 2¼" and 3" Diameter Double Manual Traversing Poles

*Traversing set pricing is rounded up to the next foot. Back pole is 1½" diameter.*

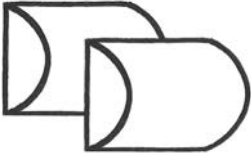
<b>Double Smooth Manual Traversing Poles</b>									
		p. 53							
Style	Set #	4 Feet	5 Feet	6 Feet	7 Feet	8 Feet	9 Feet	10 Feet	Additional Foot
Smooth 2" Dia.	<b>DTSM-D-200</b>	\$740	\$925	\$1,110	\$1,295	\$1,480	\$1,665	\$1,850	\$185
Smooth 2¼" Dia.	<b>DTSM-D-225</b>	\$740	\$925	\$1,110	\$1,295	\$1,480	\$1,665	\$1,850	\$185
Smooth 3" Dia.	<b>DTSM-D-300</b>	\$872	\$1,090	\$1,308	\$1,526	\$1,744	\$1,962	\$2,180	\$218

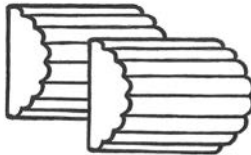
<b>Double Fluted Manual Traversing Poles</b>									
		p. 53							
Style	Set #	4 Feet	5 Feet	6 Feet	7 Feet	8 Feet	9 Feet	10 Feet	Additional Foot
Fluted 2" Dia.	<b>DTFL-D-200</b>	\$740	\$925	\$1,110	\$1,295	\$1,480	\$1,665	\$1,850	\$185
Fluted 2¼" Dia.	<b>DTFL-D-225</b>	\$740	\$925	\$1,110	\$1,295	\$1,480	\$1,665	\$1,850	\$185
Fluted 3" Dia.	<b>DTFL-D-300</b>	\$872	\$1,090	\$1,308	\$1,526	\$1,744	\$1,962	\$2,180	\$218

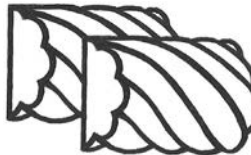
<b>Double Rope Manual Traversing Poles</b>									
		p. 53							
Style	Set #	4 Feet	5 Feet	6 Feet	7 Feet	8 Feet	9 Feet	10 Feet	Additional Foot
Rope 2" Dia.	<b>DTRP-D-200</b>	\$872	\$1,090	\$1,308	\$1,526	\$1,744	\$1,962	\$2,180	\$218
Rope 2¼" Dia.	<b>DTRP-D-225</b>	\$872	\$1,090	\$1,308	\$1,526	\$1,744	\$1,962	\$2,180	\$218
Rope 3" Dia.	<b>DTRP-D-300</b>	\$1,104	\$1,380	\$1,656	\$1,932	\$2,208	\$2,484	\$2,760	\$276

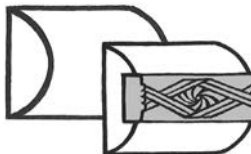
<b>Double with Inlay: Inlay Front, Smooth Back Manual Traversing Poles</b>									
		p. 53							
Style	Set #	4 Feet	5 Feet	6 Feet	7 Feet	8 Feet	9 Feet	10 Feet	Additional Foot
Inlay 2¼" Dia.	<b>DTIN-D-225</b>	\$872	\$1,090	\$1,308	\$1,526	\$1,744	\$1,962	\$2,180	\$218
Inlay 3" Dia.	<b>DTIN-D-300</b>	\$1,104	\$1,380	\$1,656	\$1,932	\$2,208	\$2,484	\$2,760	\$276

When ordering, please include the Inlay design number from price list page 40 along with the pole number.



# MANUAL Traversing Poles: Double

2", 2¼" and 3" Diameter Stationary Front, Manual Traversing Back Poles

*Traversing set pricing is rounded up to the next foot. Back pole is 1½" diameter.*

**Double Smooth:  
Stationary Front,  
Manual Traversing Back**

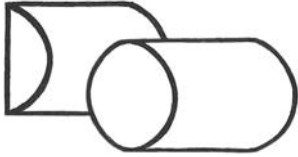

p. 53

Style	Set #	4 Feet	5 Feet	6 Feet	7 Feet	8 Feet	9 Feet	10 Feet	Additional Foot
Smooth 2" Dia.	<b>DRTSM-D-200</b>	\$496	\$620	\$744	\$868	\$992	\$1,116	\$1,240	\$124
Smooth 2¼" Dia.	<b>DRTSM-D-225</b>	\$496	\$620	\$744	\$868	\$992	\$1,116	\$1,240	\$124
Smooth 3" Dia.	<b>DRTSM-D-300</b>	\$600	\$750	\$900	\$1,050	\$1,200	\$1,350	\$1,500	\$150

**Double Fluted:  
Stationary Front,  
Manual Traversing Back**

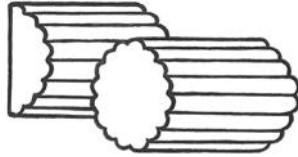

p. 53

Style	Set #	4 Feet	5 Feet	6 Feet	7 Feet	8 Feet	9 Feet	10 Feet	Additional Foot
Fluted 2" Dia.	<b>DRTFL-D-200</b>	\$496	\$620	\$744	\$868	\$992	\$1,116	\$1,240	\$124
Fluted 2¼" Dia.	<b>DRTFL-D-225</b>	\$496	\$620	\$744	\$868	\$992	\$1,116	\$1,240	\$124
Fluted 3" Dia.	<b>DRTFL-D-300</b>	\$600	\$750	\$900	\$1,050	\$1,200	\$1,350	\$1,500	\$150

**Double Rope:  
Stationary Front,  
Manual Traversing Back**



p. 53

Style	Set #	4 Feet	5 Feet	6 Feet	7 Feet	8 Feet	9 Feet	10 Feet	Additional Foot
Rope 2" Dia.	<b>DRTRP-D-200</b>	\$680	\$850	\$1,020	\$1,190	\$1,360	\$1,530	\$1,700	\$170
Rope 2¼" Dia.	<b>DRTRP-D-225</b>	\$680	\$850	\$1,020	\$1,190	\$1,360	\$1,530	\$1,700	\$170
Rope 3" Dia.	<b>DRTRP-D-300</b>	\$752	\$940	\$1,128	\$1,316	\$1,504	\$1,692	\$1,880	\$188

**Double with Inlay:  
Stationary Inlay Front,  
Smooth Manual  
Traversing Back**

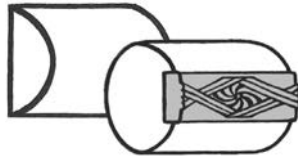

p. 53

When ordering, please include the Inlay design number from price list page 40 along with the pole number.

Style	Set #	4 Feet	5 Feet	6 Feet	7 Feet	8 Feet	9 Feet	10 Feet	Additional Foot
Inlay 2¼" Dia.	<b>DRTIN-D-225</b>	\$680	\$850	\$1,020	\$1,190	\$1,360	\$1,530	\$1,700	\$170
Inlay 3" Dia.	<b>DRTIN-D-300</b>	\$752	\$940	\$1,128	\$1,316	\$1,504	\$1,692	\$1,880	\$188

# MANUAL Traversing Poles: Brackets

Manual Traversing - Additional Brackets

Space between double traversing tracks is 3¼" - 6⅞".

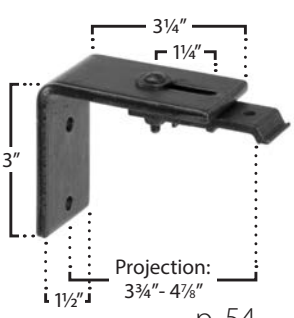
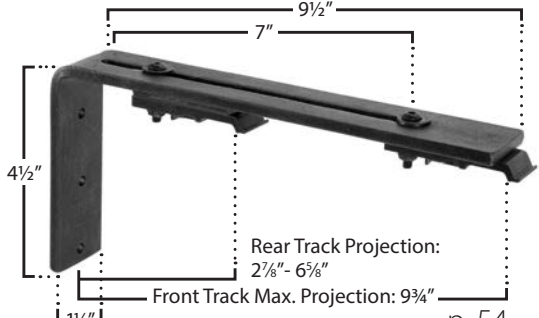
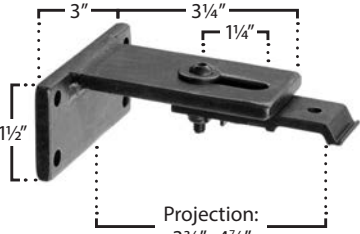
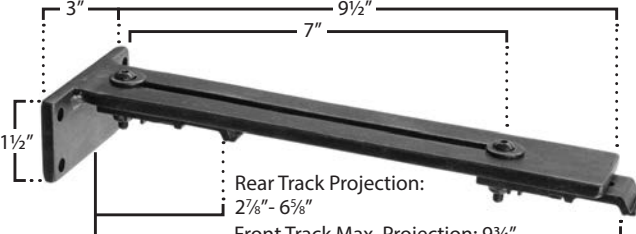
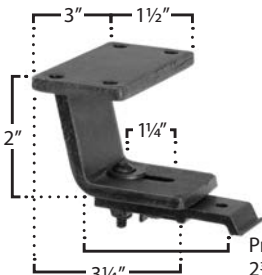
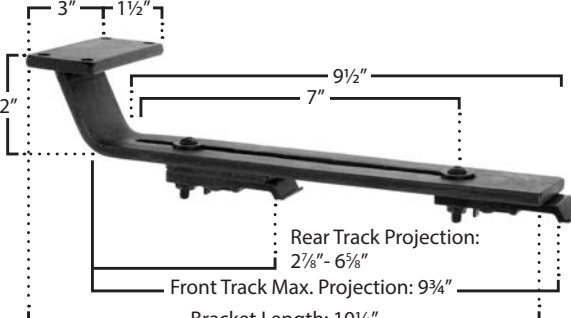
<p><b>Single End Bracket</b></p>  <p>Projection: 3¾" - 4⅞"</p> <p>p. 54</p> <p><b>DB1048EBS</b></p>	<p><b>Double End Bracket</b></p>  <p>Rear Track Projection: 2⅞" - 6⅝"</p> <p>Front Track Max. Projection: 9¾"</p> <p>p. 54</p> <p><b>DB1049EBD</b></p>
<p><b>Price Each</b></p> <p>\$28</p>	<p><b>Price Each</b></p> <p>\$42</p>
<p><b>Single Support Bracket</b></p>  <p>Projection: 3¾" - 4⅞"</p> <p>p. 54</p> <p><b>DB1050SBS</b></p>	<p><b>Double Support Bracket</b></p>  <p>Rear Track Projection: 2⅞" - 6⅝"</p> <p>Front Track Max. Projection: 9¾"</p> <p>p. 54</p> <p><b>DB1051SBD</b></p>
<p><b>Price Each</b></p> <p>\$28</p>	<p><b>Price Each</b></p> <p>\$42</p>
<p><b>Single Ceiling Bracket</b> (for systems without rings)</p>  <p>Projection: 2¾" - 3⅜"</p> <p>p. 54</p> <p><b>DB1052CBS-2</b></p>	<p><b>Double Ceiling Bracket</b> (for systems without rings)</p>  <p>Rear Track Projection: 2⅞" - 6⅝"</p> <p>Front Track Max. Projection: 9¾"</p> <p>Bracket Length: 10¼"</p> <p>p. 54</p> <p><b>DB1053CBD-2</b></p>
<p><b>Price Each</b></p> <p>\$28</p>	<p><b>Price Each</b></p> <p>\$42</p>

# MANUAL Traversing Poles: Brackets

## Manual Traversing - Additional Brackets

Space between double traversing tracks is 3¼" - 6⅞".

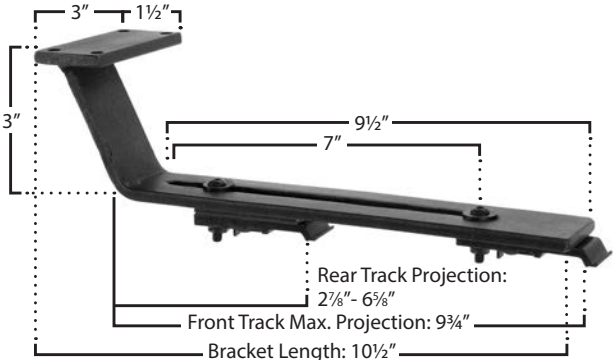
<p><b>Single Ceiling Bracket</b> (for systems with rings)</p>  <p><b>DB1052CBS-3</b></p>	<p><b>Double Ceiling Bracket</b> (for systems with rings)</p>  <p><b>DB1053CBD-3</b></p>
<p>Price Each      \$28</p>	<p>Price Each      \$42</p>

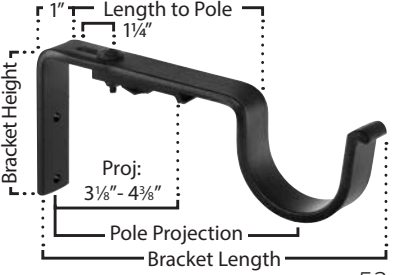
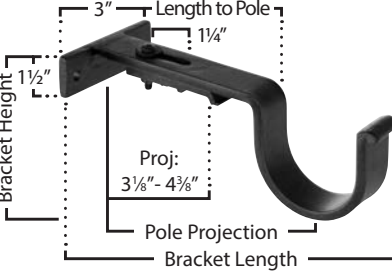
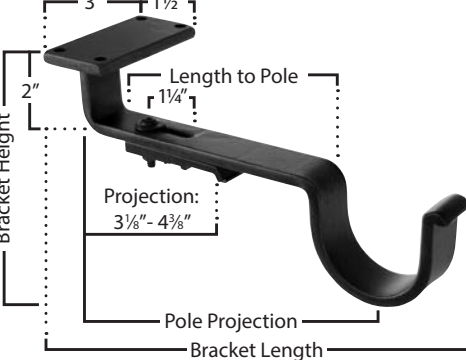
<p><b>Front Stationary / Rear Traversing End Bracket</b></p>  <p><b>DB1054EBD</b> For 1⅜" Poles 8¼" L x 4½" H LENGTH TO POLE: 6⅜" POLE PROJECTION: 7"</p> <p>For 2" Poles 8⅝" L x 4½" H LENGTH TO POLE: 6" POLE PROJECTION: 7⅛"</p> <p>For 2¼" Poles 8¾" L x 4½" H LENGTH TO POLE: 5⅞" POLE PROJECTION: 7⅛"</p> <p>For 3" Poles 10⅛" L x 5" H LENGTH TO POLE: 6½" POLE PROJECTION: 8¼"</p>	<p><b>Front Stationary / Rear Traversing Support Bracket</b></p>  <p><b>DB1055SBD</b> For 1⅜" Poles 8¼" L x 1¾" H LENGTH TO POLE: 6⅜" POLE PROJECTION: 7"</p> <p>For 2" Poles 8⅝" L x 2¼" H LENGTH TO POLE: 6" POLE PROJECTION: 7⅛"</p> <p>For 2¼" Poles 8¾" L x 2½" H LENGTH TO POLE: 5⅞" POLE PROJECTION: 7⅛"</p> <p>For 3" Poles 10⅛" L x 3⅛" H LENGTH TO POLE: 6½" POLE PROJECTION: 8¼"</p>	<p><b>Front Stationary / Rear Traversing Ceiling Bracket</b></p>  <p><b>DB1056CBD</b> For 1⅜" Poles 8¼" L x 3⅜" H LENGTH TO POLE: 6⅜" POLE PROJECTION: 7"</p> <p>For 2" Poles 8⅝" L x 4" H LENGTH TO POLE: 6" POLE PROJECTION: 7"</p> <p>For 2¼" Poles 8¾" L x 4¼" H LENGTH TO POLE: 5⅞" POLE PROJECTION: 7"</p> <p>For 3" Poles 10⅛" L x 5" H LENGTH TO POLE: 6½" POLE PROJECTION: 8"</p>
<p>Price Each      \$64</p>	<p>Price Each      \$64</p>	<p>Price Each      \$68</p>

# MANUAL Traversing Poles: Accessories

Additional Items for Manual Traversing Sets

## Additional Pinch Pleat Glides

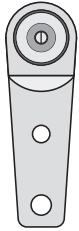

p. 54

### TRGLP

Available in White, Black, Antique Bronze or Gold to match track color. Please specify quantity in your order. Sets come standard with 4 per foot.

Price Each: \$2

## Additional RippleFold Glides

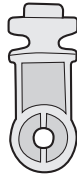

p. 54

### TRGLR

Available in White only. Please specify quantity in your order. (Sets come standard with number for selected fullness. Glides only - tape not included.)

Price Each: \$2

## Extra Master Carriers with Rings Pinch Pleat Only

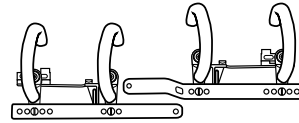

### Full Set with Rings DTMCSR

- One straight master carrier for rings.
- One overlap master carrier for rings.
- Four rings (two for each carrier).

Price: \$120

### Single Carrier with Rings DTMCR

- One straight or overlap master carrier for rings (please specify).
- Two rings.

Price: \$60

## Extra Master Carriers

Pinch Pleat or RippleFold  
(please specify in order)

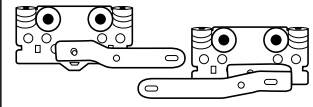

shown for pinch pleat

### Full Set DTMCS

- Overlap option for either includes:
  - One straight master carrier.
  - One overlap master carrier.
- Butt option for RippleFold includes:
  - Two butt master carriers.
- Please specify overlap or butt option for RippleFold.

Price: \$70

### Single Carrier DTMC

- One straight or overlap master carrier (please specify in order).

Price: \$35

## Iron Round Baton

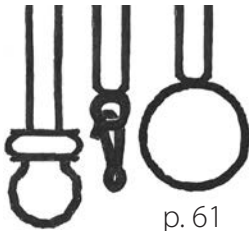

p. 61

Please Specify Ring or Clip

### DM1016

1/2" DIAMETER : 5/8" AFTER 73"

Custom Lengths Available

Length	Finish Group	
	A	B
12"-24"	\$52	\$58
25"-48"	\$62	\$68
49"-72"	\$80	\$88
73"-84"	\$100	\$110
85"-108"	\$124	\$138

## Iron Round Baton with Wood Handle



p. 61

Please Specify Ring or Clip

### DM1020

1/2" DIAMETER : 5/8" AFTER 73"

Custom Lengths Available

Length	Finish Group	
	A	B
12"-24"	\$52	\$58
25"-48"	\$62	\$68
49"-72"	\$80	\$88
73"-84"	\$100	\$110
85"-108"	\$124	\$138

## Wood Round Baton with Wood Handle



p. 61

### Clip Only DM5053

1/2" DIAMETER  
38" LONG

Finish Group

A	B	C
\$42	\$50	NA

## Wood Round Baton with Wood Handle

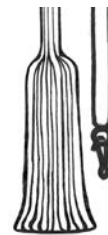

p. 61

### Clip Only DM5071







5/8" DIAMETER  
38" LONG

Finish Group

A	B	C
\$60	\$66	NA

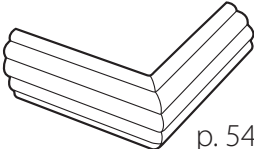
# MANUAL Traversing Poles: Accessories

## Additional Items for Manual Traversing Sets

<p style="text-align: center;"><b>Additional Traversing Cord</b></p>  <p style="text-align: center;"><b>TRCR</b></p> <p>Available in White only. Please specify length in your order. Sets come standard with 8 feet.</p> <table border="1" style="width: 100%; text-align: center;"> <tr><td><b>Price Per Foot</b></td></tr> <tr><td>\$.75</td></tr> </table>	<b>Price Per Foot</b>	\$.75	<p style="text-align: center;"><b>Miter Splice</b></p>  <p style="text-align: center;">For All Poles <b>DM5055</b></p> <p>For splices and corners like bay windows. Standard 45° or 90° angle connections. Contact customer service for any other custom angle. Wood glue is needed for a Miter Splice, and must be supplied by the installer. Please note, every splice should be reinforced with a bracket.</p> <table border="1" style="width: 100%; text-align: center;"> <tr><td><b>Price Each</b></td></tr> <tr><td>\$12</td></tr> </table>	<b>Price Each</b>	\$12	<p style="text-align: center;"><b>Miter Return</b></p>  <p style="text-align: right;">p. 54</p> <p style="text-align: center;">For All Poles <b>307MR</b></p> <p>Please specify return depth in your order. Standard return depths are 3½", 4½", 6", and 7" for single track systems, 9½" for double track systems.</p> <table border="1" style="width: 100%; text-align: center;"> <tr><td><b>Price Each</b></td></tr> <tr><td>\$54</td></tr> </table>	<b>Price Each</b>	\$54																														
<b>Price Per Foot</b>																																						
\$.75																																						
<b>Price Each</b>																																						
\$12																																						
<b>Price Each</b>																																						
\$54																																						
<p style="text-align: center;"><b>Smooth Traversing Ring</b></p>  <p style="text-align: right;">p. 54</p> <p>For 2" or 2¼" Poles <b>DGT5047-225</b></p> <p>½" THICK 2⅝" INNER DIAMETER 3⅝" OUTER DIAMETER</p> <p style="text-align: center;">Finish Group</p> <table border="1" style="width: 100%; text-align: center;"> <tr><th>A</th><th>B</th><th>C</th></tr> <tr><td>\$22</td><td>\$26</td><td>NA</td></tr> </table> <p>For 3" Poles <b>DGT5047-300</b></p> <p>⅞" THICK 3⅜" INNER DIAMETER 5⅛" OUTER DIAMETER</p> <p style="text-align: center;">Finish Group</p> <table border="1" style="width: 100%; text-align: center;"> <tr><th>A</th><th>B</th><th>C</th></tr> <tr><td>\$26</td><td>\$30</td><td>NA</td></tr> </table>	A	B	C	\$22	\$26	NA	A	B	C	\$26	\$30	NA	<p style="text-align: center;"><b>Fluted Traversing Ring</b></p>  <p style="text-align: right;">p. 54</p> <p>For 2" or 2¼" Poles <b>DGT5049-225</b></p> <p>¾" THICK 2¾" INNER DIAMETER 4¼" OUTER DIAMETER</p> <p style="text-align: center;">Finish Group</p> <table border="1" style="width: 100%; text-align: center;"> <tr><th>A</th><th>B</th><th>C</th></tr> <tr><td>\$22</td><td>\$26</td><td>\$30</td></tr> </table> <p>For 3" Poles <b>DGT5049-300</b></p> <p>⅞" THICK 3⅜" INNER DIAMETER 5⅛" OUTER DIAMETER</p> <p style="text-align: center;">Finish Group</p> <table border="1" style="width: 100%; text-align: center;"> <tr><th>A</th><th>B</th><th>C</th></tr> <tr><td>\$26</td><td>\$30</td><td>\$34</td></tr> </table>	A	B	C	\$22	\$26	\$30	A	B	C	\$26	\$30	\$34	<p style="text-align: center;"><b>Soprano Traversing Ring</b></p>  <p style="text-align: right;">p. 54</p> <p>For 2" or 2¼" Poles <b>DGT059-225</b></p> <p>⅝" THICK 2⅝" INNER DIAMETER 4⅜" OUTER DIAMETER</p> <p style="text-align: center;">Finish Group</p> <table border="1" style="width: 100%; text-align: center;"> <tr><th>A</th><th>B</th><th>C</th></tr> <tr><td>\$30</td><td>\$36</td><td>\$44</td></tr> </table> <p>For 3" Poles <b>DGT059-300</b></p> <p>⅝" THICK 3⅜" INNER DIAMETER 5" OUTER DIAMETER</p> <p style="text-align: center;">Finish Group</p> <table border="1" style="width: 100%; text-align: center;"> <tr><th>A</th><th>B</th><th>C</th></tr> <tr><td>\$34</td><td>\$40</td><td>\$48</td></tr> </table>	A	B	C	\$30	\$36	\$44	A	B	C	\$34	\$40	\$48
A	B	C																																				
\$22	\$26	NA																																				
A	B	C																																				
\$26	\$30	NA																																				
A	B	C																																				
\$22	\$26	\$30																																				
A	B	C																																				
\$26	\$30	\$34																																				
A	B	C																																				
\$30	\$36	\$44																																				
A	B	C																																				
\$34	\$40	\$48																																				

# MOTORIZED Traversing Poles

2", 2¼" and 3" Diameter Motorized Traversing Poles

## Pole Styles

Front Poles:

- Smooth, Fluted or Rope: 2", 2¼" and 3" Diameters
- Inlay: 2¼" and 3" Diameters

Back Poles (For Double):

- With Smooth, Fluted, or Rope Front: Matching 1⅜" Poles
- With Inlay Front: 1⅜" Smooth Pole

*Finished End Caps are included on all back rods.*

Miter Return Available (307MR)

## Finishes

For Front & Back Poles in Smooth, Fluted or Rope:

58 Décor Finishes, plus Custom Colors

For Front Inlay Poles Only:

58 Décor Finishes, Dual Finish System with

11 Accent Finishes, plus Custom Colors

*Custom Colors are additional charge.*

*Please contact customer service for a quote.*

## Sets Include

- Traversing Pole(s) Up to 30 Feet in Length
- Heavy Duty Track(s) in Antique Bronze, Black, Gold, Silver, & White  
Maximum fabric weight using the Glydea 60e motor is 132 pounds (with a straight track).
- Pinch Pleat or RippleFold Glides:  
Colored pinch pleat glides for systems with rings coordinate with track finishes (standard 4 per foot).  
Pinch pleat glides for systems without rings and RippleFold glides are white. RippleFold glides include snap tape.  
*Please state fullness of 80%, 100%, or 120% when ordering RippleFold.*
- Finished Master Carriers:  
Center open poles come with two master carriers, while one-way draw poles come with one.  
Front pole carriers each hold two rings (pinch pleat glides only).  
Pinch pleat available with one-way or overlap master carriers.  
RippleFold available with one-way, overlap or butt master carriers.
- Somfy Glydea 60e Heavy Duty Motor(s):
  - Radio frequency (RTS) drapery motor. Smooth & quiet operation (<44dBA).
  - Traverses up to 132 pounds.
  - Plugs directly into a standard 110 V AC duplex wall outlet (comes with 10 foot plug).
  - Manual override system allows drapery to be drawn during power outages.
  - Allows the user to activate the motorized drapery simply by pulling on the fabric.Include motor placement (left or right), and draw (left stack, right stack, or center open) in your order.
- Finished Motor Sleeve(s) and Pulley Cover(s) - Match Fascia
- Drapery Return Hook(s)
- Finished Brackets:
  - Two Heavy Duty End Brackets with Expandable Projections
  - Heavy Duty Support Brackets with Expandable Projections as Needed per Length  
*Specify wall or ceiling mount brackets when ordering. Due to limited clearance, we recommend using Rod-Enders with ceiling mount brackets. Please contact customer service for a list of other finials which may be used, or to create a bracket with a custom drop.*
- Finished End Caps (For Back Rods)

## Items Sold Separately

- Finials (pages 12-15), Rod-Enders (pages 18-19), Crystal and Bases (pages 23-29 and 36-37)
- Miter Return (307MR) (page 68)  
Standard Return Depths are 3½", 4½", 6", and 7" for single track systems, 9½" for double track systems.
- Control Options (page 69)
- Rings Styles For:
  - Traversing Poles (page 68)
  - Stationery Front Poles (pages 80-82)  
*Rings are available on front poles only using pinch pleat glides. Two stationary rings are placed on each end of the pole for center open systems, one ring is placed on the stack side for one-way draw systems. Front pole master carriers each hold two rings.*

## Splices and Shipping

- Somfy traversing tracks come assembled, are shipped in one piece, and are available up to 30' (360"). Poles over 16' (192") are spliced.
- The maximum width for a FedEx shipment is 8' 6" (102").  
*(New FedEx surcharge, above 96" in length per box will be added in addition to the shipping and handling charges.)*  
All sets over this must be shipped by common carrier (truck line). Please note residential truck deliveries are restricted to 24' (288").

## Measurement Guidelines

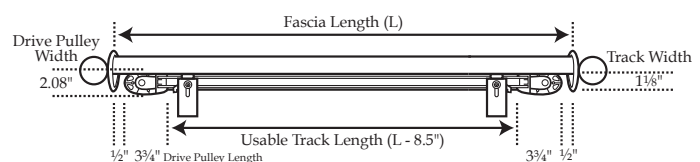

- Please specify fascia length when ordering.
- Usable track length will be 8½" shorter than fascia length. (L - 8½")



# MOTORIZED Traversing Poles: Single

2", 2¼" and 3" Diameter Single Motorized Traversing Poles

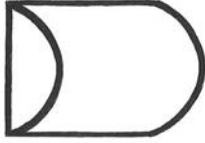
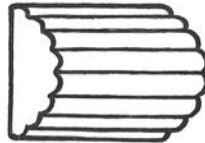
*Traversing set pricing is rounded up to the next foot.*

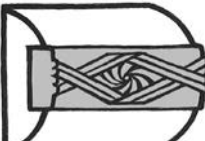
<b>Single Smooth Motorized Traversing Pole</b>		 p. 55								
Style	Set #	4 Feet	5 Feet	6 Feet	7 Feet	8 Feet	9 Feet	10 Feet	Additional Foot	
Smooth 2" Dia.	<b>DSTSM-S-200</b>	\$1,948	\$2,142	\$2,336	\$2,530	\$2,724	\$2,918	\$3,112	\$194	
Smooth 2¼" Dia.	<b>DSTSM-S-225</b>	\$1,948	\$2,142	\$2,336	\$2,530	\$2,724	\$2,918	\$3,112	\$194	
Smooth 3" Dia.	<b>DSTSM-S-300</b>	\$1,984	\$2,190	\$2,396	\$2,602	\$2,808	\$3,014	\$3,220	\$206	
<b>Single Fluted Motorized Traversing Pole</b>		 p. 55								
Style	Set #	4 Feet	5 Feet	6 Feet	7 Feet	8 Feet	9 Feet	10 Feet	Additional Foot	
Fluted 2" Dia.	<b>DSTFL-S-200</b>	\$1,948	\$2,142	\$2,336	\$2,530	\$2,724	\$2,918	\$3,112	\$194	
Fluted 2¼" Dia.	<b>DSTFL-S-225</b>	\$1,948	\$2,142	\$2,336	\$2,530	\$2,724	\$2,918	\$3,112	\$194	
Fluted 3" Dia.	<b>DSTFL-S-300</b>	\$1,984	\$2,190	\$2,396	\$2,602	\$2,808	\$3,014	\$3,220	\$206	
<b>Single Rope Motorized Traversing Pole</b>		 p. 55								
Style	Set #	4 Feet	5 Feet	6 Feet	7 Feet	8 Feet	9 Feet	10 Feet	Additional Foot	
Rope 2" Dia.	<b>DSTRP-S-200</b>	\$1,988	\$2,192	\$2,396	\$2,600	\$2,804	\$3,008	\$3,212	\$204	
Rope 2¼" Dia.	<b>DSTRP-S-225</b>	\$2,036	\$2,258	\$2,480	\$2,702	\$2,924	\$3,146	\$3,368	\$222	
Rope 3" Dia.	<b>DSTRP-S-300</b>	\$2,064	\$2,298	\$2,532	\$2,766	\$3,000	\$3,234	\$3,468	\$234	
<b>Single Inlay Motorized Traversing Pole</b>		 p. 55 When ordering, please include the Inlay design number from price list page 40 along with the pole number.								
Style	Set #	4 Feet	5 Feet	6 Feet	7 Feet	8 Feet	9 Feet	10 Feet	Additional Foot	
Inlay 2¼" Dia.	<b>DSTIN-S-225</b>	\$2,036	\$2,258	\$2,480	\$2,702	\$2,924	\$3,146	\$3,368	\$222	
Inlay 3" Dia.	<b>DSTIN-S-300</b>	\$2,064	\$2,298	\$2,532	\$2,766	\$3,000	\$3,234	\$3,468	\$234	

## Splice and Bracket Guide for Single or Double Motorized Traversing Sets

Length	Inches	36"-48"	48½"-84"	84½"-120"	120½"-156"	156½"-192"	192½"-228"	228½"-264"	264½"-300"	300½"-336"	336½"-360"
	Feet	3'-4'	4'-7'	7'-10'	10'-13'	13'-16'	16'-19'	19'-22'	22'-25'	25'-28'	28'-30'
Splices*		0	0	0	0	0	1	1	1	1	1
Brackets		3	4	5	6	7	8	9	10	11	12

\*Please see "Splices and Shipping" on page 62. Bracket numbers given here are a guide.

# MOTORIZED Traversing Poles: Double

2", 2¼" and 3" Diameter Double Motorized Traversing Poles

*Traversing set pricing is rounded up to the next foot. Back pole is 1½" diameter.*

## Double Smooth Motorized Traversing Poles

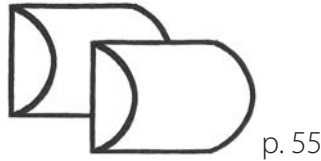

p. 55

Style	Set #	4 Feet	5 Feet	6 Feet	7 Feet	8 Feet	9 Feet	10 Feet	Additional Foot
Smooth 2" Dia.	<b>DSTSM-D-200</b>	\$3,998	\$4,258	\$4,518	\$4,778	\$5,038	\$5,298	\$5,558	\$260
Smooth 2¼" Dia.	<b>DSTSM-D-225</b>	\$3,998	\$4,258	\$4,518	\$4,778	\$5,038	\$5,298	\$5,558	\$260
Smooth 3" Dia.	<b>DSTSM-D-300</b>	\$4,198	\$4,468	\$4,738	\$5,008	\$5,278	\$5,548	\$5,818	\$270

## Double Fluted Motorized Traversing Poles

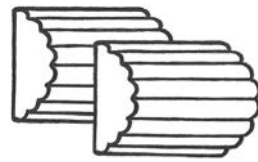

p. 55

Style	Set #	4 Feet	5 Feet	6 Feet	7 Feet	8 Feet	9 Feet	10 Feet	Additional Foot
Fluted 2" Dia.	<b>DSTFL-D-200</b>	\$3,998	\$4,258	\$4,518	\$4,778	\$5,038	\$5,298	\$5,558	\$260
Fluted 2¼" Dia.	<b>DSTFL-D-225</b>	\$3,998	\$4,258	\$4,518	\$4,778	\$5,038	\$5,298	\$5,558	\$260
Fluted 3" Dia.	<b>DSTFL-D-300</b>	\$4,198	\$4,468	\$4,738	\$5,008	\$5,278	\$5,548	\$5,818	\$270

## Double Rope Motorized Traversing Poles

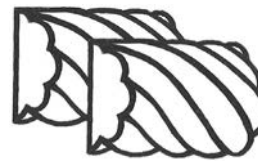

p. 55

Style	Set #	4 Feet	5 Feet	6 Feet	7 Feet	8 Feet	9 Feet	10 Feet	Additional Foot
Rope 2" Dia.	<b>DSTRP-D-200</b>	\$4,068	\$4,346	\$4,624	\$4,902	\$5,180	\$5,458	\$5,736	\$278
Rope 2¼" Dia.	<b>DSTRP-D-225</b>	\$4,076	\$4,358	\$4,640	\$4,922	\$5,204	\$5,486	\$5,768	\$282
Rope 3" Dia.	<b>DSTRP-D-300</b>	\$4,120	\$4,410	\$4,700	\$4,990	\$5,280	\$5,570	\$5,860	\$290

## Double with Inlay: Inlay Front, Smooth Back Motorized Traversing Poles

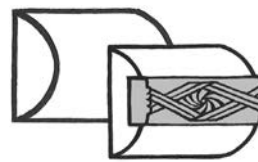

p. 55

When ordering, please include the Inlay design number from price list page 40 along with the pole number.

Style	Set #	4 Feet	5 Feet	6 Feet	7 Feet	8 Feet	9 Feet	10 Feet	Additional Foot
Inlay 2¼" Dia.	<b>DSTIN-D-225</b>	\$4,076	\$4,358	\$4,640	\$4,922	\$5,204	\$5,486	\$5,768	\$282
Inlay 3" Dia.	<b>DSTIN-D-300</b>	\$4,120	\$4,410	\$4,700	\$4,990	\$5,280	\$5,570	\$5,860	\$290





# MOTORIZED Traversing Poles: Double

2", 2¼" and 3" Diameter Stationary Front, Motorized Traversing Back Poles

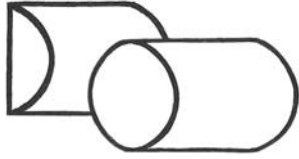
*Traversing set pricing is rounded up to the next foot. Back pole is 1½" diameter.*

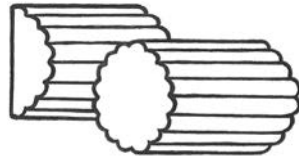
<b>Double Smooth: Stationary Front, Motorized Traversing Back</b>									
		p. 55							
Style	Set #	4 Feet	5 Feet	6 Feet	7 Feet	8 Feet	9 Feet	10 Feet	Additional Foot
Smooth 2" Dia.	<b>DRSTSM-D-200</b>	\$2,072	\$2,314	\$2,556	\$2,798	\$3,040	\$3,282	\$3,524	\$242
Smooth 2¼" Dia.	<b>DRSTSM-D-225</b>	\$2,072	\$2,314	\$2,556	\$2,798	\$3,040	\$3,282	\$3,524	\$242
Smooth 3" Dia.	<b>DRSTSM-D-300</b>	\$2,176	\$2,436	\$2,696	\$2,956	\$3,216	\$3,476	\$3,736	\$260

<b>Double Fluted: Stationary Front, Motorized Traversing Back</b>									
		p. 55							
Style	Set #	4 Feet	5 Feet	6 Feet	7 Feet	8 Feet	9 Feet	10 Feet	Additional Foot
Fluted 2" Dia.	<b>DRSTFL-D-200</b>	\$2,072	\$2,314	\$2,556	\$2,798	\$3,040	\$3,282	\$3,524	\$242
Fluted 2¼" Dia.	<b>DRSTFL-D-225</b>	\$2,072	\$2,314	\$2,556	\$2,798	\$3,040	\$3,282	\$3,524	\$242
Fluted 3" Dia.	<b>DRSTFL-D-300</b>	\$2,176	\$2,436	\$2,696	\$2,956	\$3,216	\$3,476	\$3,736	\$260

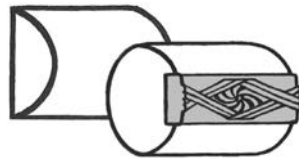

<b>Double Rope: Stationary Front, Motorized Traversing Back</b>									
		p. 55							
Style	Set #	4 Feet	5 Feet	6 Feet	7 Feet	8 Feet	9 Feet	10 Feet	Additional Foot
Rope 2" Dia.	<b>DRSTRP-D-200</b>	\$2,224	\$2,494	\$2,764	\$3,034	\$3,304	\$3,574	\$3,844	\$270
Rope 2¼" Dia.	<b>DRSTRP-D-225</b>	\$2,252	\$2,530	\$2,808	\$3,086	\$3,364	\$3,642	\$3,920	\$278
Rope 3" Dia.	<b>DRSTRP-D-300</b>	\$2,296	\$2,598	\$2,900	\$3,202	\$3,504	\$3,806	\$4,108	\$302

<b>Double with Inlay: Stationary Inlay Front, Smooth Motorized Traversing Back</b>									
		p. 55							
		When ordering, please include the Inlay design number from price list page 40 along with the pole number.							
Style	Set #	4 Feet	5 Feet	6 Feet	7 Feet	8 Feet	9 Feet	10 Feet	Additional Foot
Inlay 2¼" Dia.	<b>DRSTIN-D-225</b>	\$2,252	\$2,530	\$2,808	\$3,086	\$3,364	\$3,642	\$3,920	\$278
Inlay 3" Dia.	<b>DRSTIN-D-300</b>	\$2,296	\$2,598	\$2,900	\$3,202	\$3,504	\$3,806	\$4,108	\$302

# MOTORIZED Traversing Poles: Brackets

## Motorized Traversing - Additional Brackets

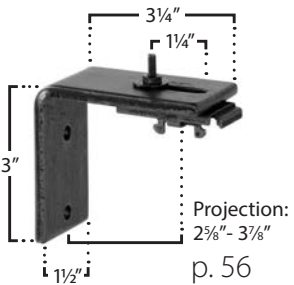
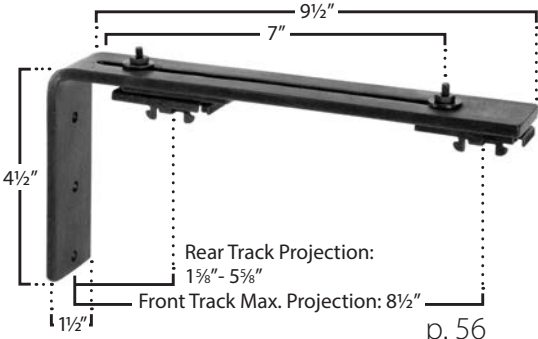
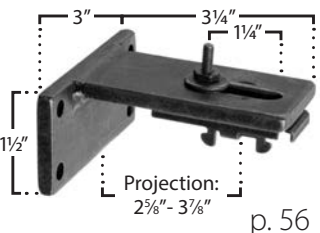
Space between double traversing tracks is 2 $\frac{1}{8}$ " - 6 $\frac{3}{4}$ ".

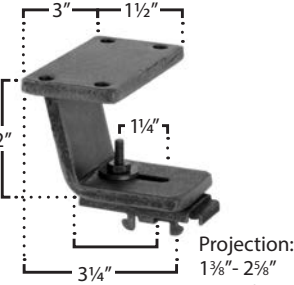
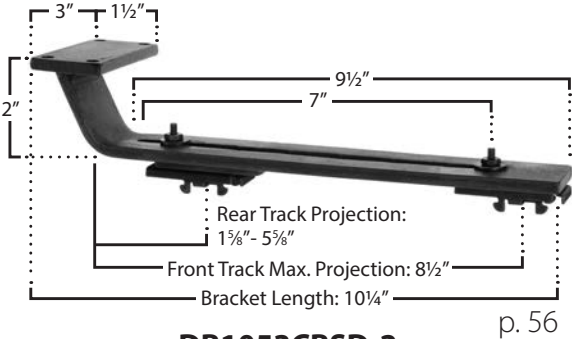
<p><b>Single End Bracket</b></p>  <p>Projection: 2<math>\frac{5}{8}</math>" - 3<math>\frac{7}{8}</math>" p. 56</p> <p><b>DB1048EBSS</b></p>	<p><b>Double End Bracket</b></p>  <p>Rear Track Projection: 1<math>\frac{3}{8}</math>" - 5<math>\frac{5}{8}</math>" Front Track Max. Projection: 8<math>\frac{1}{2}</math>" p. 56</p> <p><b>DB1049EBSD</b></p>
<p><b>Price Each</b></p> <p>\$28</p>	<p><b>Price Each</b></p> <p>\$42</p>
<p><b>Single Support Bracket</b></p>  <p>Projection: 2<math>\frac{5}{8}</math>" - 3<math>\frac{7}{8}</math>" p. 56</p> <p><b>DB1050SBSS</b></p>	<p><b>Double Support Bracket</b></p>  <p>Rear Track Projection: 1<math>\frac{3}{8}</math>" - 5<math>\frac{5}{8}</math>" Front Track Max. Projection: 8<math>\frac{1}{2}</math>" p. 56</p> <p><b>DB1051SBSD</b></p>
<p><b>Price Each</b></p> <p>\$28</p>	<p><b>Price Each</b></p> <p>\$42</p>
<p><b>Single Ceiling Bracket</b> (for systems without rings)</p>  <p>Projection: 1<math>\frac{3}{8}</math>" - 2<math>\frac{5}{8}</math>" p. 56</p> <p><b>DB1052CBSS-2</b></p>	<p><b>Double Ceiling Bracket</b> (for systems without rings)</p>  <p>Rear Track Projection: 1<math>\frac{3}{8}</math>" - 5<math>\frac{5}{8}</math>" Front Track Max. Projection: 8<math>\frac{1}{2}</math>" Bracket Length: 10<math>\frac{1}{4}</math>" p. 56</p> <p><b>DB1053CBSD-2</b></p>
<p><b>Price Each</b></p> <p>\$28</p>	<p><b>Price Each</b></p> <p>\$42</p>

# MOTORIZED Traversing Poles: Brackets

## Motorized Traversing - Additional Brackets

Space between double traversing tracks is 2 $\frac{7}{8}$ " - 6 $\frac{3}{4}$ ".

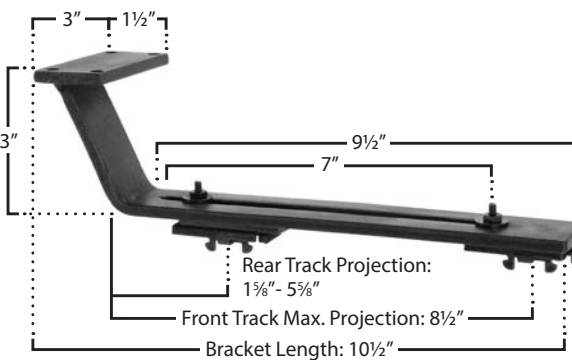
<p><b>Single Ceiling Bracket</b> (for systems with rings)</p>  <p><b>DB1052CBSS-3</b></p>	<p><b>Double Ceiling Bracket</b> (for systems with rings)</p>  <p><b>DB1053CBSD-3</b></p>
<p><b>Price Each</b>      \$28</p>	<p><b>Price Each</b>      \$42</p>

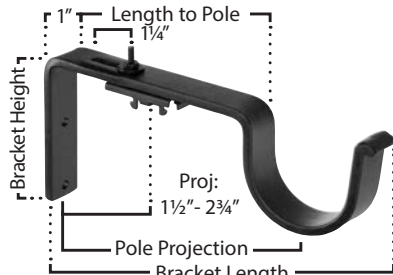
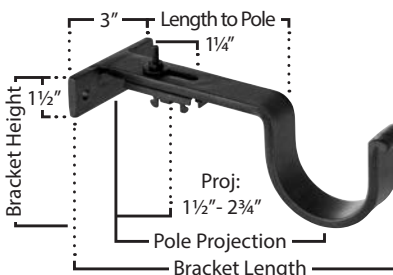
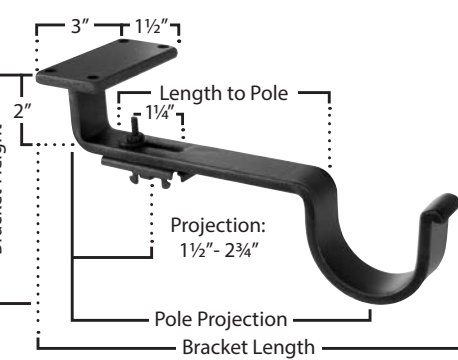
<p><b>Front Stationary / Rear Traversing End Bracket</b></p>  <p><b>DB1054EBSD</b> For 1<math>\frac{3}{8}</math>" Poles 8<math>\frac{1}{4}</math>" L x 4<math>\frac{1}{2}</math>" H LENGTH TO POLE: 6<math>\frac{3}{8}</math>" POLE PROJECTION: 7"</p> <p>For 2" Poles 8<math>\frac{5}{8}</math>" L x 4<math>\frac{1}{2}</math>" H LENGTH TO POLE: 6" POLE PROJECTION: 7<math>\frac{1}{8}</math>"</p> <p>For 2<math>\frac{1}{4}</math>" Poles 8<math>\frac{3}{4}</math>" L x 4<math>\frac{1}{2}</math>" H LENGTH TO POLE: 5<math>\frac{7}{8}</math>" POLE PROJECTION: 7<math>\frac{1}{8}</math>"</p> <p>For 3" Poles 10<math>\frac{1}{8}</math>" L x 5" H LENGTH TO POLE: 6<math>\frac{1}{2}</math>" POLE PROJECTION: 8<math>\frac{1}{4}</math>"</p>	<p><b>Front Stationary / Rear Traversing Support Bracket</b></p>  <p><b>DB1055SBSD</b> For 1<math>\frac{3}{8}</math>" Poles 8<math>\frac{1}{4}</math>" L x 1<math>\frac{3}{4}</math>" H LENGTH TO POLE: 6<math>\frac{3}{8}</math>" POLE PROJECTION: 7"</p> <p>For 2" Poles 8<math>\frac{5}{8}</math>" L x 2<math>\frac{1}{4}</math>" H LENGTH TO POLE: 6" POLE PROJECTION: 7<math>\frac{1}{8}</math>"</p> <p>For 2<math>\frac{1}{4}</math>" Poles 8<math>\frac{3}{4}</math>" L x 2<math>\frac{1}{2}</math>" H LENGTH TO POLE: 5<math>\frac{7}{8}</math>" POLE PROJECTION: 7<math>\frac{1}{8}</math>"</p> <p>For 3" Poles 10<math>\frac{1}{8}</math>" L x 3<math>\frac{1}{8}</math>" H LENGTH TO POLE: 6<math>\frac{1}{2}</math>" POLE PROJECTION: 8<math>\frac{1}{4}</math>"</p>	<p><b>Front Stationary / Rear Traversing Ceiling Bracket</b></p>  <p><b>DB1056CBSD</b> For 1<math>\frac{3}{8}</math>" Poles 8<math>\frac{1}{4}</math>" L x 3<math>\frac{3}{8}</math>" H LENGTH TO POLE: 6<math>\frac{3}{8}</math>" POLE PROJECTION: 7"</p> <p>For 2" Poles 8<math>\frac{5}{8}</math>" L x 4" H LENGTH TO POLE: 6" POLE PROJECTION: 7"</p> <p>For 2<math>\frac{1}{4}</math>" Poles 8<math>\frac{3}{4}</math>" L x 4<math>\frac{1}{4}</math>" H LENGTH TO POLE: 5<math>\frac{7}{8}</math>" POLE PROJECTION: 7"</p> <p>For 3" Poles 10<math>\frac{1}{8}</math>" L x 5" H LENGTH TO POLE: 6<math>\frac{1}{2}</math>" POLE PROJECTION: 8"</p>
<p><b>Price Each</b>      \$64</p>	<p><b>Price Each</b>      \$64</p>	<p><b>Price Each</b>      \$68</p>

# MOTORIZED Traversing Poles: Accessories

## Additional Items for Motorized Traversing Sets

### Additional Pinch Pleat Glides

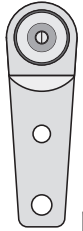

p. 54

#### TRGLP

Available in White, Black, Antique Bronze or Gold to match track color. Please specify quantity in your order. Sets come standard with 4 per foot.

Price Each: \$2

### Additional RippleFold Glides

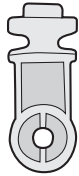

p. 54

#### TRGLR

Available in White only. Please specify quantity in your order. (Sets come standard with number for selected fullness. Glides only - tape not included.)

Price Each: \$2

### Miter Splice



#### For All Poles DM5055

For corners and special applications like bay windows. Standard 45° or 90° angle connections. Contact customer service for any other custom angle. Wood glue is needed for a Miter Splice, and must be supplied by the installer. Please note, every splice should be reinforced with a bracket.

Price Each: \$12

### Miter Return

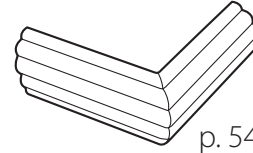

p. 54

#### For All Poles 307MR

Please specify return depth in your order. Standard return depths are 3½", 4½", 6", and 7" for single track systems, 9½" for double track systems.

Price: \$54

### Extra Master Carriers with Rings Pinch Pleat Only

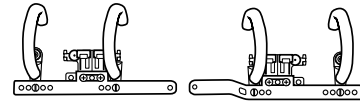

#### Full Set with Rings DSTMCSR

- One straight master carrier for rings.
- One overlap master carrier for rings.
- Four rings (two for each carrier).

Price: \$220

### Single Carrier with Rings DSTMCR

- One straight or overlap master carrier for rings (please specify).
- Two rings.

Price: \$110

### Extra Master Carriers Pinch Pleat or RippleFold (please specify in order)

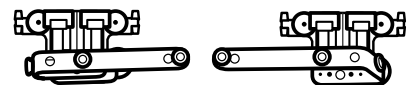

#### Full Set DSTMCS

shown as overlap

- Overlap option for Pinch Pleat or RippleFold includes:
  - One straight master carrier.
  - One overlap master carrier.
- Butt option for RippleFold includes:
  - Two butt master carriers.
- Please specify overlap or butt option for RippleFold.

Price: \$110

### Single Carrier DSTMC

- One overlap master carrier.

Price: \$55

### Smooth Traversing Ring



p. 56

#### For 2" or 2¼" Poles DGT5047-225

½" THICK  
2⅝" INNER DIAMETER  
3⅝" OUTER DIAMETER  
Finish Group

A	B	C
\$22	\$26	NA

#### For 3" Poles DGT5047-300

⅞" THICK  
3⅜" INNER DIAMETER  
5⅛" OUTER DIAMETER  
Finish Group

A	B	C
\$26	\$30	NA

### Fluted Traversing Ring



p. 56

#### For 2" or 2¼" Poles DGT5049-225

¾" THICK  
2¾" INNER DIAMETER  
4¼" OUTER DIAMETER  
Finish Group

A	B	C
\$22	\$26	\$30

#### For 3" Poles DGT5049-300

⅞" THICK  
3⅜" INNER DIAMETER  
5⅛" OUTER DIAMETER  
Finish Group

A	B	C
\$26	\$30	\$34

### Soprano Traversing Ring



p. 56

#### For 2" or 2¼" Poles DGT5059-225

⅝" THICK  
2⅝" INNER DIAMETER  
4⅜" OUTER DIAMETER  
Finish Group

A	B	C
\$30	\$36	\$44

#### For 3" Poles DGT5059-300

⅝" THICK  
3⅜" INNER DIAMETER  
5" OUTER DIAMETER  
Finish Group

A	B	C
\$34	\$40	\$48

# MOTORIZED Traversing Poles: Controls

## Motor Controls and Additional Motors

The DecoFlex WireFree RTS is a battery-powered and completely wireless wall switch that provides an ideal way to control motorized products when entering or exiting a room. Each channel can control an individual motorized product or a group of motorized product which provides practical and flexible control options. It's compatible with all Radio Technology Somfy motorized products.

The Telis RTS is a convenient hand-held remote. Instantly create the ideal natural light environment without having to interrupt your activity with a simple button press. The remote is omni-directional, so there is no need to aim the remote at the product being controlled. Exclusive Somfy MY feature saves a favorite/preferred product position without having to fine tune it each time.

**DecoFlex WireFree RTS Wall Switch**

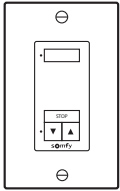

p. 56

**1 Channel**  
2¾"W x 4½"H  
RADIO FREQUENCY: 433.42 MHZ  
RANGE: 65 FEET  
**White**  
**STSW1-WH**

<b>Price Each:</b>	\$319
<b>Ivory</b> <b>STSW1-IV</b>	
<b>Price Each:</b>	\$319
<b>Black</b> <b>STSW1-BL</b>	
<b>Price Each:</b>	\$368

**DecoFlex WireFree RTS Wall Switch**

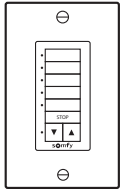

p. 56

**5 Channel**  
2¾"W x 4½"H  
RADIO FREQUENCY: 433.42 MHZ  
RANGE: 65 FEET  
**White**  
**STSW5-WH**

<b>Price Each:</b>	\$335
<b>Ivory</b> <b>STSW5-IV</b>	
<b>Price Each:</b>	\$335
<b>Black</b> <b>STSW5-BL</b>	
<b>Price Each:</b>	\$386

**Telis RTS Remote Control**



p. 56

**1 Channel**  
1¾"W x 5¼"H  
RADIO FREQUENCY: 433.42 MHZ  
RANGE: 65 FEET  
**Pure**  
**STRP1-PR**

<b>Price Each:</b>	\$137
<b>Silver</b> <b>STRP1-SL</b>	
<b>Price Each:</b>	\$214
<b>Black</b> <b>STRP1-BL</b>	
<b>Price Each:</b>	\$214

**Telis RTS Remote Control**

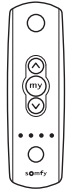

p. 56

**5 Channel**  
1¾"W x 5¼"H  
RADIO FREQUENCY: 433.42 MHZ  
RANGE: 65 FEET  
**Pure**  
**STRP5-PR**

<b>Price Each:</b>	\$178
<b>Silver</b> <b>STRP5-SL</b>	
<b>Price Each:</b>	\$260
<b>Black</b> <b>STRP5-BL</b>	
<b>Price Each:</b>	\$260

**Telis 1 Chronis RTS Remote Control**

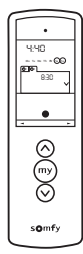

p. 56

**1 Channel**  
17⁄8"W x 5¾"H  
RADIO FREQUENCY: 433.42 MHZ  
RANGE: 65 FEET  
**Silver Star**  
**STRP1-SS**

<b>Price Each:</b>	\$480
--------------------	-------

The Telis 1 Chronis RTS combines the functionality of a single channel RTS hand-held control with the convenience of a programmable timer. It is compatible with all RTS motorized applications and offers simple programming and easy operation.

**Somfy myLink™**



**5 Channel**  
Control Somfy motors through a smart phone or tablet. Consists of a simple plug-in device and free app. Does not replace a preprogrammed RTS control.  
**STAPP**

<b>Price Each:</b>	\$380
--------------------	-------

**Glydea 60e RTS Motor**



p. 55

3⅝"W x 11½"H x 2"D  
POWER SUPPLY: 110 V 50/60 HZ  
POWER CONSUMPTION: 120 W  
MAXIMUM WEIGHT: 132 LBS  
**60e Motor**  
**SMTR60E**

<b>Price Each:</b>	\$1,000
--------------------	---------

With Somfy's Glydea™ 60e motor, simply press a button on your wireless wall switch or hand-held remote control, and your motorized curtains open smoothly and quietly.

- Smooth, Quiet & Powerful Operation:
- Radio frequency (RTS) drapery motor.
  - Soft start and soft stop.
  - Motor design and the use of a timing belt provides quiet operation (<44dBA).
  - Adjustable speed: 4.9"/s to 7.86"/s.
  - Traverses up to 132 lbs.

- Easy Installation and Use:
- Spring loaded one-touch hardware.
  - Motor plugs directly into a standard 110 V AC duplex wall outlet (comes with 10ft. plug).
  - "My Function" allows user to set a preferred drapery openness position for easy access.
  - "Touch Motion" with two sensitivity settings activates the motorized drapery simply by pulling on the fabric.
  - Manual override disengages the motor. This is ideal for power outages and protects fabric from damage.

# ACCESSORIES



# ACCESSORIES

## DETAILS

- Design Art offers brackets (standard, accent, decorative and iron), batons (wood and iron), rings (standard, decorative and iron), holdbacks, and adornments in many sizes and styles to fulfill all your design desires.
- Due to the nature of hand-crafted items, dimensions may vary slightly from piece to piece. Items in the same order will be matched as closely as possible when ordered.

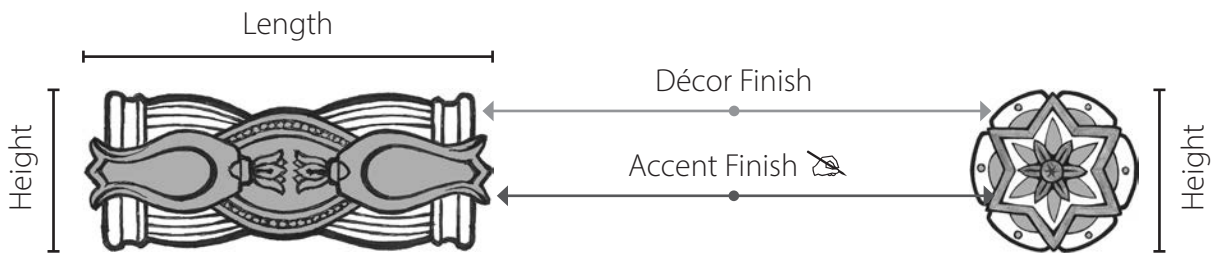
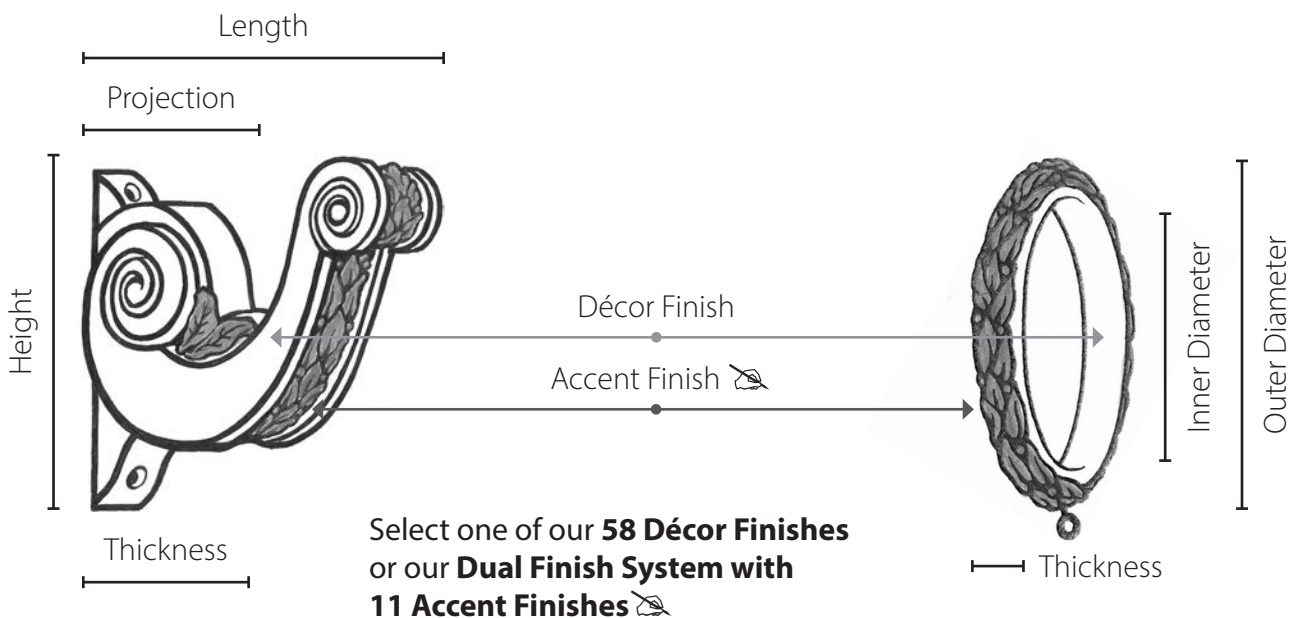

When ordering complete drapery hardware sets and accessories don't forget to include:

- Finials (pages 12-15)
- Rod-Enders (pages 18-19)
- Crystal and Bases (pages 23-29 and 36-37)
- Poles (1 3/8", 2" 2 1/4" or 3") (pages 48-49)

\* optional

# ACCESSORIES: Wood Item Guide

Below is a list of our wood accessories, and what poles diameters each is available for.

Item Name / Type	Price List Page	Available for Pole Diameter:				Available with Dual Finish System Accent Finishes 
		1 <sup>3</sup> / <sub>8</sub> "	2"	2 <sup>1</sup> / <sub>4</sub> "	3"	
<b>Standard Brackets</b>						
American	74	X	X	X	X	Yes
European	74	X	X	X	X	No
Rectangle	75		X	X	X	No
<b>Accent Brackets</b>						
Decal	75		X	X	X	Yes
Opera	76		X	X	X	Yes
Sonnet	76		X	X	X	Yes
<b>Decorative Brackets</b>						
Doublet	76		X	X		Yes
Inlay	77		X	X	X	Yes
Poetry	77		X	X		Yes
Prose	77	X	X	X		Yes
Rhythm	77		X	X		Yes
<b>Sockets &amp; End Caps</b>						
Laurel Wreath Socket	78		X	X	X	Yes
Standard Socket	78	X	X	X		No
Swivel Elbow	78	X	X	X		No
End Cap	78	X	X	X	X	No
<b>Wood Rings</b>						
Smooth	80	X	X	X	X	No
Fluted	80	X	X	X	X	Yes
Coronet	80		X	X	X	Yes
Paisley	80		X	X	X	Yes
Pinwheel	81		X	X	X	Yes
Regalia	81		X	X	X	Yes
Soprano	81	X	X	X	X	Yes
Tiara	81		X	X	X	Yes
<b>Centerpieces</b>						
Hallmark	87		X	X		Yes
Signet	87		X	X		Yes

As a general guideline, we recommend brackets every 4 feet.



# ACCESSORIES: Iron Item Guide

Below is a list of our iron accessories, and what poles diameters each is available for.



Item Name / Type	Price List Page	Available for Pole Diameter:				Available with Dual Finish System Accent Finishes 
		1 <sup>3</sup> / <sub>8</sub> "	2"	2 <sup>1</sup> / <sub>4</sub> "	3"	
<b>Iron Rings</b>						
Round	82	X	X	X	X	No
Hammered	82	X	X	X	X	No
Twisted	82	X	X	X	X	No
<b>Iron Brackets</b>						
End Bracket with Lip	83	X	X	X	X	No
End Bracket	83	X	X	X	X	No
Support Bracket with Lip	84	X	X	X	X	No
Double Support Bracket with Lip	84	X	X	X	X	No
Double Support Bracket	84	X	X	X	X	No
Ceiling Bracket	85	X	X	X	X	No
Socket Bracket	85	X	X	X	X	No
Eyelet Bracket	85	X	X	X	X	No



As a general guideline, we recommend brackets every 4 feet.

# ACCESSORIES: Brackets

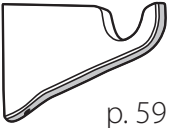
Standard brackets for 1 $\frac{3}{8}$ ", 2", 2 $\frac{1}{4}$ " and 3" diameter poles.

*Not Available with Dual Finish System Accent Finishes.*

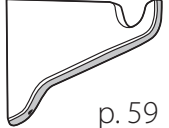
<p><b>American Bracket</b></p>  <p>p. 59</p> <p>For 1<math>\frac{3}{8}</math>" Poles <b>DB5045-4P-138</b> 5<math>\frac{1}{4}</math>" L x 6<math>\frac{3}{4}</math>" H 7/8" THICK; 3<math>\frac{3}{4}</math>" PROJECTION Finish Group</p> <table border="1"> <tr> <th>A</th> <th>B</th> <th>C</th> </tr> <tr> <td>\$32</td> <td>\$38</td> <td>\$44</td> </tr> </table>			A	B	C	\$32	\$38	\$44
A	B	C						
\$32	\$38	\$44						
 <p>p. 59</p> <p>For 2" Poles <b>DB5045-4P-200</b> 6<math>\frac{3}{8}</math>" L x 6<math>\frac{3}{4}</math>" H 7/8" THICK; 4" PROJECTION Finish Group</p> <table border="1"> <tr> <th>A</th> <th>B</th> <th>C</th> </tr> <tr> <td>\$38</td> <td>\$46</td> <td>\$56</td> </tr> </table>			A	B	C	\$38	\$46	\$56
A	B	C						
\$38	\$46	\$56						
<p>For 2<math>\frac{1}{4}</math>" Poles <b>DB5045-4P-225</b> 6<math>\frac{1}{2}</math>" L x 6<math>\frac{7}{8}</math>" H 1" THICK; 4<math>\frac{1}{4}</math>" PROJECTION Finish Group</p> <table border="1"> <tr> <th>A</th> <th>B</th> <th>C</th> </tr> <tr> <td>\$38</td> <td>\$46</td> <td>\$56</td> </tr> </table>			A	B	C	\$38	\$46	\$56
A	B	C						
\$38	\$46	\$56						
<p>For 3" Poles <b>DB5045-5P-300</b> 7<math>\frac{3}{8}</math>" L x 8" H 1" THICK; 4<math>\frac{5}{8}</math>" PROJECTION Finish Group</p> <table border="1"> <tr> <th>A</th> <th>B</th> <th>C</th> </tr> <tr> <td>\$46</td> <td>\$52</td> <td>\$68</td> </tr> </table>			A	B	C	\$46	\$52	\$68
A	B	C						
\$46	\$52	\$68						

<p><b>American Bracket</b></p>  <p>p. 59</p> <p>For 1<math>\frac{3}{8}</math>" Poles <b>DB5045-7P-138</b> 8<math>\frac{1}{8}</math>" L x 6<math>\frac{3}{4}</math>" H 3/4" THICK; 6<math>\frac{1}{2}</math>" PROJECTION Finish Group</p> <table border="1"> <tr> <th>A</th> <th>B</th> <th>C</th> </tr> <tr> <td>\$36</td> <td>\$42</td> <td>\$52</td> </tr> </table>			A	B	C	\$36	\$42	\$52
A	B	C						
\$36	\$42	\$52						
 <p>p. 59</p> <p>For 2" Poles <b>DB5045-7P-200</b> 9<math>\frac{1}{8}</math>" L x 6<math>\frac{3}{4}</math>" H 1" THICK; 7" PROJECTION Finish Group</p> <table border="1"> <tr> <th>A</th> <th>B</th> <th>C</th> </tr> <tr> <td>\$44</td> <td>\$50</td> <td>\$58</td> </tr> </table>			A	B	C	\$44	\$50	\$58
A	B	C						
\$44	\$50	\$58						
<p>For 2<math>\frac{1}{4}</math>" Poles <b>DB5045-7P-225</b> 9<math>\frac{1}{2}</math>" L x 6<math>\frac{3}{4}</math>" H 1" THICK; 7<math>\frac{1}{4}</math>" PROJECTION Finish Group</p> <table border="1"> <tr> <th>A</th> <th>B</th> <th>C</th> </tr> <tr> <td>\$44</td> <td>\$50</td> <td>\$58</td> </tr> </table>			A	B	C	\$44	\$50	\$58
A	B	C						
\$44	\$50	\$58						
<p>For 3" Poles <b>DB5045-8P-300</b> 9<math>\frac{1}{2}</math>" L x 7<math>\frac{3}{4}</math>" H 1" THICK; 7<math>\frac{1}{2}</math>" PROJECTION Finish Group</p> <table border="1"> <tr> <th>A</th> <th>B</th> <th>C</th> </tr> <tr> <td>\$54</td> <td>\$58</td> <td>\$64</td> </tr> </table>			A	B	C	\$54	\$58	\$64
A	B	C						
\$54	\$58	\$64						

<p><b>European Bracket*</b></p>  <p>p. 59</p> <p>For 1<math>\frac{3}{8}</math>" Poles <b>DB5046-4P-138</b> 5" L x 2<math>\frac{3}{8}</math>" H 2<math>\frac{3}{8}</math>" THICK; 2<math>\frac{3}{8}</math>" THICK AT WALL; 3<math>\frac{5}{8}</math>" PROJECTION Finish Group</p> <table border="1"> <tr> <th>A</th> <th>B</th> <th>C</th> </tr> <tr> <td>\$28</td> <td>\$34</td> <td>NA</td> </tr> </table>			A	B	C	\$28	\$34	NA
A	B	C						
\$28	\$34	NA						
<p>For 2" Poles <b>DB5046-4P-200</b> 5<math>\frac{5}{8}</math>" L x 2<math>\frac{3}{8}</math>" H 2<math>\frac{3}{8}</math>" THICK; 2<math>\frac{3}{8}</math>" THICK AT WALL; 3<math>\frac{7}{8}</math>" PROJECTION Finish Group</p> <table border="1"> <tr> <th>A</th> <th>B</th> <th>C</th> </tr> <tr> <td>\$42</td> <td>\$46</td> <td>NA</td> </tr> </table>			A	B	C	\$42	\$46	NA
A	B	C						
\$42	\$46	NA						
<p>For 2<math>\frac{1}{4}</math>" Poles <b>DB5046-4P-225</b> 5<math>\frac{5}{8}</math>" L x 2<math>\frac{3}{8}</math>" H 2<math>\frac{3}{8}</math>" THICK; 2<math>\frac{3}{8}</math>" THICK AT WALL; 3<math>\frac{7}{8}</math>" PROJECTION Finish Group</p> <table border="1"> <tr> <th>A</th> <th>B</th> <th>C</th> </tr> <tr> <td>\$42</td> <td>\$46</td> <td>NA</td> </tr> </table>			A	B	C	\$42	\$46	NA
A	B	C						
\$42	\$46	NA						
<p>For 3" Poles <b>DB5046-5P-300</b> 6<math>\frac{3}{4}</math>" L x 2<math>\frac{3}{8}</math>" H 2<math>\frac{3}{8}</math>" THICK; 2<math>\frac{3}{8}</math>" THICK AT WALL; 4<math>\frac{1}{2}</math>" PROJECTION Finish Group</p> <table border="1"> <tr> <th>A</th> <th>B</th> <th>C</th> </tr> <tr> <td>\$60</td> <td>\$66</td> <td>NA</td> </tr> </table>			A	B	C	\$60	\$66	NA
A	B	C						
\$60	\$66	NA						

<p><b>European Bracket*</b></p>  <p>p. 59</p> <p>For 1<math>\frac{3}{8}</math>" Poles <b>DB5046-7P-138</b> 7<math>\frac{7}{8}</math>" L x 2<math>\frac{3}{8}</math>" H 2<math>\frac{3}{8}</math>" THICK; 2<math>\frac{3}{8}</math>" THICK AT WALL; 6<math>\frac{1}{2}</math>" PROJECTION Finish Group</p> <table border="1"> <tr> <th>A</th> <th>B</th> <th>C</th> </tr> <tr> <td>\$36</td> <td>\$42</td> <td>NA</td> </tr> </table>			A	B	C	\$36	\$42	NA
A	B	C						
\$36	\$42	NA						
<p>For 2" Poles <b>DB5046-7P-200</b> 8<math>\frac{5}{8}</math>" L x 2<math>\frac{3}{8}</math>" H 2<math>\frac{3}{8}</math>" THICK; 2<math>\frac{3}{8}</math>" THICK AT WALL; 6<math>\frac{3}{4}</math>" PROJECTION Finish Group</p> <table border="1"> <tr> <th>A</th> <th>B</th> <th>C</th> </tr> <tr> <td>\$48</td> <td>\$56</td> <td>NA</td> </tr> </table>			A	B	C	\$48	\$56	NA
A	B	C						
\$48	\$56	NA						
<p>For 2<math>\frac{1}{4}</math>" Poles <b>DB5046-7P-225</b> 8<math>\frac{5}{8}</math>" L x 2<math>\frac{3}{8}</math>" H 2<math>\frac{3}{8}</math>" THICK; 2<math>\frac{3}{8}</math>" THICK AT WALL; 6<math>\frac{3}{4}</math>" PROJECTION Finish Group</p> <table border="1"> <tr> <th>A</th> <th>B</th> <th>C</th> </tr> <tr> <td>\$48</td> <td>\$56</td> <td>NA</td> </tr> </table>			A	B	C	\$48	\$56	NA
A	B	C						
\$48	\$56	NA						
<p>For 3" Poles <b>DB5046-8P-300</b> 9<math>\frac{3}{4}</math>" L x 2<math>\frac{3}{8}</math>" H 2<math>\frac{3}{8}</math>" THICK; 2<math>\frac{3}{8}</math>" THICK AT WALL; 7<math>\frac{1}{2}</math>" PROJECTION Finish Group</p> <table border="1"> <tr> <th>A</th> <th>B</th> <th>C</th> </tr> <tr> <td>\$68</td> <td>\$74</td> <td>NA</td> </tr> </table>			A	B	C	\$68	\$74	NA
A	B	C						
\$68	\$74	NA						

# ACCESSORIES: Brackets

Standard brackets for 2", 2¼" and 3" diameter poles.

Accent brackets for 2", 2¼" and 3" diameter poles.

*Not Available with Dual Finish System Accent Finishes.*

**Rectangle Bracket\***



p. 59

For 2" or 2¼" Poles  
**DB626-4P-225**  
6¼" L x 3½" H  
1" THICK; 1" THICK AT WALL;  
4" PROJECTION

Finish Group

A	B	C
\$48	\$56	NA

For 3" Poles  
**DB626-4P-300**  
6¼" L x 3½" H  
1" THICK; 1" THICK AT WALL;  
4¼" PROJECTION

Finish Group

A	B	C
\$50	\$58	NA

**Rectangle Bracket\***



p. 59

For 2" or 2¼" Poles  
**DB626-7P-225**  
9⅛" L x 3½" H  
1" THICK; 1" THICK AT WALL;  
7" PROJECTION

Finish Group

A	B	C
\$66	\$74	NA

For 3" Poles  
**DB626-8P-300**  
10" L x 3½" H  
1" THICK; 1" THICK AT WALL;  
7½" PROJECTION

Finish Group

A	B	C
\$74	\$82	NA

**Decal Bracket\***

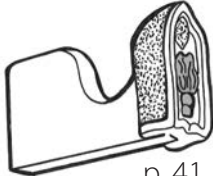

p. 41, 59

When ordering, please include the Decal design number from price list page 44 along with the bracket number.

For 2" or 2¼" Poles  
**DB605X-4P-225**  
6¾" L x 4⅜" H  
2¼" THICK; 1" THICK AT WALL;  
4" PROJECTION

Finish Group

A	B	C
\$130	\$144	\$160

For 3" Poles  
**DB605X-4P-300**  
6¾" L x 4⅜" H  
2¼" THICK; 1" THICK AT WALL;  
4¼" PROJECTION

Finish Group

A	B	C
\$136	\$150	\$166

**Decal Bracket\***

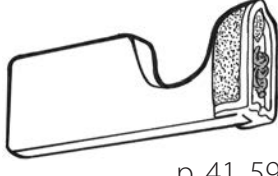

p. 41, 59

When ordering, please include the Decal design number from price list page 44 along with the bracket number.

For 2" or 2¼" Poles  
**DB605X-7P-225**  
10" L x 4⅜" H  
2¼" THICK; 1" THICK AT WALL;  
7" PROJECTION

Finish Group

A	B	C
\$150	\$166	\$180

For 3" Poles  
**DB605X-8P-300**  
10" L x 4⅜" H  
2¼" THICK; 1" THICK AT WALL;  
7½" PROJECTION





Finish Group

A	B	C
\$166	\$184	\$190

\*Indicates bracket has small back plate for use in tight spaces.

# ACCESSORIES: Brackets

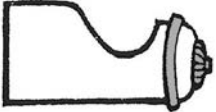
Accent brackets for 2", 2¼" and 3" diameter poles.

<p><b>Opera Bracket*</b></p>  <p>p. 59</p> <p>For 2" or 2¼" Poles <b>DB586X-4P-225</b> 7½"L x 3½"H 4" THICK; 1" THICK AT WALL; 4" PROJECTION Finish Group</p>	<p><b>Opera Bracket*</b></p>  <p>p. 59</p> <p>For 2" or 2¼" Poles <b>DB586X-7P-225</b> 10⅜"L x 3½"H 4" THICK; 1" THICK AT WALL; 7" PROJECTION Finish Group</p>	<p><b>Sonnet Bracket*</b></p>  <p>p. 59</p> <p>For 2" or 2¼" Poles <b>DB587X-4P-225</b> 7¼"L x 3½"H 3" THICK; 1" THICK AT WALL; 4" PROJECTION Finish Group</p>	<p><b>Sonnet Bracket*</b></p>  <p>p. 59</p> <p>For 2" or 2¼" Poles <b>DB587X-7P-225</b> 10⅞"L x 3½"H 3" THICK; 1" THICK AT WALL; 7" PROJECTION Finish Group</p>																								
<table border="1"> <thead> <tr> <th>A</th> <th>B</th> <th>C</th> </tr> </thead> <tbody> <tr> <td>\$94</td> <td>\$106</td> <td>\$122</td> </tr> </tbody> </table>	A	B	C	\$94	\$106	\$122	<table border="1"> <thead> <tr> <th>A</th> <th>B</th> <th>C</th> </tr> </thead> <tbody> <tr> <td>\$112</td> <td>\$124</td> <td>\$140</td> </tr> </tbody> </table>	A	B	C	\$112	\$124	\$140	<table border="1"> <thead> <tr> <th>A</th> <th>B</th> <th>C</th> </tr> </thead> <tbody> <tr> <td>\$94</td> <td>\$106</td> <td>\$122</td> </tr> </tbody> </table>	A	B	C	\$94	\$106	\$122	<table border="1"> <thead> <tr> <th>A</th> <th>B</th> <th>C</th> </tr> </thead> <tbody> <tr> <td>\$112</td> <td>\$124</td> <td>\$140</td> </tr> </tbody> </table>	A	B	C	\$112	\$124	\$140
A	B	C																									
\$94	\$106	\$122																									
A	B	C																									
\$112	\$124	\$140																									
A	B	C																									
\$94	\$106	\$122																									
A	B	C																									
\$112	\$124	\$140																									
<p>For 3" Poles <b>DB586X-4P-300</b> 7½"L x 3½"H 4" THICK; 1" THICK AT WALL; 4¼" PROJECTION Finish Group</p>	<p>For 3" Poles <b>DB586X-8P-300</b> 11¼"L x 3½"H 4" THICK; 1" THICK AT WALL; 7½" PROJECTION Finish Group</p>	<p>For 3" Poles <b>DB587X-4P-300</b> 7¼"L x 3½"H 3" THICK; 1" THICK AT WALL; 4¼" PROJECTION Finish Group</p>	<p>For 3" Poles <b>DB587X-8P-300</b> 11"L x 3½"H 3" THICK; 1" THICK AT WALL; 7½" PROJECTION Finish Group</p>																								
<table border="1"> <thead> <tr> <th>A</th> <th>B</th> <th>C</th> </tr> </thead> <tbody> <tr> <td>\$98</td> <td>\$110</td> <td>\$126</td> </tr> </tbody> </table>	A	B	C	\$98	\$110	\$126	<table border="1"> <thead> <tr> <th>A</th> <th>B</th> <th>C</th> </tr> </thead> <tbody> <tr> <td>\$120</td> <td>\$132</td> <td>\$148</td> </tr> </tbody> </table>	A	B	C	\$120	\$132	\$148	<table border="1"> <thead> <tr> <th>A</th> <th>B</th> <th>C</th> </tr> </thead> <tbody> <tr> <td>\$98</td> <td>\$110</td> <td>\$126</td> </tr> </tbody> </table>	A	B	C	\$98	\$110	\$126	<table border="1"> <thead> <tr> <th>A</th> <th>B</th> <th>C</th> </tr> </thead> <tbody> <tr> <td>\$120</td> <td>\$132</td> <td>\$148</td> </tr> </tbody> </table>	A	B	C	\$120	\$132	\$148
A	B	C																									
\$98	\$110	\$126																									
A	B	C																									
\$120	\$132	\$148																									
A	B	C																									
\$98	\$110	\$126																									
A	B	C																									
\$120	\$132	\$148																									

\*Indicates bracket has small back plate for use in tight spaces.

Decorative brackets for 2" and 2¼" diameter poles.

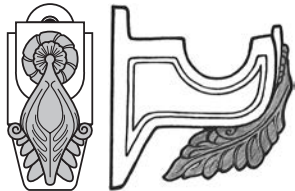
 <p>p. 60</p>	<p><b>Doublet Bracket</b></p> <p>For 2" or 2¼" Poles <b>DB028-5P-225</b> 7½"L x 7½"H 3½" THICK; 4½" PROJECTION Finish Group</p> <table border="1"> <thead> <tr> <th>A</th> <th>B</th> <th>C</th> </tr> </thead> <tbody> <tr> <td>\$108</td> <td>\$118</td> <td>\$130</td> </tr> </tbody> </table>	A	B	C	\$108	\$118	\$130
A	B	C					
\$108	\$118	\$130					

# ACCESSORIES: Brackets

Decorative brackets for 1 3/8", 2", 2 1/4" and 3" diameter poles.

## Inlay Bracket

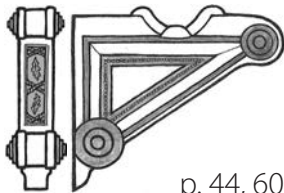

p. 44, 60

Please include the Inlay design number from price list page 40 along with the bracket number.

For 2" or 2 1/4" Poles  
**DB555X-5P-225**

9 1/4" L x 8 1/4" H  
3 1/2" THICK; 4 7/8" PROJECTION

*Includes Adaptor Cradle  
for 2" or 2 1/4" Poles*

Finish Group

A	B	C
\$186	\$196	\$218

## Inlay Bracket

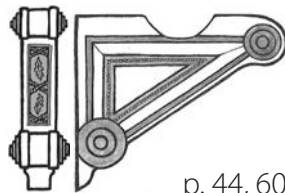

p. 44, 60

Please include the Inlay design number from price list page 40 along with the bracket number.

For 3" Poles  
**DB555X-5P-300**

9 1/4" L x 8 1/4" H  
3 1/2" THICK; 4 7/8" PROJECTION

Finish Group

A	B	C
\$186	\$196	\$218

## Prose Bracket

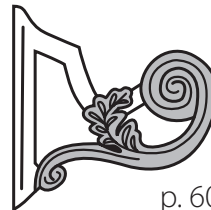

p. 60

For 1 3/8" Poles  
**DB056-4P-138**

5 7/8" L x 4 3/4" H  
1 1/4" THICK; 3 1/2" PROJECTION

Finish Group

A	B	C
\$44	\$50	\$58

For 2" or 2 1/4" Poles  
**DB056-4P-225**

7 1/2" L x 8 1/8" H  
1 1/2" THICK; 4" PROJECTION

Finish Group

A	B	C
\$60	\$66	\$76

## Prose Bracket



p. 60

For 1 3/8" Poles  
**DB056-6P-138**

7 3/4" L x 7 3/4" H  
1 1/4" THICK; 5 3/8" PROJECTION

Finish Group

A	B	C
\$64	\$68	\$78

For 2" or 2 1/4" Poles  
**DB056-7P-225**

10 1/2" L x 6 3/8" H  
1 1/2" THICK; 7 1/4" PROJECTION

Finish Group

A	B	C
\$70	\$76	\$86

## Poetry Bracket

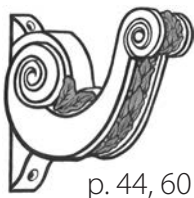

p. 44, 60

For 2" or 2 1/4" Poles  
**DB057-5P-225**

8 1/2" L x 6 3/4" H  
2 1/8" THICK; 4 5/8" PROJECTION

Finish Group

A	B	C
\$76	\$84	\$96

## Poetry Bracket

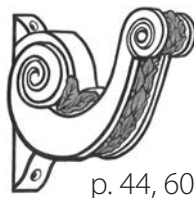

p. 44, 60

For 2" or 2 1/4" Poles  
**DB057-7P-225**

10 3/4" L x 7 3/8" H  
2 1/8" THICK; 7" PROJECTION

Finish Group

A	B	C
\$96	\$108	\$124

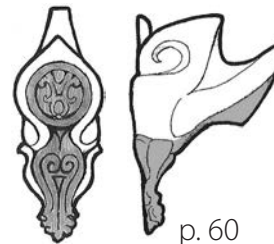

p. 60

## Rhythm Bracket

For 2" or 2 1/4" Poles  
**DB117-5P-225**

7" L x 10" H  
5" THICK; 4 3/4" PROJECTION

Finish Group

A	B	C
\$118	\$128	\$146

# ACCESSORIES: Sockets & End Caps

## Additional Wood Pole Accessories

### Laurel Wreath Socket Bracket

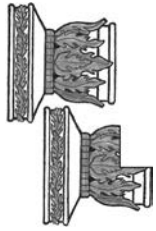

p. 61

For 2" or 2 1/4" Poles  
**DB535-225**  
3 7/8" L x 4" H  
SOLD AS PAIR

#### Finish Group

A	B	C
\$176	\$188	\$204

For 3" Poles  
**DB535-300**  
4 5/8" L x 5 1/8" H  
SOLD AS PAIR

#### Finish Group

A	B	C
\$184	\$198	\$212

### Standard Socket Bracket

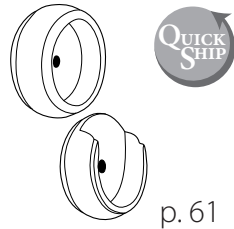

p. 61

For 1 3/8" Poles  
**DB5051-138**  
7/8" L x 1 3/4" H  
SOLD AS PAIR

#### Finish Group

A	B	C
\$30	\$32	NA

For 2" Poles  
**DB5051-200**  
1 1/8" L x 2 5/8" H  
SOLD AS PAIR

#### Finish Group

A	B	C
\$52	\$54	NA

For 2 1/4" Poles  
**DB5051-225**  
1 1/8" L x 2 3/4" H  
SOLD AS PAIR

#### Finish Group

A	B	C
\$52	\$54	NA

### Swivel Elbow

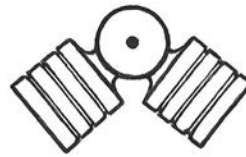

p. 61

For 1 3/8" Poles  
**DB5050-138**  
5" L TO JOINT x 1 5/8" DIAMETER

#### Finish Group

A	B	C
\$52	\$66	NA

For 2" Poles  
**DB5050-200**  
5 1/8" L TO JOINT x 2 5/8" DIAMETER

#### Finish Group

A	B	C
\$68	\$76	NA

For 2 1/4" Poles  
**DB5050-225**  
5 1/8" L TO JOINT x 2 7/8" DIAMETER

#### Finish Group

A	B	C
\$68	\$76	NA

### End Cap



p. 61

For 1 3/8" Poles  
**DE5052-138**  
7/8" L x 1 3/4" H

#### Finish Group

A	B	C
\$28	\$30	NA

For 2" Poles  
**DE5052-200**  
1 1/8" L x 2 3/4" H

#### Finish Group

A	B	C
\$52	\$56	NA

For 2 1/4" Poles  
**DE5052-225**  
1 1/4" L x 3" H

#### Finish Group

A	B	C
\$52	\$56	NA

For 3" Poles  
**DE5052-300**  
1 1/4" L x 3 1/4" H

#### Finish Group

A	B	C
\$78	\$84	NA



Available for Quick Ship. See pages 6-9.

# ACCESSORIES: Batons

## Iron and Wood Batons

Batons Are Not Available with Dual Finish System Accent Finishes. Additional Clips Available for \$2.00 each, Item #DM1022

### Iron Round Baton

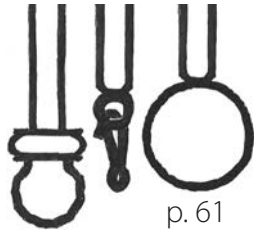

p. 61

Please Specify Ring or Clip  
**DM1016**

1/2" DIAMETER : 5/8" AFTER 73"

Custom Lengths Available

Length	Finish Group	
	A	B
12"-24"	\$52	\$58
25"-48"	\$62	\$68
49"-72"	\$80	\$88
73"-84"	\$100	\$110
85"-108"	\$124	\$138

### Iron Round Baton with Wood Handle



p. 61

Please Specify Ring or Clip  
**DM1020**

1/2" DIAMETER : 5/8" AFTER 73"

Custom Lengths Available

Length	Finish Group	
	A	B
12"-24"	\$52	\$58
25"-48"	\$62	\$68
49"-72"	\$80	\$88
73"-84"	\$100	\$110
85"-108"	\$124	\$138

### Wood Round Baton with Wood Handle

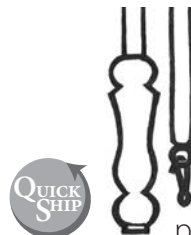

p. 61

Clip Only  
**DM5053**

1/2" DIAMETER  
38" LONG

Finish Group		
A	B	C
\$42	\$50	NA

### Wood Round Baton with Wood Handle



p. 61

Clip Only  
**DM5071**

5/8" DIAMETER  
38" LONG



Finish Group		
A	B	C
\$60	\$66	NA



Available for Quick Ship. See pages 6-9.

# ACCESSORIES: Wood Rings

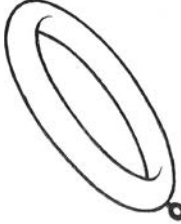
Wood rings for 1 3/8", 2", 2 1/4" and 3" diameter poles.

**Smooth Ring**   p. 62

For 1 3/8" Poles  
**DG5047-138**  
1/2" THICK  
1 3/4" INNER DIAMETER  
2 3/4" OUTER DIAMETER  
Finish Group



A	B	C
\$10	\$12	NA

For 2" or 2 1/4" Poles  
**DG5047-225**  
1/2" THICK  
2 5/8" INNER DIAMETER  
3 5/8" OUTER DIAMETER  
Finish Group

A	B	C
\$12	\$14	NA

For 3" Poles  
**DG5047-300**  
7/8" THICK  
3 3/8" INNER DIAMETER  
5 1/8" OUTER DIAMETER  
Finish Group

A	B	C
\$18	\$20	NA

**Fluted Ring**   p. 62

For 1 3/8" Poles  
**DG5049-138**  
5/8" THICK  
1 3/4" INNER DIAMETER  
3" OUTER DIAMETER  
Finish Group

A	B	C
\$10	\$12	\$18

For 2" or 2 1/4" Poles  
**DG5049-225**  
3/4" THICK  
2 3/4" INNER DIAMETER  
4 1/4" OUTER DIAMETER  
Finish Group

A	B	C
\$12	\$14	\$28

For 3" Poles  
**DG5049-300**  
7/8" THICK  
3 3/8" INNER DIAMETER  
5 1/8" OUTER DIAMETER  
Finish Group

A	B	C
\$18	\$20	\$34

**Coronet Ring**  p. 62

For 2" or 2 1/4" Poles  
**DG544-225**  
1/2" THICK  
2 5/8" INNER DIAMETER  
4" OUTER DIAMETER  
Finish Group

A	B	C
\$30	\$32	\$44

For 3" Poles  
**DG544-300**  
5/8" THICK  
3 3/8" INNER DIAMETER  
5 1/8" OUTER DIAMETER  
Finish Group

A	B	C
\$32	\$34	\$46

*Coordinates with Autumn & Opera Inlay items.*

**Paisley Ring**  p. 62

For 2" or 2 1/4" Poles  
**DG062-225**  
3/4" THICK  
2 5/8" INNER DIAMETER  
4 1/4" OUTER DIAMETER  
Finish Group

A	B	C
\$32	\$34	\$46

For 3" Poles  
**DG062-300**  
7/8" THICK  
3 1/2" INNER DIAMETER  
5 1/4" OUTER DIAMETER  
Finish Group

A	B	C
\$38	\$40	\$52

*Coordinates with Paisley Inlay items.*

*Not Available with Dual Finish System Accent Finishes.*



Available for Quick Ship. See pages 6-9.



# ACCESSORIES: Wood Rings

Wood rings for 1 3/8", 2", 2 1/4" and 3" diameter poles.

## Pinwheel Ring



p. 62

For 2" or 2 1/4" Poles  
**DG063-225**

3/4" THICK  
2 3/4" INNER DIAMETER  
4 5/8" OUTER DIAMETER

Finish Group

A	B	C
\$26	\$28	\$40

For 3" Poles  
**DG063-300**

3/4" THICK  
3 1/4" INNER DIAMETER  
5 1/4" OUTER DIAMETER

Finish Group

A	B	C
\$28	\$30	\$42

*Coordinates with  
Pinwheel Inlay items.*

## Regalia Ring



p. 62

For 2" or 2 1/4" Poles  
**DG546-225**

1 1/8" THICK  
2 1/2" INNER DIAMETER  
4 1/4" OUTER DIAMETER

Finish Group

A	B	C
\$28	\$30	\$42

For 3" Poles  
**DG546-300**

1 1/8" THICK  
3 3/8" INNER DIAMETER  
5 1/8" OUTER DIAMETER

Finish Group

A	B	C
\$34	\$38	\$50

*Coordinates with Harvest  
& Pinwheel Inlay items.*

## Soprano Ring



p. 62

For 1 3/8" Poles  
**DG059-138**

1/2" THICK  
1 7/8" INNER DIAMETER  
3" OUTER DIAMETER

Finish Group

A	B	C
\$22	\$24	\$36

For 2" or 2 1/4" Poles  
**DG059-225**

5/8" THICK  
2 5/8" INNER DIAMETER  
4 3/8" OUTER DIAMETER

Finish Group

A	B	C
\$24	\$26	\$38

For 3" Poles  
**DG059-300**

5/8" THICK  
3 3/8" INNER DIAMETER  
5" OUTER DIAMETER

Finish Group

A	B	C
\$26	\$28	\$40

*Coordinates with Autumn,  
Garland, & Opera Inlay items.*

## Tiara Ring



p. 62

For 2" or 2 1/4" Poles  
**DG567-225**

5/8" THICK  
3" INNER DIAMETER  
4 1/4" OUTER DIAMETER

Finish Group

A	B	C
\$30	\$32	\$44

For 3" Poles  
**DG567-300**

5/8" THICK  
3 1/2" INNER DIAMETER  
5" OUTER DIAMETER

Finish Group

A	B	C
\$32	\$34	\$46

*Coordinates with  
Cameo Inlay items.*

# ACCESSORIES: Iron Rings

Iron rings for 1 3/8", 2", 2 1/4" and 3" diameter wood poles.

*Not Available with Dual Finish System Accent Finishes.*

**Round Iron Ring**

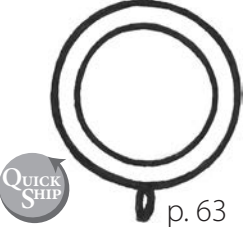

QUICK SHIP p. 63

For 1 3/8" Poles  
**DG350-138**  
1/4" THICK  
2" INNER DIAMETER  
2 1/2" OUTER DIAMETER  
Finish Group

A	B	C
\$6	\$8	NA

For 2" Poles  
**DG350-200**  
1/4" THICK  
2 1/2" INNER DIAMETER  
3" OUTER DIAMETER  
Finish Group

A	B	C
\$8	\$10	NA

2 1/4" Poles  
**DG350-225**  
1/4" THICK  
3" INNER DIAMETER  
3 1/2" OUTER DIAMETER  
Finish Group

A	B	C
\$8	\$10	NA

For 3" Poles  
**DG350-300**  
1/4" THICK  
3 1/2" INNER DIAMETER  
4" OUTER DIAMETER  
Finish Group

A	B	C
\$10	\$12	NA

**Hammered Iron Ring**



p. 63

For 1 3/8" Poles  
**DG356-138**  
1/4" THICK  
2" INNER DIAMETER  
2 1/2" OUTER DIAMETER  
Finish Group

A	B	C
\$8	\$10	NA

For 2" Poles  
**DG356-200**  
1/4" THICK  
2 1/2" INNER DIAMETER  
3" OUTER DIAMETER  
Finish Group

A	B	C
\$10	\$12	NA

2 1/4" Poles  
**DG356-225**  
1/4" THICK  
3" INNER DIAMETER  
3 1/2" OUTER DIAMETER  
Finish Group

A	B	C
\$10	\$12	NA

For 3" Poles  
**DG356-300**  
1/4" THICK  
3 1/2" INNER DIAMETER  
4" OUTER DIAMETER  
Finish Group

A	B	C
\$16	\$18	NA

**Twisted Iron Ring**

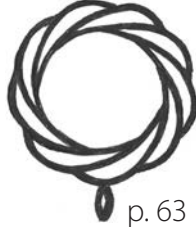

p. 63

For 1 3/8" Poles  
**DG351-138**  
1/4" THICK  
2" INNER DIAMETER  
2 1/2" OUTER DIAMETER  
Finish Group

A	B	C
\$10	\$12	NA

For 2" Poles  
**DG351-200**  
1/4" THICK  
2 1/2" INNER DIAMETER  
3" OUTER DIAMETER  
Finish Group

A	B	C
\$12	\$14	NA

2 1/4" Poles  
**DG351-225**  
1/4" THICK  
3" INNER DIAMETER  
3 1/2" OUTER DIAMETER  
Finish Group

A	B	C
\$12	\$14	NA



For 3" Poles  
**DG351-300**  
1/4" THICK  
3 1/2" INNER DIAMETER  
4" OUTER DIAMETER  
Finish Group

A	B	C
\$18	\$20	NA

# ACCESSORIES: Iron Brackets

Iron end brackets for 1 3/8", 2", 2 1/4" and 3" diameter wood poles.

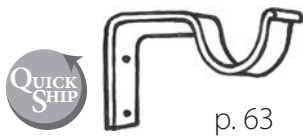
*Not Available with Dual Finish System Accent Finishes.*

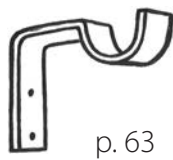
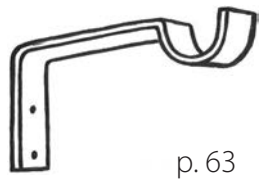



Iron End Bracket with Lip				Iron End Bracket with Lip				Iron End Bracket				Iron End Bracket			
 <p>QUICK SHIP p. 63</p>				 <p>QUICK SHIP p. 63</p>				 <p>p. 63</p>				 <p>p. 63</p>			
For 1 3/8" Poles				For 1 3/8" Poles				For 1 3/8" Poles				For 1 3/8" Poles			
<b>DB1028-RND-3P-138</b>				<b>DB1028-RND-6P-138</b>				<b>DB1040-RND-3P-138</b>				<b>DB1040-RND-6P-138</b>			
3 1/4" H X 1" W				3 1/4" H X 1" W				3 1/4" H X 1" W				3 1/4" H X 1" W			
3" PROJECTION				6" PROJECTION				3" PROJECTION				6" PROJECTION			
Finish Group				Finish Group				Finish Group				Finish Group			
A	B	C		A	B	C		A	B	C		A	B	C	
\$26	\$30	NA		\$36	\$40	NA		\$26	\$30	NA		\$36	\$40	NA	
For 2" Poles				For 2" Poles				For 2" Poles				For 2" Poles			
<b>DB1028-RND-4P-200</b>				<b>DB1028-RND-6P-200</b>				<b>DB1040-RND-4P-200</b>				<b>DB1040-RND-6P-200</b>			
4" H X 1" W				4" H X 1" W				4" H X 1" W				4" H X 1" W			
4" PROJECTION				6" PROJECTION				4" PROJECTION				6" PROJECTION			
Finish Group				Finish Group				Finish Group				Finish Group			
A	B	C		A	B	C		A	B	C		A	B	C	
\$28	\$32	NA		\$38	\$42	NA		\$28	\$32	NA		\$38	\$42	NA	
For 2 1/4" Poles				For 2 1/4" Poles				For 2 1/4" Poles				For 2 1/4" Poles			
<b>DB1028-RND-4P-225</b>				<b>DB1028-RND-6P-225</b>				<b>DB1040-RND-4P-225</b>				<b>DB1040-RND-6P-225</b>			
4" H X 1" W				4" H X 1" W				4" H X 1" W				4" H X 1" W			
4" PROJECTION				6" PROJECTION				4" PROJECTION				6" PROJECTION			
Finish Group				Finish Group				Finish Group				Finish Group			
A	B	C		A	B	C		A	B	C		A	B	C	
\$28	\$32	NA		\$38	\$42	NA		\$28	\$32	NA		\$38	\$42	NA	
For 3" Poles				For 3" Poles				For 3" Poles				For 3" Poles			
<b>DB1028-RND-5P-300</b>				<b>DB1028-RND-7P-300</b>				<b>DB1040-RND-5P-300</b>				<b>DB1040-RND-7P-300</b>			
5" H X 1" W				5" H X 1" W				5" H X 1" W				5" H X 1" W			
5" PROJECTION				7" PROJECTION				5" PROJECTION				7" PROJECTION			
Finish Group				Finish Group				Finish Group				Finish Group			
A	B	C		A	B	C		A	B	C		A	B	C	
\$32	\$36	NA		\$40	\$44	NA		\$32	\$36	NA		\$40	\$44	NA	

Available for Quick Ship. See pages 6-9.

# ACCESSORIES: Iron Brackets

Iron brackets for 1 $\frac{3}{8}$ " , 2" , 2 $\frac{1}{4}$ " and 3" diameter wood poles.



*Not Available with Dual Finish System Accent Finishes.*

Iron Support Bracket with Lip			Iron Support Bracket with Lip			Double Iron Support Bracket with Lip			Double Iron Support Bracket		
 p. 63 For 1 $\frac{3}{8}$ " Poles <b>DB1028HP-RND-3P-138</b> 1 $\frac{5}{8}$ "H x 3"W 3" PROJECTION BACKPLATE: 1"H x 3"W Finish Group			 p. 63 For 1 $\frac{3}{8}$ " Poles <b>DB1028HP-RND-6P-138</b> 1 $\frac{5}{8}$ "H x 3"W 6" PROJECTION BACKPLATE: 1"H x 3"W Finish Group			 p. 63 For 1 $\frac{3}{8}$ " Poles <b>DB1024DBWS-RND-138</b> 4"H x 1"W 3" / 6" PROJECTIONS Finish Group			 p. 63 For 1 $\frac{3}{8}$ " Poles <b>DB1040DBWS-RND-138</b> 4"H x 1"W 3" / 6" PROJECTIONS Finish Group		
A	B	C	A	B	C	A	B	C	A	B	C
\$26	\$30	NA	\$36	\$40	NA	\$46	\$50	NA	\$38	\$42	NA
For 2" Poles <b>DB1028HP-RND-4P-200</b> 2 $\frac{1}{4}$ "H x 3"W 4" PROJECTION BACKPLATE: 1"H x 3"W Finish Group			For 2" Poles <b>DB1028HP-RND-6P-200</b> 2 $\frac{1}{4}$ "H x 3"W 6" PROJECTION BACKPLATE: 1"H x 3"W Finish Group			For 2" Poles <b>DB1024DBWS-RND-200</b> 4"H x 1"W 4" / 8" PROJECTIONS Finish Group			For 2" Poles <b>DB1040DBWS-RND-200</b> 4"H x 1"W 4" / 8" PROJECTIONS Finish Group		
A	B	C	A	B	C	A	B	C	A	B	C
\$28	\$32	NA	\$38	\$42	NA	\$48	\$52	NA	\$40	\$44	NA
2 $\frac{1}{4}$ " Poles <b>DB1028HP-RND-4P-225</b> 2 $\frac{1}{2}$ "H x 3"W 4" PROJECTION BACKPLATE: 1"H x 3"W Finish Group			2 $\frac{1}{4}$ " Poles <b>DB1028HP-RND-6P-225</b> 2 $\frac{1}{2}$ "H x 3"W 6" PROJECTION BACKPLATE: 1"H x 3"W Finish Group			2 $\frac{1}{4}$ " Poles <b>DB1024DBWS-RND-225</b> 4"H x 1"W 4" / 8" PROJECTIONS Finish Group			2 $\frac{1}{4}$ " Poles <b>DB1040DBWS-RND-225</b> 4"H x 1"W 4" / 8" PROJECTIONS Finish Group		
A	B	C	A	B	C	A	B	C	A	B	C
\$28	\$32	NA	\$38	\$42	NA	\$48	\$52	NA	\$40	\$44	NA
For 3" Poles <b>DB1028HP-RND-5P-300</b> 3 $\frac{1}{4}$ "H x 3"W 5" PROJECTION BACKPLATE: 1"H x 3"W Finish Group			For 3" Poles <b>DB1028HP-RND-7P-300</b> 3 $\frac{1}{4}$ "H x 3"W 7" PROJECTION BACKPLATE: 1"H x 3"W Finish Group			For 3" Poles <b>DB1024DBWS-RND-300</b> 4"H x 1"W 5" / 10" PROJECTIONS Finish Group			For 3" Poles <b>DB1040DBWS-RND-300</b> 4"H x 1"W 5" / 10" PROJECTIONS Finish Group		
A	B	C	A	B	C	A	B	C	A	B	C
\$32	\$36	NA	\$40	\$44	NA	\$50	\$54	NA	\$42	\$46	NA

# ACCESSORIES: Iron Brackets

Iron brackets for 1 3/8", 2", 2 1/4" and 3" diameter wood poles.

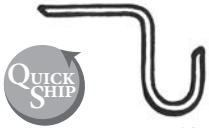
*Not Available with Dual Finish System Accent Finishes.*

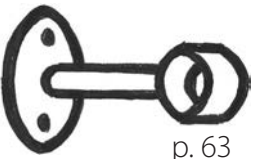
Iron Ceiling Bracket				Double Iron Ceiling Bracket				Socket Bracket Pair				Eyelet Bracket			
 <p>QUICK SHIP</p> <p>p. 63</p> <p>For 1 3/8" Poles <b>DB1035-RND-138</b> 3"H x 1"W 3" PROJECTION 3" DROP</p> <p>Finish Group</p>				 <p>p. 63</p> <p>For 1 3/8" Poles <b>DB1036-RND-138</b> 3"H x 1"W 3" / 6" PROJECTION 3" DROP</p> <p>Finish Group</p>				 <p>p. 63</p> <p>For 1 3/8" Poles <b>DB324-RND-138</b> 1"L x 2"H SOLD AS PAIR</p> <p>Finish Group</p>				 <p>p. 63</p> <p>For 1 3/8" Poles <b>DB1010-RND-138</b> 2"H x 2"W 3" PROJECTION</p> <p>Finish Group</p>			
\$26	\$30	NA	\$36	\$40	NA	\$36	\$40	NA	\$38	\$42	NA				
<p>For 2" Poles <b>DB1035-RND-200</b> 4"H x 1"W 3" PROJECTION 4" DROP</p> <p>Finish Group</p>				<p>For 2" Poles <b>DB1036-RND-200</b> 4"H x 1"W 4" / 8" PROJECTION 4" DROP</p> <p>Finish Group</p>				<p>For 2" Poles <b>DB324-RND-200</b> 1"L x 2 1/2"H SOLD AS PAIR</p> <p>Finish Group</p>				<p>For 2" Poles <b>DB1010-RND-200</b> 2"H x 2"W 4" PROJECTION</p> <p>Finish Group</p>			
\$28	\$32	NA	\$38	\$42	NA	\$38	\$42	NA	\$40	\$44	NA				
<p>2 1/4" Poles <b>DB1035-RND-225</b> 4"H x 1"W 3" PROJECTION 4" DROP</p> <p>Finish Group</p>				<p>2 1/4" Poles <b>DB1036-RND-225</b> 4"H x 1"W 4" / 8" PROJECTION 4" DROP</p> <p>Finish Group</p>				<p>2 1/4" Poles <b>DB324-RND-225</b> 1"L x 2 3/4"H SOLD AS PAIR</p> <p>Finish Group</p>				<p>2 1/4" Poles <b>DB1010-RND-225</b> 2"H x 2"W 4" PROJECTION</p> <p>Finish Group</p>			
\$28	\$32	NA	\$38	\$42	NA	\$38	\$42	NA	\$40	\$44	NA				
<p>For 3" Poles <b>DB1035-RND-300</b> 5"H x 1"W 5" PROJECTION 5" DROP</p> <p>Finish Group</p>				<p>For 3" Poles <b>DB1036-RND-300</b> 5"H x 1"W 5" / 10" PROJECTION 5" DROP</p> <p>Finish Group</p>				<p>For 3" Poles <b>DB324-RND-300</b> 1"L x 3 1/4"H SOLD AS PAIR</p> <p>Finish Group</p>				<p>For 3" Poles <b>DB1010-RND-300</b> 2"H x 2"W 5" PROJECTION</p> <p>Finish Group</p>			
\$32	\$36	NA	\$40	\$44	NA	\$40	\$44	NA	\$42	\$46	NA				

Available for Quick Ship. See pgs 6-9.

# ACCESSORIES: Holdbacks

Holdback options for Finials and Rod-Enders.

- Choose any Finial (pages 12-15) or Rod-Enders (pages 18-19).
- Iron U-Bend Holdbacks are available with a 3½" projection.
- Iron Post Holdbacks are available with 3", 4" or 6½" projections.
- Wood Post and Pedestal Holdbacks are available with 2½", 4", or 6" projections with a smooth or fluted 2" diameter pole. Custom projections up to 12" are available at no additional charge. Please call for a quote for projections over 12".
- Only Pedestal Holdbacks are available with Dual Finish System Accent Finishes. All other Holdbacks are finished in the Finial or Rod-Enders' Décor Finish.
- Some Rod-Enders are available flush mount for use as medallions or rosettes. Please see Rod-Enders (pages 18-19) for details.
- Holdbacks are shipped assembled.
- Iron Post and Wood Post Holdbacks include a mounting plate.



## Iron U-Bend Holdback

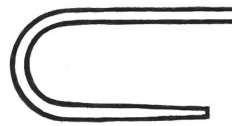

p. 64

8½" LONG

½" DIAMETER

3½" Projection  
**DM1087**

Finish Group

A	B	C
\$24	\$28	NA

## Iron Post Holdback

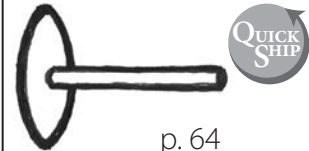

p. 64

BACKPLATE: 3⅛" DIAMETER

3" Projection  
**DM1088-300**

4" Projection  
**DM1088-400**

6½" Projection  
**DM1088-650**

Finish Group

A	B	C
\$20	\$22	NA

## Smooth Wood Post Holdback



p. 64

2" DIAMETER POLE

2½" Projection  
**DM1090-SM-250**

4" Projection  
**DM1090-SM-400**

6" Projection  
**DM1090-SM-600**

Custom Projection  
**DM1090-SM-CUST**

Finish Group

A	B	C
\$24	\$28	NA

## Fluted Wood Post Holdback



p. 64

2" DIAMETER POLE

2½" Projection  
**DM1090-FL-250**

4" Projection  
**DM1090-FL-400**

6" Projection  
**DM1090-FL-600**

Custom Projection  
**DM1090-FL-CUST**

Finish Group

A	B	C
\$24	\$28	NA

## Pedestal Holdback with Smooth Wood

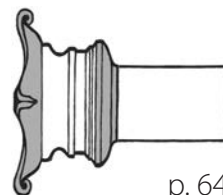

p. 64

2" DIAMETER POLE

2½" L x 4½" H BASE

2½" Projection (base)  
**DM111-250**

4" Projection  
**DM111-SM-400**

6" Projection  
**DM111-SM-600**

Custom Projection  
**DM111-SM-CUST**

Finish Group

A	B	C
\$46	\$54	\$62

## Pedestal Holdback with Fluted Wood

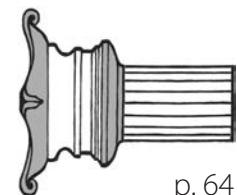

p. 64

2" DIAMETER POLE

2½" L x 4½" H BASE

2½" Projection (base)  
**DM111-250**

4" Projection  
**DM111-FL-400**

6" Projection  
**DM111-FL-600**

Custom Projection  
**DM111-FL-CUST**

Finish Group

A	B	C
\$46	\$54	\$62



# ELEGANT ADORNMENTS

Centerpieces, Stair Newels and Medallions

**CENTERPIECES** are beautiful and elegant "sleeves" designed to simply slide over 2" and 2¼" poles.

## Hallmark Centerpiece



p. 65

9" L x 4⅛" H

For 2" Poles

**DM604X-2**

For 2¼" Poles

**DM604-2**

Finish Group

A	B	C
\$148	\$176	\$202

## Signet Centerpiece

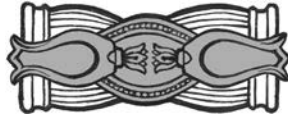

p. 65

9" L x 4⅞" H

For 2" Poles

**DM603X-2**

For 2¼" Poles

**DM603-2**

Finish Group

A	B	C
\$140	\$166	\$196

**STAIR NEWELS** Add coordinating accents using SwissCrystal-On-Wood Finials.



Elegant crystals have graced the stair newel posts of fine homes for centuries. Create your own Crystal Stair Newel Finials to coordinate with your drapery hardware by combining any SwissCrystal with any flush mountable SwissCrystal Base. Please see the Base Guide on page 25 for available bases.

## MEDALLIONS

- Combine the petite Beth Medallion with the larger Elizabeth Medallion to create a stunningly unique drapery design.
- Medallions are available as flush mount or as holdbacks when combined with Iron Post, Iron U-Bend, Wood Post or Pedestal Holdbacks.
- Medallions are shipped assembled with their holdback (if applicable).
- Medallions include a mounting plate.

### Amanda Medallion

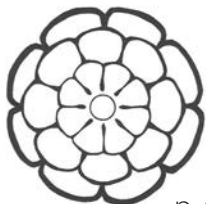

p. 66

**DY001**

1½" L x 5¾" H

Finish Group

A	B	C
\$58	\$60	NA

### Beth Medallion

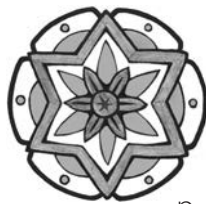

p. 66

**DM125**

1½" L x 4" H

Finish Group

A	B	C
\$44	\$54	\$66

### Elizabeth Medallion

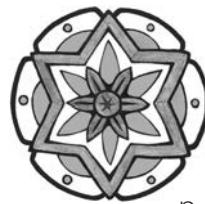

p. 66

**DM002**

1⅞" L x 5¾" H

Finish Group

A	B	C
\$54	\$64	\$76

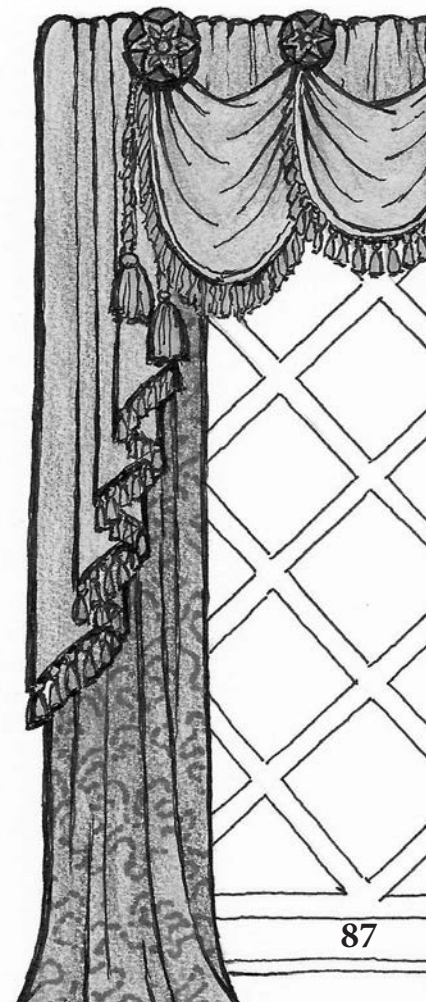

# SELLING TOOLS

## Wall Display Set

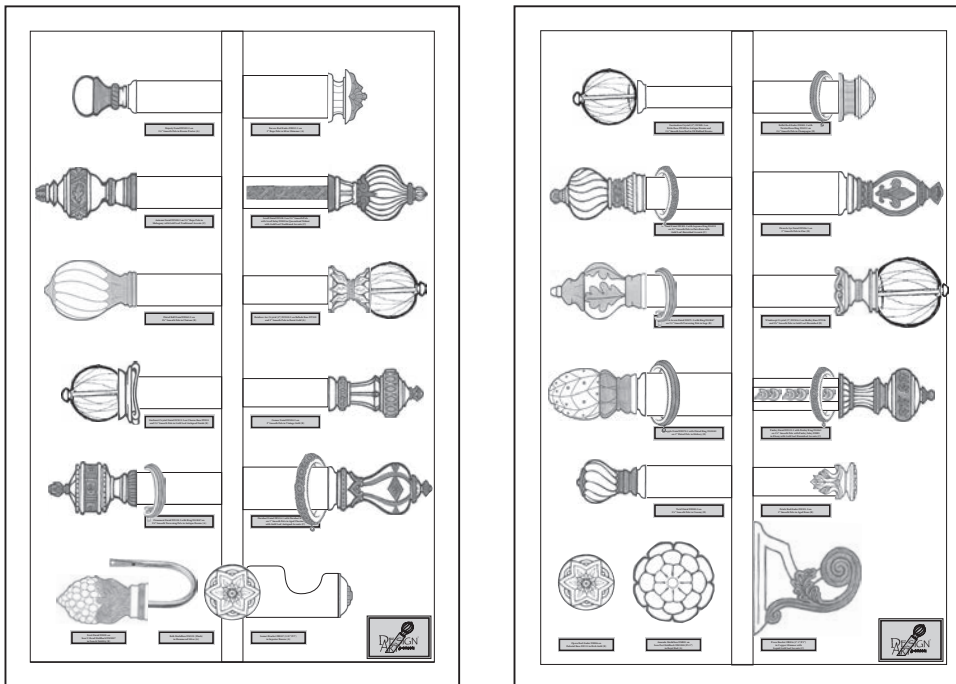

p. 81

**DS100** - 32"W X 48"H EACH

### Board One (Left) Includes:

- DF102-2** Majesty Finial on 2¼" Smooth Pole in Bronze Pewter (A)
- DF500-2** Autumn Finial on 2¼" Rope Pole in Mahogany with Gold Leaf-Traditional Accents (C)
- DF069-2** Fluted Ball Finial on 2¼" Smooth Pole in Chateau (B)
- DC813-2** Starburst SwissCrystal Finial with **DY055** Chorus Base on 2¼" Smooth Pole in Gold Leaf-Antiqued (B)
- DF520-2** Ornament Finial with **DGT5047-225** Smooth Traversing Ring on 2¼" Smooth Traversing Pole in Antique Bronze (A)
- DE052-3** Encore Rod-End on 3" Smooth Pole in Silver Shimmer (A)
- DF530-2** Scroll Finial on 2¼" Scroll Inlay Pole in Queensland Walnut with Gold Leaf-Traditional Accents (C)
- DC810-2** Rainbow Arc SwissCrystal Finial with **DY510** Ballade Base on 2" Smooth Pole in Burnt Gold (A)
- DF504-2** Cameo Finial on 2" Smooth Pole in Vintage Gold (B)
- DF504-3** Pinwheel Finial with **DG063-300** Pinwheel Ring on 3" Smooth Pole in Aged Chestnut with Gold Leaf-Antiqued Accents (C)
- DF095** Fruit Finial on Iron U-Bend Holdback in French Nobility (B)
- DM125** Beth Medallion in Hammered Silver (A)
- DB587X** Sonnet Bracket (P4") in Superior Bronze (A)

### Board Two (Right) Includes:

- DC805** Fascination SwissCrystal Finial with Standard Base in Antique Bronze on 1¼" Iron Rod in Oil Rubbed Bronze (D)
- DF509-2** Garland Finial with **DG059-225** Soprano Ring on 2¼" Smooth Pole in Paris Rain with Gold Leaf-Burnished Accents (C)
- DF071-2** Oak and Acorn Finial with **DGT5047-225** Smooth Traversing Ring on 2¼" Smooth Traversing Pole in Sage (B)
- DF070-3** Pineapple Finial with **DG5049-300** Fluted Ring on 3" Fluted Pole in Hickory (B)
- DF089-2** Twirl Finial on 2¼" Smooth Pole in Creamy (B)
- DE049-2** Ballet Rod-End with **DG351-225** Twisted Iron Ring on 2¼" Smooth Pole in Champagne (B)
- DF506-3** Fleur de Lys Finial on 3" Smooth Pole in Zinc (B)
- DC816-2** Windswept SwissCrystal Finial with **DY526** Medley Base on 2¼" Smooth Pole in Gold Leaf-Burnished (B)
- DF522-2** Paisley Finial with **DG062-225** Paisley Ring on 2¼" Paisley Inlay Pole in Ebony with Gold Leaf-Burnished Accents (C)
- DE525-2** Petals Sleeve Rod-End on 2" Smooth Pole in Aged Brass (B)
- DE086** Opera Rod-End on Pedestal Holdback Base in Rich Gold (B)
- DY001** Amanda Medallion on Iron Post Projection in Royal Red (A)
- DB056** Prose Bracket (P4") in Copper Glimmer with Liquid Gold Leaf Accents (C)

**Price per Set:** \$1,000 Net



# SELLING TOOLS

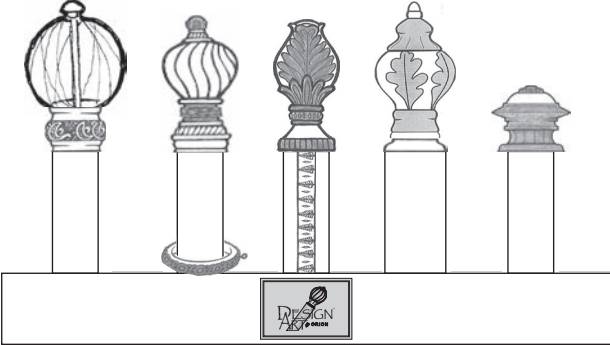

p. 81

### TableTopper

**DS200** - 30"W x 17"H x 4"D

Includes:

**DC812-2** Spring Flowers SwissCrystal Finial with **DY072** Antique Base on 2¼" Smooth Pole in Royal Red (A)

**DF509-2** Garland Finial with **DG059-225** Soprano Ring on 2¼" Smooth Pole French Nobility (B)

**DF516-2** Opera Finial on 2¼" Opera Inlay Pole in Queensland Walnut with Gold Leaf-Traditional Accents (C)

**DF071-3** Oak and Acorn Finial on 3" Smooth Pole in Sage (B)

**DE048-2** Cotillion Rod-Enders on 2¼" Smooth Traversing Pole in Rich Gold (B)

**Price:** \$200 Net

### ShowOffs

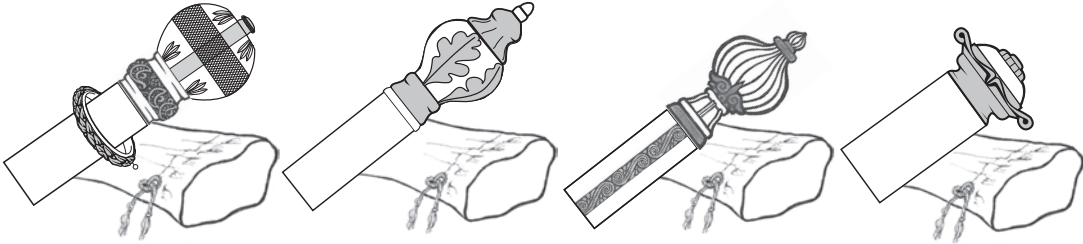

p. 82

Each ShowOff comes with a soft velvet protective sleeve with gold ties (7"w x 17½"L). Buy them individually or in a set of 4.

Item	Price	Description (Shown Left to Right)
<b>DS301</b>	\$70 Net	<b>DC803-2</b> Diamonds SwissCrystal Finial with <b>DY072</b> Antique Base & <b>DG059-225</b> Soprano Ring on 2¼" Smooth Pole in Rich Gold (B)
<b>DS302</b>	\$40 Net	<b>DF071-2</b> Oak and Acorn Finial on 2¼" Smooth Pole in Sage (B)
<b>DS303</b>	\$40 Net	<b>DF530-2</b> Scroll Finial on 2¼" Scroll Inlay Pole in French Nobility with Gold Leaf Antiqued Accents (C)
<b>DS304</b>	\$40 Net	<b>DE053-3</b> Stanza Rod-Enders on 3" Smooth Pole in Queensland Walnut with Gold Leaf-Traditional Accents (C)
<b>DS300</b>	\$160 Net	Set of All 4

### Catalog Set



p. 82

**DS400** - 8½"W x 11"H

Includes:

- 88 page full color catalog
- Price list book and order forms for all products

**Price:** \$8 Net

### Promotional Binder



p. 82

**DS500** - 12½"W x 11¾"H x 4½"D

Includes:

- 88 page full color catalog
- Price list book and order forms for all products
- 58 swatches showing unique Décor Finishes
- 5 swatches showing SwissCrystal-On-Iron Finishes

**Price:** \$85 Net

### Individual Finish Swatch



p. 82

**DS600** - 1⅞"W x 2⅝"H

Single color swatch of any of our 58 Décor Finishes or 5 SwissCrystal-On-Iron Finishes

**Price:** \$2.50 Net

# TERMS OF SALE

## 1. PRICES & SPECIFICATIONS

- a. All prices (except Promotional Items) listed are retail prices in US\$ and are FOB warehouse.
- b. Prices and terms of sale are subject to change without notice.
- c. Prices and specifications are subject to corrections resulting from errors, omissions, and modifications.
- d. Specifications listed in this price list supersede those listed in the catalog.
- e. Due to the nature of hand-crafted items, dimensions may vary slightly from piece to piece. Items in the same order will be matched as closely as possible.

## 2. TERMS

- a. Customer accounts are opened under the following terms: Cash on Delivery (COD), Payment Before Shipping (Proforma), or Credit Card (Visa or MasterCard).
  1. Credit card accounts give specific permission to the Company to charge the credit card upon completion of the order.
  2. COD accounts will be charged a COD fee of \$12.00 per box on all shipments. This does not include Will Call orders.
- b. **All orders \$2000 and above need a 50% deposit prior to commencement of manufacturing.**
- c. A \$50.00 fee will be charged for any returned checks.
- d. Late payments on a Net 30 account will cause the account to become COD, Proforma, or Credit Card. **A late fee of \$20.00, PLUS 1.5% interest per month (18% per year) will be added to all invoices not paid within 30 days.**
- e. Interest charges are applied on the 45th day from the date of shipment.
- f. The Company reserves the right to review and change account terms at any time.
- g. Any and all legal or collection costs that are incurred in procuring past due accounts will be the sole responsibility of the customer, and will be added to outstanding account balances.
- h. **All requests for credit on invoices that are priced incorrectly or contain other invoicing errors should be sent to the Company in writing within 30 days of the invoice date.**

## 3. NEW ORDERS

- a. To ensure correct ordering information, we request all orders be faxed or emailed using our Drapery Hardware Order forms.
- b. **The Company has provided a comprehensive ordering information guide for its products. Please review it carefully before placing an order.**
- c. Please review orders for accuracy and completeness before sending.
- d. Manufacturer's best judgment will prevail on order details not provided before processing an order.
- e. **Any errors or omissions are the customer's sole responsibility.**
- f. Verbal orders will **NOT** be accepted at any time.
- g. Orders may be sent via fax, standard mail, or email.
- h. Orders received by 12:00 noon Pacific Standard Time will be deemed to be received on that business day.
- i. **Incomplete orders, or orders with questions will be deemed to be received on the date that all queries have been answered.**
- j. **Duplicate orders sent and executed will be the customer's sole responsibility.**
- k. The Company will send an Order Confirmation to customers within 72 hours of receipt of an order.

- l. All customers with a physical presence in California are required to have a valid resale certificate on file with the Company. Sales tax will be charged on orders from California customers not having a valid resale certificate on file with the Company.

## 4. ORDER CHANGES / REVISIONS

- a. **All revisions and changes MUST be in writing, and should be submitted via fax or email.**
- b. Customer changes and revisions will **NOT** be accepted after three working days from receipt of an order.
- c. Changes and revisions on any rush order will not be accepted after 24 hours from receipt of an order.
- d. There will be a \$20.00 charge for customer changes received more than 48 hours after the original order.
- e. NO charge for: changing shipping instructions up to the scheduled ship date; to add items to an order up to two working days from receipt of an order; making changes that stem from clarification of orders.
- f. **Any changes or revisions may affect the shipping date.**

## 5. ORDER CANCELLATIONS AND HOLDS

- a. Since all orders are hand-made, custom to order, no cancellations or holds will be accepted after three business days from the date of an order.
- b. Any orders cancelled or held beyond three days of placing the order will be subject to a cancellation charge of \$25.00, plus a 35% restocking fee, with the exception of items with Gold or Silver Leaf finishes (which cannot be returned).
- d. Rush orders cannot be cancelled or put on hold.
- e. All requests for order holds or cancellations must be sent in writing.

## 6. PRODUCTION / DELIVERY

- a. The due date listed on the sales order confirmation indicates that the order will be shipped or ready for Will Call at the **END** of that business day.
- b. Please see our Production Times Guide on page 93 for shipping times based on finish and type of order.
- c. **Rush orders** are accepted on a limited basis. These should be handled as an exception and not a rule. Rush orders may be refused for any reason whatsoever. Please see our Production Times Guide on page 93 for Rush order times and upcharges.
- d. Scheduled ship dates are based on production variables and are difficult to expedite. Any date changes will incur the change charge as delineated above. (Large and non-standard orders may require more time.)
- e. The nature of the order will be taken into account when assigning scheduled ship dates.
- f. **All orders are shipped FOB warehouse. Delivery charges are to customer's account.**
- g. Shipping charges include handling and packaging charges. If a customer chooses to have the shipping charges billed to his shipping account (FedEx, UPS) or his trucking company account, there will be a 2% of net invoice charge added for packaging only.
- h. Certain orders may require additional packaging and/or special handling, which will be an additional charge on the order (ie. bent rods).
- i. New FedEx surcharge above 96" in length per box will be added in addition to the shipping and handling charges.

## 7. WILL CALL ORDERS

- a. The due date listed on the sales order confirmation indicates that the order will be ready for Will Call at the

# TERMS OF SALE

**END** of that business day.

- b. All Will Call orders will be invoiced and mailed on the date that the order is completed, and will be due according to the customer's account terms.
- c. Accounts with Payment Before Delivery (Proforma), COD, or Credit Card terms must pay for their Will Call orders in full at the time of pick up.
- d. **Will Call orders should be picked up within two weeks of completion.**
- e. Will Call orders not picked up after three weeks from completion will be subject to a storage charge of \$20.00 per week.
- f. Will Call orders not picked up after six weeks will be returned to inventory and be subject to a 50% production fee.
- g. Please confirm that production of the order is complete before arriving to pick it up.

## 8. RETURN POLICY

- a. Due to the custom nature of the Design Art line, with the exception of defects and damages, most items are **NOT** available for return. Please see our Return Policy Guide on page 92.
- b. **No product will be accepted for return without prior authorization. Please call your Customer Service Executive prior to returning any merchandise.**
  - 1. Your Customer Service Executive will issue a Return Merchandise Authorization (RMA) number at our discretion. Items with Gold or Silver Leaf finishes cannot be returned.
  - 2. **The RMA# MUST be noted on all packages that are returned to the Company.**
  - 3. If the return is due to Company error or omission, a call tag will be issued to pick up the material to be returned.
  - 4. Shipping charges on all returns other than defective or damaged merchandise will be borne by the customer.
- c. Exercise care to adequately package returned products. Return credit will not be issued for unauthorized or damaged returns.
- d. On applicable items, credit for returns will be issued. Credit for restocked items is **"on account"**, and will be applied against open invoices and/or future orders. At no time will there be a cash/check/credit card refund.
- e. **No return request will be accepted after 30 days from the invoice date.**

## 9. DEFECTIVE, DAMAGED OR MISSING MERCHANDISE

- a. **Orders MUST be checked immediately upon receipt.**
  - 1. Packages that have visible damage or are open and may be missing items should be refused.
  - 2. It **MUST** be noted on the Bill of Lading if there is ANY damage to packaging that may indicate the possibility of concealed damage. If possible, photograph the damaged packaging while the driver is still present.
  - 3. Inspect the contents of ALL packages to insure there is no concealed damage from shipping.
  - 4. If an order is damaged in shipping, ALL packing materials must be kept for inspection. Please photograph the damaged product with packaging.
  - 5. Any defective or missing material **MUST** be reported within one week from receipt of order to the Company.
  - 6. Any missing packages should be reported to the Company within 48 hours of receipt of order.
  - 7. The Company will be responsible for any shipping related claims shipped on the Company's account.
- b. The Company will repair or replace any defective merchandise at its sole discretion.

- c. The Company will be responsible for any freight charges to return defective merchandise. A RMA# and call tag will be issued by the Customer Relations Executive.
- d. If, upon examination, the merchandise is found to be **NOT** defective, the customer will be charged freight.

## 10. INSTALLATION

- a. It is of the utmost importance that all Company products be installed properly by a professional installer.
- b. For questions regarding securing products to a particular surface, please consult a professional installer.
- c. **The Company will not be responsible nor liable under any circumstances for installation or any costs relating to installation, removal, or reinstallation. The Company will only repair or replace any defective or damaged product.**

## 11. FINISHES

- a. All finishes are done by hand, thus some variation in tone and appearance will occur.
- b. All product prices include finishes. Please see this price list for finish groups.
- c. The Company can custom match most finishes.
  - 1. All custom finishes will require a strike-off approved by the customer before the Company finishes the product. The strike-off has a one time net charge of \$40.00, and turn around time is 3 business days.
  - 2. Please contact Your Customer Service Executive for a quote on all custom finishes.
- d. **The lithographic color reproductions presented in the catalog may not accurately reflect the true tones, lusters, and depths of the finishes. Please refer to actual finish samples (Color Selector Sets) for a more accurate representation.**

## 12. CUSTOM ORDERS

- a. The Company is a true custom manufacturer, and as such we are able to manufacture products to almost any specification.
- b. Any item that varies from the specifications published in the Company catalogs and price lists will be subject to a minimum customization charge of \$60.00 per item retail. This should be added to the standard cost of the product.
- c. If the customization charge is greater than \$60.00 per item retail, the Company will contact the customer with a price quote and wait for approval before proceeding with the order.

## 13. WARRANTY

- a. The Company offers a standard limited warranty on all merchandise to be free from manufacturing defects for a period of one year from the date of purchase.
- b. This warranty does **NOT** apply to normal wear and tear, damage from mishandling, abuse, or exposure due to climatic conditions.
- c. **This warranty specifically excludes any product that is used in an external environment.**

## 14. EFFECTIVE DATE

- a. **These terms of sale are effective as of April 1, 2015.**
- b. These terms of sale may be revised, amended, or replaced at any time at the Company's discretion.

## 15. DISCLAIMER

- a. The Company endeavors to provide accurate information in all of its catalogs and price lists. However, the Company is **NOT** responsible for any errors or omissions of any kind, nor is the Company liable for any charges that stem from any errors or omissions on its part.
- b. All orders placed with the Company are governed by the terms of sale in effect at the time of ordering.

# TERMS OF SALE

## RETURN POLICY GUIDE\*

Item	Return Policy
Bohemia Crystal	Return with a restocking fee of 35%.
Decal Finials, Decal SwissCrystal Base, and Decal Bracket	Return at the Company's discretion. A 35% restocking fee will apply.
Finials	Return at the Company's discretion. A 35% restocking fee will apply.
Holdbacks	Return at the Company's discretion. A 35% restocking fee will apply.
Iron Batons	Cannot be returned.
Iron Brackets	Return with a restocking fee of 35% with the exception of Gold or Silver Leaf Finishes.
Iron Rings	Return with a restocking fee of 35% with the exception of Gold or Silver Leaf Finishes.
Iron Rods	Cannot be returned.
Medallions	Return at the Company's discretion. A 35% restocking fee will apply.
Rod-Enders	Return at the Company's discretion. A 35% restocking fee will apply.
SwissCrystal	Return with a restocking fee of 35%.
SwissCrystal Bases	Return at the Company's discretion. A 35% restocking fee will apply.
Traversing Motorized Controls	Return with a restocking fee of 35%.
Traversing Systems	Cannot be returned.
Wood Batons	Return at the Company's discretion. A 35% restocking fee will apply.
Wood Brackets - Accent	Return at the Company's discretion. A 35% restocking fee will apply.
Wood Brackets - Decorative	Return at the Company's discretion. A 35% restocking fee will apply.
Wood Brackets - Standard	Return with a restocking fee of 35% with the exception of Gold or Silver Leaf Finishes.
Wood Pole Centerpieces	Return at the Company's discretion. A 35% restocking fee will apply.
Wood Poles	Cannot be returned.
Wood Poles - Inlay	Cannot be returned.
Wood Rings	Return at the Company's discretion. A 35% restocking fee will apply.
ShowOffs	Cannot be returned.
TableTopper Display	Cannot be returned.
Wall Displays	Cannot be returned.

\*Items with Gold or Silver Leaf Finishes **cannot** be returned:

Gold Leaf-Antiqued (DP941B), Gold Leaf-Burnished (DP926B), Gold Leaf-Polished (DP927B), Gold Leaf-Traditional (DP928B), Silver Leaf-Burnished (DP944B), and Silver Leaf-Polished (DP945B)

# TERMS OF SALE

## PRODUCTION TIMES

Type of Order → Finish Group ↓	Working Day Until Shipped			
	Regular	Rush 25% Upcharge (Net Pricing)	Hot Rush 50% Upcharge (Net Pricing)	Hot Hot Rush* 100% Upcharge (Net Pricing)
Décor Finish A	15	12	10	7
Décor Finish B and Dual Finish System with 11 Accent Finishes (C)	20	15	12	10

Please see Terms of Sale on page 90 for more details on Production and Delivery.  
\*Hot Hot Rush orders are taken on a case-by-case basis. Please call for confirmation.

## SUMMARY OF CHARGES

Below is a listing of charges found in Terms of Sale (pages 90-92).

Type of Charge	Amount
Cancellation Charge	\$25 net plus 35% restocking
COD per Box	\$12 net
Customization Charge	\$60 retail per item minimum
Late Payments	\$20 net plus 1.5% interest per month
Order Changes after 48 Hours	\$20 net
Restocking Fee	35%
Returned Checks	\$50 net
Shipping billed to Customer's Shipping Account	2% net invoice value for packaging
Strike-off	\$40 net
Will Call Production Fee	50% after six weeks, order returned to inventory
Will Call Storage Charge	\$20 net a week after three weeks



# ORDER FORM

For Design Art by Orion Products Only

CUSTOMER INFORMATION									
Company Name:					Page ___ of ___				
Ordered By (Name):					Order Date:				
Side Mark:					Account#:				
Phone:					PO#:				
Ship to:					Drawing/Template: Yes: <input type="checkbox"/> No: <input type="checkbox"/>				
Street:					Order Type: Reg: <input type="checkbox"/> Rush: <input type="checkbox"/> Hot Rush: <input type="checkbox"/>				
City:			State:		Zip:		Delivery Location: Business: <input type="checkbox"/> Residential: <input type="checkbox"/>		
Ship Via:	FedEx Ground: <input type="checkbox"/>	3 Day: <input type="checkbox"/>	2 Day: <input type="checkbox"/>	Overnight: <input type="checkbox"/>	Truck: <input type="checkbox"/>	Will Call: <input type="checkbox"/>	Other:		

POLES • RODS									
Qty.	Product #	Inlay # (Inlay Poles Only)	Dia. (In.)	Length (In.) (Not Including Finials)	Wood Pole Splice, Miter Splice or Miter Return #	Miter Return (Depth in In.)	Décor Finish / SwissCrystal-On-Iron Finish Name/Number	*Dual Finish System Accent Finish  - Inlay Only Name/Number	Room ID

We splice any wood pole or iron rod over 106" to save on shipping charges using FedEx. (FedEx surcharge above 96" in length per box will be added in addition to the shipping and handling charges.) Poles or rods not specified as one piece will be spliced in the center, unless a splice location is otherwise noted.

Special Instructions:

FINIALS • ROD-ENDERS • BOHEMIA CRYSTAL						
Qty.	Product #	Decal # (DF634X or DF633X Only)	For Pole Dia. (In.)	Décor Finish Name/Number	*Dual Finish System Accent Finish Name/Number	Room ID

Special Instructions:

SWISSCRYSTAL & BASES (WOOD & IRON)							
Qty.	SwissCrystal Product #	Base Product # (Leave blank for Standard Base)	Decal # (DY635X Only)	For Pole Dia. (In.)	Décor Finish Name/Number	*Dual Finish System Accent Finish  - Wood Only Name/Number	Room ID

Special Instructions:

BRACKETS							
Qty.	Product #	Decal or Inlay # (DB555X or DB605X Only)	For Pole Diameter (Inches)	Projection (Inches)	Décor Finish / SwissCrystal-On-Iron Finish Name/Number	*Dual Finish System Accent Finish Name/Number	Room ID

Special Instructions:

\*Not all items are available with our Dual Finish System Accent Finishes . Please see item for availability.

RINGS						
Qty.	Product #	Ring Size Inner Diameter (Inches)	For Pole Diameter (Inches)	Décor Finish / SwissCrystal-On-Iron Finish Name/Number	*Dual Finish System Accent Finish  Name/Number	Room ID

Special Instructions:

BATONS						
Qty.	Product #	Length in Inches (Tip to Tip)	Clip or Ring	Ring Size Inner Diameter (Inches)	Décor Finish / SwissCrystal-On-Iron Finish Name/Number	Room ID

Special Instructions:

HOLDBACKS • MEDALLIONS • STAIR NEWELS								
Qty.	Product # Finial, Rod-Ender, SwissCrystal, or Bohemia Crystal	SwissCrystal Base or Medallion Product # (Leave blank for Standard Base)	Decal # (DF634X, DF633X or DY635X Only)	Type Iron U-Bend, Iron Post, Wood Post, Pedestal # or Flush Mount / Stair Newel	Proj. (In.)	Décor Finish / SwissCrystal-On-Iron Finish Name/Number	*Dual Finish System Accent Finish  Name/Number	Room ID

Special Instructions:

CENTERPIECES					
Qty.	Product #	For Pole Diameter (Inches)	Décor Finish Name/Number	*Dual Finish System Accent Finish  Name/Number	Room ID

Special Instructions:

SELLING TOOLS & ADDITIONAL					
Product #	Qty.	Product #	Qty.	Product #	Qty.
DS100 Wall Display Set		DS400 Catalog Set		DS700 Touch Up Paint	
DS200 TableTopper		DS500 Catalog Binder Set		Other:	
DS300 ShowOffs		DS600 Individual Finish Swatch		Other:	

Special Instructions:

\*Not all items are available with our Dual Finish System Accent Finishes . Please see item for availability.



# ORDER FORM: Manual Traversing

For Design Art by Orion Products Only

CUSTOMER INFORMATION							
Company Name:					Page ____ of ____		
Ordered By (Name):					Order Date:		
Side Mark:					Account#:		
Phone:					PO#:		
Ship to:					Drawing/Template: Yes: <input type="checkbox"/> No: <input type="checkbox"/>		
Street:					Order Type: Reg: <input type="checkbox"/> Rush: <input type="checkbox"/> Hot Rush: <input type="checkbox"/>		
City:			State:		Zip:		Delivery Location: Business: <input type="checkbox"/> Residential: <input type="checkbox"/>
Ship Via:	FedEx Ground: <input type="checkbox"/>	3 Day: <input type="checkbox"/>	2 Day: <input type="checkbox"/>	Overnight: <input type="checkbox"/>	Truck: <input type="checkbox"/>	Will Call: <input type="checkbox"/>	Other:

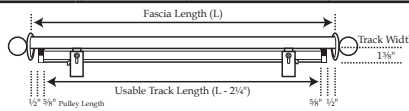

**\*Measurement Guidelines**

- Please specify fascia length when ordering.
- Usable track length will be 2 1/4" shorter than fascia length. (L - 2 1/4")

Total Number of Rod Sets Ordered on this PO: \_\_\_\_\_

1	Qty	Set Product #	Inlay # (Inlay Poles Only)	Pole Dia. (Inches)	Length* (Inches) (Not Including Finials)	Décor Finish Name/Number	*Dual Finish System Accent Finish  - Inlay Only Name/Number							
	Finial, Rod-End, SwissCrystal, Bohemia Crystal or Miter Return Product #		SwissCrystal Base Product # (Leave blank for Standard Base)	Decal # (DF634X, DF633X or DY635X Only)	Miter Return Projection	Décor Finish Name/Number	*Dual Finish System Accent Finish  Name/Number							
	Type of Draw	Opening	Cord Drop	Cord Length	Track System		Track Finish							
	<input type="checkbox"/> Cord <input type="checkbox"/> Baton ____" # _____ Qty _____	<input type="checkbox"/> Left Stack <input type="checkbox"/> Right Stack <input type="checkbox"/> Center Open	<input type="checkbox"/> Left <input type="checkbox"/> Right	<input type="checkbox"/> Standard (8 Feet) <input type="checkbox"/> Other: _____"	<input type="checkbox"/> Pinch Pleat <input type="checkbox"/> RippleFold: <table style="display: inline-table; vertical-align: middle;"> <tr> <td><input type="checkbox"/> 60%</td> <td><input type="checkbox"/> 80%</td> <td>Master Type</td> </tr> <tr> <td><input type="checkbox"/> 100%</td> <td><input type="checkbox"/> 120%</td> <td><input type="checkbox"/> Butt</td> </tr> <tr> <td colspan="3"><input type="checkbox"/> Overlap</td> </tr> </table>	<input type="checkbox"/> 60%	<input type="checkbox"/> 80%	Master Type	<input type="checkbox"/> 100%	<input type="checkbox"/> 120%	<input type="checkbox"/> Butt	<input type="checkbox"/> Overlap		
<input type="checkbox"/> 60%	<input type="checkbox"/> 80%	Master Type												
<input type="checkbox"/> 100%	<input type="checkbox"/> 120%	<input type="checkbox"/> Butt												
<input type="checkbox"/> Overlap														
Mounting Bracket Type	Bracket Projection (Single Sets Only)	Additional Support Brackets (Qty)	# Front Track Rings or Traversing Glides	Ring Product #	Back Track For Double Set	# Back Track Traversing Glides								
<input type="checkbox"/> Wall Mount <input type="checkbox"/> Ceiling Mount	<input type="checkbox"/> 3 1/2" to 4 1/2" <input type="checkbox"/> 6" to 7"	<input type="checkbox"/> End _____ <input type="checkbox"/> Support _____ <input type="checkbox"/> Ceiling _____	<input type="checkbox"/> No Rings <input type="checkbox"/> 4 Per Foot (Std.) <input type="checkbox"/> Other: ____ (Total)		<input type="checkbox"/> Track & Fascia <input type="checkbox"/> Track Only	<input type="checkbox"/> 4 Per Foot (Std.) <input type="checkbox"/> Other: ____ (Total)								
2	Qty	Set Product #	Inlay # (Inlay Poles Only)	Pole Dia. (Inches)	Length* (Inches) (Not Including Finials)	Décor Finish Name/Number	*Dual Finish System Accent Finish  - Inlay Only Name/Number							
	Finial, Rod-End, SwissCrystal, Bohemia Crystal or Miter Return Product #		SwissCrystal Base Product # (Leave blank for Standard Base)	Decal # (DF634X, DF633X or DY635X Only)	Miter Return Projection	Décor Finish Name/Number	*Dual Finish System Accent Finish  Name/Number							
	Type of Draw	Opening	Cord Drop	Cord Length	Track System		Track Finish							
	<input type="checkbox"/> Cord <input type="checkbox"/> Baton ____" # _____ Qty _____	<input type="checkbox"/> Left Stack <input type="checkbox"/> Right Stack <input type="checkbox"/> Center Open	<input type="checkbox"/> Left <input type="checkbox"/> Right	<input type="checkbox"/> Standard (8 Feet) <input type="checkbox"/> Other: _____"	<input type="checkbox"/> Pinch Pleat <input type="checkbox"/> RippleFold: <table style="display: inline-table; vertical-align: middle;"> <tr> <td><input type="checkbox"/> 60%</td> <td><input type="checkbox"/> 80%</td> <td>Master Type</td> </tr> <tr> <td><input type="checkbox"/> 100%</td> <td><input type="checkbox"/> 120%</td> <td><input type="checkbox"/> Butt</td> </tr> <tr> <td colspan="3"><input type="checkbox"/> Overlap</td> </tr> </table>	<input type="checkbox"/> 60%	<input type="checkbox"/> 80%	Master Type	<input type="checkbox"/> 100%	<input type="checkbox"/> 120%	<input type="checkbox"/> Butt	<input type="checkbox"/> Overlap		
<input type="checkbox"/> 60%	<input type="checkbox"/> 80%	Master Type												
<input type="checkbox"/> 100%	<input type="checkbox"/> 120%	<input type="checkbox"/> Butt												
<input type="checkbox"/> Overlap														
Mounting Bracket Type	Bracket Projection (Single Sets Only)	Additional Support Brackets (Qty)	# Front Track Rings or Traversing Glides	Ring Product #	Back Track For Double Set	# Back Track Traversing Glides								
<input type="checkbox"/> Wall Mount <input type="checkbox"/> Ceiling Mount	<input type="checkbox"/> 3 1/2" to 4 1/2" <input type="checkbox"/> 6" to 7"	<input type="checkbox"/> End _____ <input type="checkbox"/> Support _____ <input type="checkbox"/> Ceiling _____	<input type="checkbox"/> No Rings <input type="checkbox"/> 4 Per Foot (Std.) <input type="checkbox"/> Other: ____ (Total)		<input type="checkbox"/> Track & Fascia <input type="checkbox"/> Track Only	<input type="checkbox"/> 4 Per Foot (Std.) <input type="checkbox"/> Other: ____ (Total)								





# ORDER FORM: Motorized Traversing

For Design Art by Orion Products Only

CUSTOMER INFORMATION							
Company Name:				Page ____ of ____			
Ordered By (Name):				Order Date:			
Side Mark:				Account#:			
Phone:				PO#:			
Ship to:				Drawing/Template: Yes: <input type="checkbox"/> No: <input type="checkbox"/>			
Street:				Order Type: Reg: <input type="checkbox"/> Rush: <input type="checkbox"/> Hot Rush: <input type="checkbox"/>			
City:		State:		Zip:		Delivery Location: Business: <input type="checkbox"/> Residential: <input type="checkbox"/>	
Ship Via:	FedEx Ground: <input type="checkbox"/>	3 Day: <input type="checkbox"/>	2 Day: <input type="checkbox"/>	Overnight: <input type="checkbox"/>	Truck: <input type="checkbox"/>	Will Call: <input type="checkbox"/>	Other:

- Somfy traversing tracks come assembled, are shipped in one piece, and are available up to 30' (360"). Poles over 16' (192") are spliced.
- The maximum width for a FedEx shipment is 8' 6" (102"). All sets over this length must be shipped by common carrier (truck line). Please contact customer service as delivery restrictions apply.

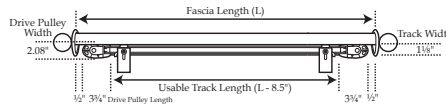

- \*Measurement Guidelines**
- Please specify fascia length when ordering.
  - Usable track length will be 8½" shorter than fascia length. (L - 8½")

**Total Number of Rod Sets Ordered on this PO:** \_\_\_\_\_

Qty	Set Product #	Inlay # (Inlay Poles Only)	Pole Dia. (Inches)	Length* (Inches) (Not Including Finales)	Décor Finish Name/Number	*Dual Finish System Accent Finish  - Inlay Only Name/Number
1	Fial, Rod-End, SwissCrystal, Bohemia Crystal or Miter Return Product #	SwissCrystal Base Product # (Leave blank for Standard Base)	Decal # (DF634X, DF633X or DY635X Only)	Miter Return Projection	Décor Finish Name/Number	*Dual Finish System Accent Finish  Name/Number
Opening		Motor	Motor Placement	Track System		Track Finish
<input type="checkbox"/> Left Stack <input type="checkbox"/> Right Stack <input type="checkbox"/> Center Open			<input type="checkbox"/> Left <input type="checkbox"/> Right	<input type="checkbox"/> Pinch Pleat <input type="checkbox"/> RippleFold: <div style="display: flex; justify-content: space-between; width: 100%;"> <span><input type="checkbox"/> 80%</span> <span><input type="checkbox"/> 100%</span> <span><input type="checkbox"/> 120%</span> </div> Master Type <input type="checkbox"/> Butt <input type="checkbox"/> Overlap		<input type="checkbox"/> Antique Bronze <input type="checkbox"/> Black <input type="checkbox"/> Gold <input type="checkbox"/> Silver <input type="checkbox"/> White
Mounting Bracket Type	Bracket Projection (Single Sets Only)	Additional Support Brackets (Qty)	# Front Track Rings or Traversing Glides	Ring Product #	Back Track For Double Set	# Back Track Traversing Glides
<input type="checkbox"/> Wall Mount <input type="checkbox"/> Ceiling Mount	<input type="checkbox"/> 3½" to 4½" <input type="checkbox"/> 6" to 7"	<input type="checkbox"/> End _____ <input type="checkbox"/> Support _____ <input type="checkbox"/> Ceiling _____	<input type="checkbox"/> No Rings <input type="checkbox"/> 4 Per Foot (Std.) <input type="checkbox"/> Other: ____ (Total)		<input type="checkbox"/> Track & Fascia <input type="checkbox"/> Track Only	<input type="checkbox"/> 4 Per Foot (Std.) <input type="checkbox"/> Other: ____ (Total)

**Controls**

Remote	Finish	Qty
<input type="checkbox"/> Telis 1 RTS	<input type="checkbox"/> Pure	
<input type="checkbox"/> Telis 5 RTS	<input type="checkbox"/> Silver	
<input type="checkbox"/> Telis 1 Chronis RTS	<input type="checkbox"/> Black	

Switch	Finish	Qty
<input type="checkbox"/> DecoFlex 1	<input type="checkbox"/> White	
<input type="checkbox"/> DecoFlex 5	<input type="checkbox"/> Ivory	
	<input type="checkbox"/> Black	

**Additional Accessories**

Product #	Qty	Product #	Qty

Please specify how we should program your remote or switch. If no specification is made, we will program each track per channel.

Notes: \_\_\_\_\_

\_\_\_\_\_

\_\_\_\_\_

\_\_\_\_\_

\_\_\_\_\_

\*Not all items are available with our Dual Finish System Accent Finishes . Please see item for availability.

# MEASUREMENTS

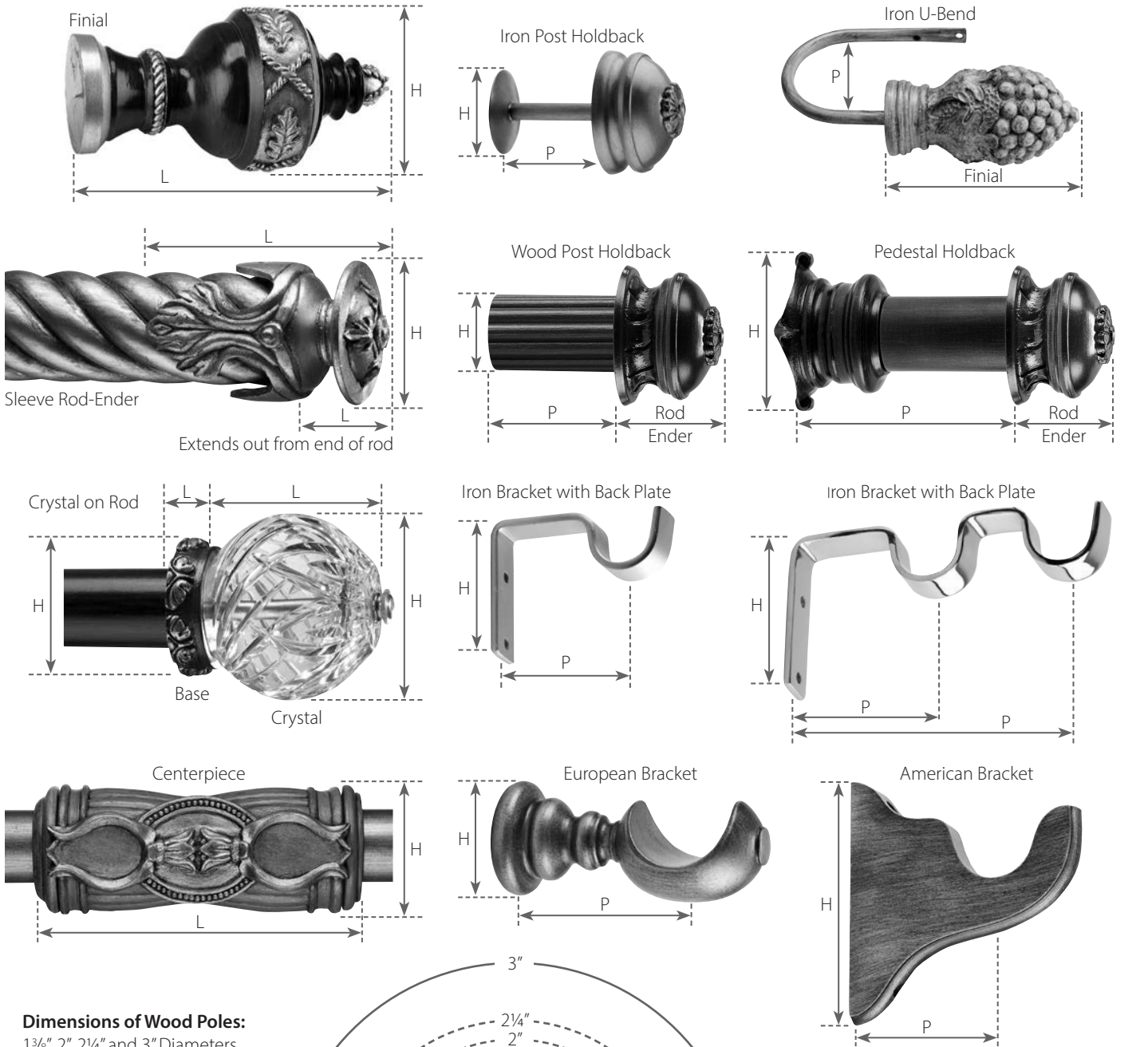

**Dimensions of Wood Poles:**  
 $1\frac{3}{8}$ ", 2",  $2\frac{1}{4}$ " and 3" Diameters

**Dimension of Iron Rods:**  
 $1\frac{1}{4}$ " Diameter

- Table
- H = Height
- L = Length
- P = Projection
- ID = Inside Diameter
- OD = Outside Diameter
- T = Thickness

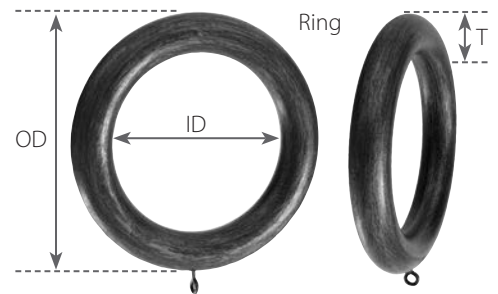
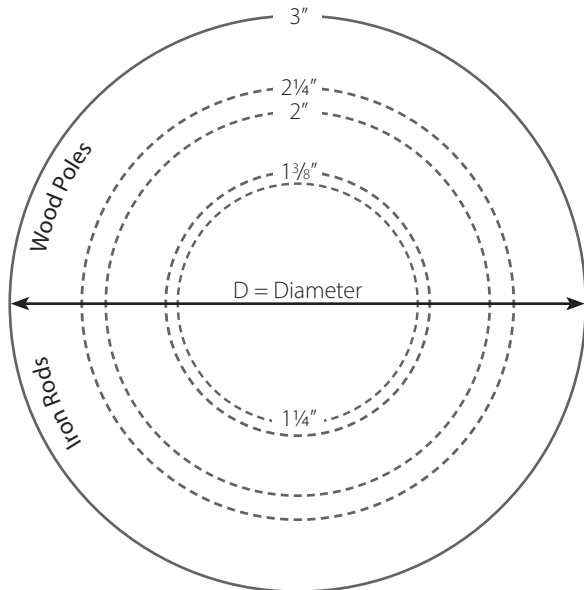





Feb 2018



[www.designartbyorion.com](http://www.designartbyorion.com)

