



Quality Wholesale Window Coverings

Contract • Hospitality • Healthcare • Residential

ph 866-753-1113 email customerservice@porterpreston.com www.porterpreston.com



THE FINIAL COMPANY™

Custom for Every Style

MODERN • TRANSITIONAL • TRADITIONAL

Drapery Hardware Catalog



◀ our standard finishes

The Finial Company offers a comprehensive range of sophisticated hand painted and plated finishes. Our 10 new artisan crafted finishes include a trend right mix of elegant rustic-inspired finishes, mid-tone neutrals and modern metallics that complement today's textiles, furnishings and home décor accessories. Our sample chip design shows both smooth and detailed surfaces, indicating how the finish will look on your selected product.

For your convenience, you can unfold this cover to view all of our standard finishes as you browse our product catalog.

◀ our process

We specialize in combining quality craftsmanship with elegant hand painted finish details that deliver a custom quality product every time. Products are hand painted after we receive your order. The entire order is painted together to ensure a consistent finish. The nature of hand finishing causes some acceptable variation in finish, as each order is truly one-of-a-kind.

For more details on Custom Finish Options, please refer to the Retail Price List. Our talented artisans enjoy the challenge of creating any finish that you can envision.



custom designs inspired by you

For any design you envision, The Finial Company can make it a reality. From one-of-a-kind creations to our broad mix of hand crafted drapery hardware collections, you will never be limited by design styles, finish selections, window shapes or unusual floor plans. We've updated our expansive window hardware assortment with new finish options, customized details and modern finial designs; including the new Modern Metal Collection that offers over 400 innovative design combinations. Whether tailoring an existing style to fit your client's specific needs or bringing a new design to life inspired by your unique vision, our talented artisans are ready to help create any window design you can imagine.

THE FINIAL COMPANY™



table of contents

3 metal

1 1/8"-1 3/8" modern metal collection	3
1 3/8" metal collection	10

15 steel

1/2" collection	15
3/4" collection	18
1" collection	25
1 1/4" collection	32
1 1/2"-1 3/4" collection	39
outdoor hardware	45

49 custom solutions

custom pole returns	50
custom steel brackets	56
custom accessories	57
custom arches	59
custom finishes	60

61 wood & resin

1 3/8" diameter collection	61
2"-2 1/4" diameter collection	68
3" diameter collection	81
rosettes	88
tiebacks	93
crests	94

95 traverse systems

light duty traverse	95
heavy duty traverse	98
motorized traverse	102
how to order traverse	108
display boards	110
how to measure	111
terms & conditions	112
index	113



1 1/8"

1 3/8"

metal

1 1/8" - 1 3/8" modern metal collection	3
1 3/8" metal collection	10

actual pole sizes

1¹/₈"

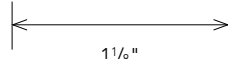
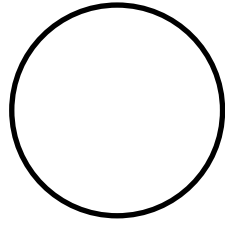

1¹/₈"
TFCM118

1³/₈"

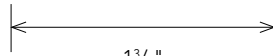
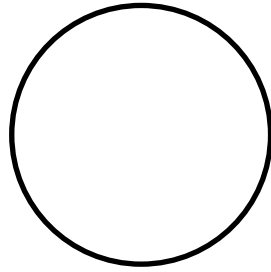

1³/₈"
TFCM138

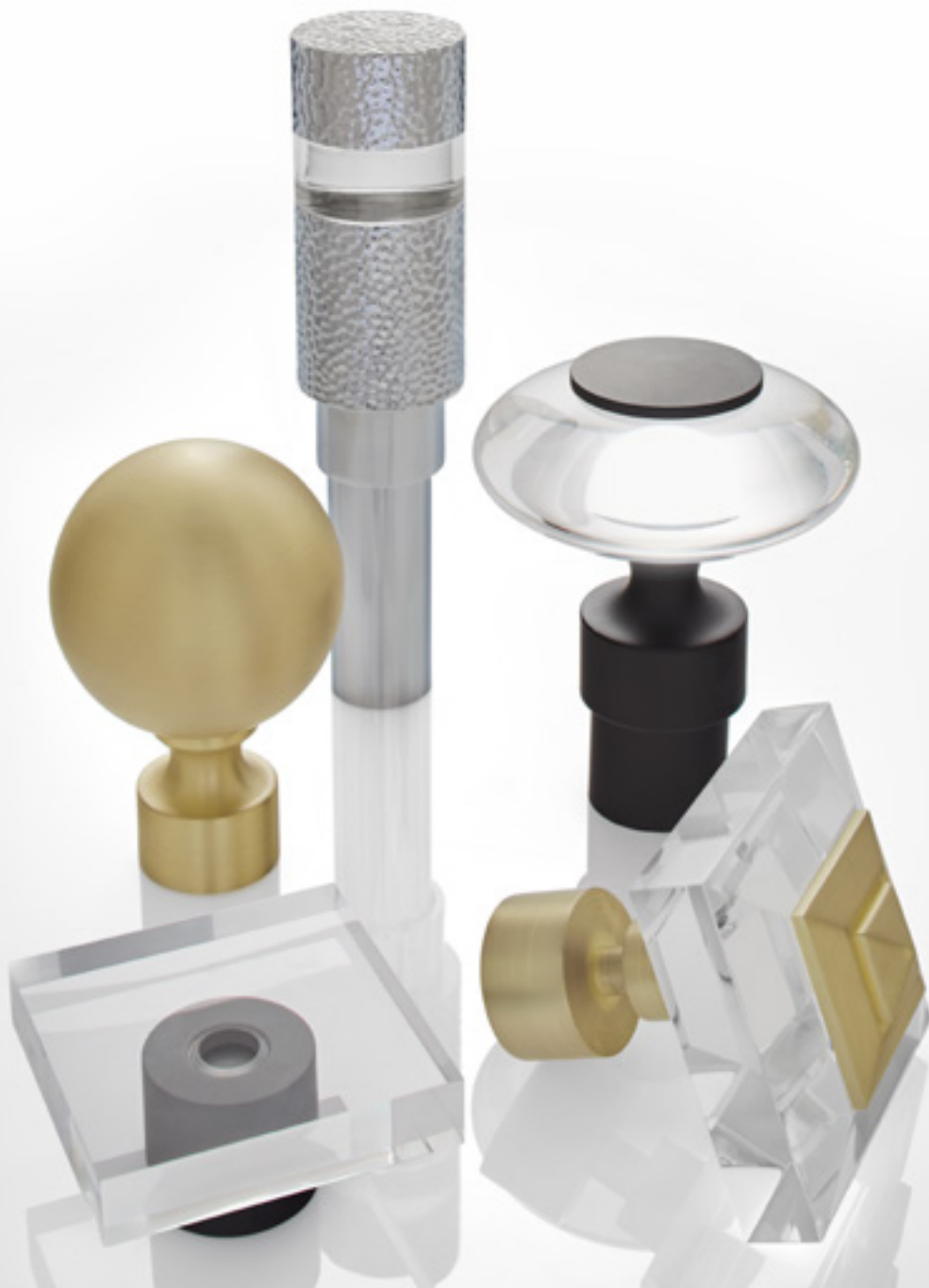

1¹/₈" - 1³/₈" modern metal collection

The new Modern Metal Collection features clean lines and trend-right acrylic styles available in 5 contemporary finishes. Designed to be customized, the collection offers three mix & match cuff and collar options in 1¹/₈" and 1³/₈" diameters that can be combined with any of our 14 finials to create sleek to soft modern styles in more than 400 design combinations.

1 1/8" - 1 3/8"
modern metal

modern metal design combinations

1

Select Finial Design:

Modern Metal Collection finials are designed to coordinate with both 1 1/8" and 1 3/8" pole diameters.



Bryant finial
Satin Gold
pictured with
1 1/8" modern cuff
in Satin Gold

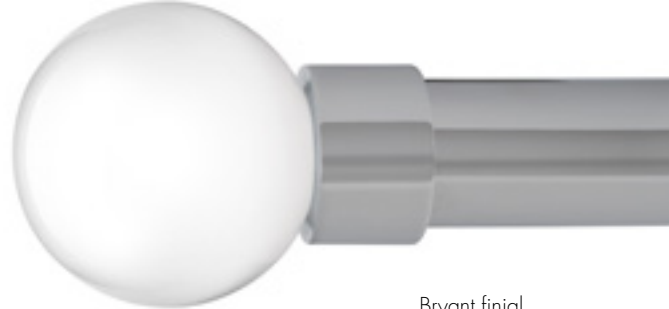

Bryant finial
Acrylic
pictured with
1 3/8" modern cuff
in Chrome

2

Choose Pole Diameter:

1 1/8" and 1 3/8" poles are available in all 5 modern finishes.



Bryant finial
Satin Gold
pictured with
1 1/8" modern collar
in Satin Gold



Bryant finial
Acrylic
pictured with
1 3/8" modern collar
in Chrome

3

Select a Cuff or Collar:

Select from any of our 3 cuff and collar designs in your pole diameter. Mix or match with our 5 modern finishes.

Sold separately on page 6.



Bryant finial
Satin Gold
pictured with
1 1/8" transitional collar
in Satin Gold



Bryant finial
Acrylic
pictured with
1 3/8" transitional collar
in Chrome

1 1/8" - 1 3/8" modern metal



TFCM600 NEW
Bryant
 2 7/8"L x 2 3/4"W
 Satin Gold
 pictured with
 1 1/8" modern cuff
 and TFCM118 pole



TFCM600/CL NEW
Bryant Acrylic
 2 7/8"L x 2 3/4"W
 pictured with
 1 3/8" transitional collar
 and TFCM138 pole
 in Chrome



TFCM601 NEW
Declan
 2 1/4"L x 2 1/4"W
 Matte Black pictured with
 1 1/8" modern collar
 and TFCM118 pole



TFCM601/CL NEW
Declan Acrylic
 2 1/4"L x 2 1/4"W
 pictured with
 1 3/8" transitional collar
 and TFCM138 pole
 in Acrylic



TFCM602 NEW
Upton
 4"L x 1 7/8"W
 Brushed Nickel
 pictured with
 1 1/8" modern cuff
 and TFCM118 pole



TFCM602/CL NEW
Upton Acrylic
 4"L x 1 7/8"W
 pictured with
 1 1/8" modern collar
 and TFCM118 pole
 in Brushed Nickel



TFCM603 NEW
Delano
 4"L x 1 7/8"W
 Brushed Black Nickel
 pictured with
 1 1/8" modern cuff
 and TFCM118 pole



TFCM604 NEW
Mercer
 4"L x 2 1/8"W
 Satin Gold pictured with
 1 3/8" transitional collar
 and TFCM138 pole



TFCM605 NEW
Luca
 2"L x 3 3/4"W
 Acrylic pictured with
 1 1/8" transitional collar
 and TFCM118 pole
 in Chrome



TFCM606 NEW
Stiles
 2 3/8"L x 3"W
 Acrylic pictured with
 1 3/8" modern collar
 and TFCM138 pole
 in Matte Black

1 1/8" - 1 3/8" modern metal



TFCM691 NEW
Anson
 7/8" L x 3" W
 Chrome pictured with
 1 1/8" transitional collar
 and TFCM118 pole



TFCM691/CL NEW
Anson Acrylic
 7/8" L x 3" W
 pictured with
 1 1/8" modern cuff
 and TFCM118 pole
 in Matte Black

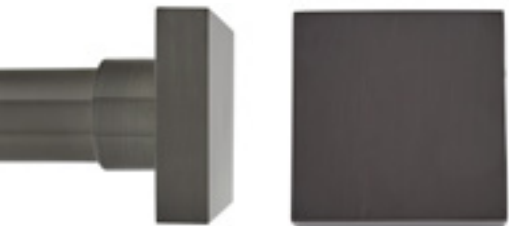

TFCM692 NEW
Eason
 1" L x 2 7/8" W
 Brushed Black Nickel
 pictured with
 1 3/8" modern cuff
 and TFCM138 pole



TFCM692/CL NEW
Eason Acrylic
 1" L x 2 7/8" W
 pictured with
 1 3/8" modern collar
 and TFCM138 pole
 in Satin Gold



TFCM118690 NEW
Bex 1 1/8" End Cap
 3/4" L x 1 3/8" W
 Satin Gold pictured with
 TFCM118 pole

TFCM138690 NEW
Bex 1 3/8" End Cap
 1" L x 1 5/8" W

Bex End Caps do not require a cuff or collar.

cuffs & collars

Modern Collection finials are designed to coordinate with both 1 1/8" and 1 3/8" cuffs and collars. Please select a cuff or collar to match your selected pole diameter.



TFCM118800 NEW
 1 1/8" metal modern cuff
 1" L x 1 3/8" W

TFCM138800 NEW
 1 3/8" metal modern cuff
 1" L x 1 5/8" W



TFCM118801 NEW
 1 1/8" metal modern collar
 1 5/8" L x 1 3/8" W

TFCM138801 NEW
 1 3/8" metal modern collar
 1 5/8" L x 1 5/8" W



TFCM118802 NEW
 1 1/8" metal transitional collar
 1 5/8" L x 1 3/8" W

TFCM138802 NEW
 1 3/8" metal transitional collar
 1 7/8" L x 1 5/8" W

Finishes can be mixed and matched to create unique style combinations.



Luca acrylic finial shown with 1 3/8" metal transitional collar in Satin Gold and TFCM138 acrylic pole.

Cuffs and collars are available in all modern finishes on page 9. Sold separately.

brackets

1 1/8" - 1 3/8"
modern metal



TFCM118420 **NEW**
1 1/8" metal bracket, single
3 1/2" return, 2" Dia backplate

TFCM138420 **NEW**
1 3/8" metal bracket, single
3 1/2" return, 2 1/2" Dia backplate

TFCM118420L **NEW**
1 1/8" metal bracket, single
6" return, 2" Dia backplate

TFCM138420L **NEW**
1 3/8" metal bracket, single
6" return, 2 1/2" Dia backplate



TFCM118424 **NEW**
1 1/8" metal bracket, double
6 1/2" front and 3 1/2" back return,
2" Dia backplate

TFCM138424 **NEW**
1 3/8" metal bracket, double
6 1/2" front and 3 1/2" back return,
2 1/2" Dia backplate



TFCM118428 **NEW**
1 1/8" bypass bracket, single
3 1/2" return, 2" Dia backplate

TFCM138428 **NEW**
1 3/8" bypass bracket, single
3 1/2" return, 2 1/2" Dia backplate



TFCM118426 **NEW**
1 1/8" eyelet bracket, single
3 1/2" return, 2" Dia backplate

TFCM138426 **NEW**
1 3/8" eyelet bracket, single
3 1/2" return, 2 1/2" Dia backplate

TFCM118427 **NEW**
1 1/8" eyelet bracket, single
6" return, 2" Dia backplate

TFCM138427 **NEW**
1 3/8" eyelet bracket, single
6" return, 2 1/2" Dia backplate



TFCM118429 **NEW**
1 1/8" eyelet bracket, double
6" front and 3 1/2" back return,
2" Dia backplate

TFCM138429 **NEW**
1 3/8" eyelet bracket, double
6" front and 3 1/2" back return,
2 1/2" Dia backplate



TFCM118401 **NEW**
1 1/8" inside mount brackets, 2pc
1 3/4"W, 1 3/4" backplate, 1 1/4" deep,
(sold in pairs)

TFCM138401 **NEW**
1 3/8" inside mount brackets, 2pc
2"W, 2" backplate, 1 3/8" deep,
(sold in pairs)



TFCM118402 **NEW**
1 1/8" hinged elbow
1 3/4"L (1 1/2" each side when bent),
1 1/8" base

TFCM138402 **NEW**
1 3/8" hinged elbow
2"L (1 3/4" each side when bent),
1 3/8" base

Brackets shown in BBN Brushed Black Nickel.

1 1/8" - 1 3/8" modern metal

poles

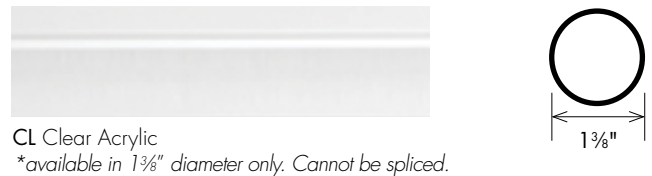

pole lengths

1 1/8" diameter poles

- TFCM118002 - 2' **NEW**
- TFCM118004 - 4' **NEW**
- TFCM118006 - 6' **NEW**
- TFCM118008 - 8' **NEW**
- TFCM118010 - 10' **NEW**
- TFCM118012 - 12' **NEW**

1 3/8" diameter poles

- TFCM138002 - 2' **NEW**
- TFCM138004 - 4' **NEW**
- TFCM138006 - 6' **NEW**
- TFCM138008 - 8' **NEW**
- TFCM138010 - 10' **NEW**
- TFCM138012 - 12' **NEW**



TFCM118403 **NEW**
1 1/8" pole splice



TFCM138403 **NEW**
1 3/8" pole splice

Modern metal poles are sold in 2 foot increments, 2 foot minimum.
Poles will be cut to specified length. Fall off will not be saved or shipped.

rings



TFCM118205 **NEW**
1 1/8" metal ring
1 5/8"ID, 2 1/8"OD



TFCM118207 **NEW**
1 1/8" metal c-ring
1 5/8"ID, 2 1/8"OD

TFCM138205 **NEW**
1 3/8" metal ring
2"ID, 2 3/8"OD

TFCM138207 **NEW**
1 3/8" metal c-ring
2"ID, 2 3/8"OD

Rings include plastic inserts for smooth gliding and to prevent abrasion on poles. Rings shown in BBN Brushed Black Nickel.

tiebacks



TFCM991 **NEW**
metal tieback base
2 1/2" projection, 2 3/8" Dia backplate



TFCM990 **NEW**
metal tieback extension
2"L

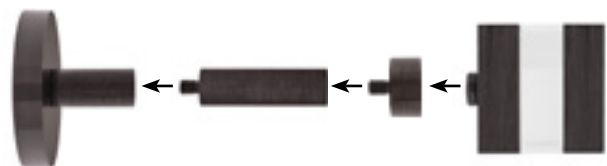

Can be used with any modern metal collection finial.

accessories

1 1/8" - 1 3/8"
modern metal



- A TFCM312S **NEW**
metal baton
3/8" Dia, available in 36"
- TFCM314S **NEW**
metal baton
3/8" Dia, available in 48"
- TFCM316S **NEW**
metal baton
3/8" Dia, available in 60"
- B ABTN-36 **NEW**
clear acrylic baton
5/8" Dia, available in 36"
- ABTN-48 **NEW**
clear acrylic baton
5/8" Dia, available in 48"

CH BN SG BBN MK
A B

finishes



CH Chrome



BN Brushed Nickel



SG Satin Gold



BBN Brushed Black Nickel

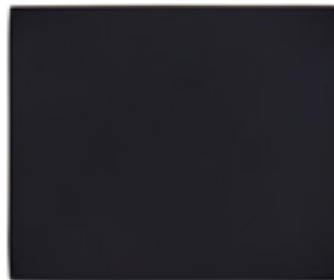

MK Matte Black



1³/₈" metal collection

Inspired by a modern interpretation of classic and transitional silhouettes, our 1³/₈" Metal Collection blends unique custom quality design details with 8 beautifully layered plated finishes. For a unique finishing touch, you can now customize your metal hardware design by selecting from any of our 50 hand painted finishes.



TFCM138100 **NEW**
Turner
5"L x 3"W
Antique Pewter
pictured with TFCM138 pole



TFCM138101 **NEW**
Britton
3 1/4"L x 3 7/8"W
Venetian Bronze
pictured with TFCM138 pole
in Matte Black



TFCM138102 **NEW**
Ashby
3 7/8"L x 3 3/8"W
Dark Oil Rubbed Bronze
pictured with TFCM138 pole
in Matte Black



TFCM138103 **NEW**
Abington
4 3/8"L x 3 1/4"W
Brushed Bronze
pictured with TFCM138 pole



TFCM138104 **NEW**
Harlow
4 3/8"L x 3"W
Antique Brass
pictured with TFCM138 pole



TFCM138105 **NEW**
Weston
4 1/4"L x 3 1/8"W
Polished Nickel
pictured with TFCM138 pole



TFCM138106 **NEW**
Brentford
3 5/8"L x 3 1/4"W
Venetian Bronze
pictured with TFCM138 pole
in Matte Black



TFCM138107 **NEW**
Rothwell
4 1/8"L x 3"W
Oil Rubbed Bronze
pictured with TFCM138 pole



TFCM138190 **NEW**
Wells End Cap
1 1/4"L x 2 1/4"W
Satin Black
pictured with TFCM138 pole

custom solutions: hand painted finishes

Our 1 3/8" metal collection is now available in any of our 50 beautifully hand painted finishes located on the back cover. Please see the Retail Price List for custom finish options and surcharges.

1 3/8"
metal

brackets



TFCM138400 **NEW**
metal bracket, single
3 1/2" - 4 1/2" return, 2" Dia backplate



TFCM138404 **NEW**
metal bracket, double
6" front and 3 1/2" back return,
2" Dia backplate



TFCM138408 **NEW**
bypass bracket, single
3 1/2" - 4 1/2" return, 2" Dia backplate

TFCM138400L **NEW**
metal bracket, single
5" - 6 1/2" return, 2" Dia backplate



TFCM138406 **NEW**
eyelet bracket, single
3 1/2" return, 2" Dia backplate



TFCM138401 **NEW**
1 3/8" inside mount brackets, 2pc
2" W, 2" backplate, 1 3/8" deep,
(sold in pairs)
shown in MK Matte Black



TFCM138402 **NEW**
1 3/8" hinged elbow
2" L (1 3/4" each side when bent),
1 3/8" base
shown in MK Matte Black

Brackets shown in VZ Venetian Bronze.

rings



TFCM138200 **NEW**
metal ring
2" ID, 2 3/8" OD



TFCM138201 **NEW**
metal c-ring
2" ID, 2 3/8" OD

Rings include plastic inserts for smooth gliding and to prevent abrasion on poles. MK rings coordinate with VZ and DRB finishes. Rings shown in MK Matte Black.

tiebacks



TFCM138310 **NEW**
1 5/8" projection, 1 3/8" Dia
finial wall mount adaptor turns any finial into a tieback.
use with any 1 3/8" metal collection finial.

Tieback shown in MK Matte Black with VZ Venetian Bronze finial.

poles



PN Polished Nickel



AB Antique Brass



ORB Oil Rubbed Bronze

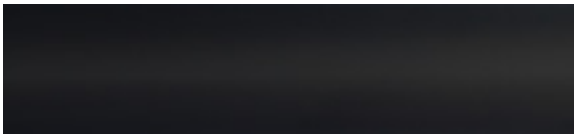

MK Matte Black coordinates with VZ Venetian Bronze & DRB Dark Oil Rubbed Bronze



AP Antique Pewter



BZ Brushed Bronze



SK Satin Black



SF Standard Finish - finish options available on the back cover.

pole lengths

1 3/8" diameter poles

TFCM138202 - 2' **NEW**

TFCM138204 - 4' **NEW**

TFCM138206 - 6' **NEW**

TFCM138208 - 8' **NEW**

TFCM138210 - 10' **NEW**

TFCM138212 - 12' **NEW**



TFCM138403 **NEW**
1 3/8" pole splice

Continuous 10' & 12' poles not available in BZ or ORB finishes.

Metal poles are sold in 2 foot increments, 2 foot minimum. Poles will be cut to specified length. Fall off will not be saved or shipped.

accessories



PN AP AB BZ ORB SK MK

A

B

A TFCM312S **NEW**
metal baton
3/8" Dia, available in 36"

TFCM314S **NEW**
metal baton
3/8" Dia, available in 48"

TFCM316S **NEW**
metal baton
3/8" Dia, available in 60"

B ABTN-36 **NEW**
clear acrylic baton
3/8" Dia, available in 36"

ABTN-48 **NEW**
clear acrylic baton
3/8" Dia, available in 48"



finishes

Our 1³/₈" metal collection is now available in any of our 50 beautifully hand painted finishes located on the back cover, as well as in the 8 plated finish options shown below. Please see the Retail Price List for custom finish options and surcharges.



PN Polished Nickel



AP Antique Pewter



AB Antique Brass



BZ Brushed Bronze



ORB Oil Rubbed Bronze



VZ Venetian Bronze



DRB Dark Oil Rubbed Bronze



SK Satin Black



1/2"

3/4"

1"

1 1/4"

1 1/2" - 1 3/4"

steel

1/2" collection	15
3/4" collection	18
1" collection	25
1 1/4" collection	32
1 1/2" - 1 3/4" collection	39
outdoor hardware	45

actual pole sizes

1/2"

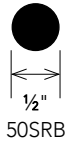
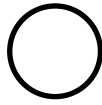

3/4"

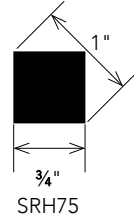
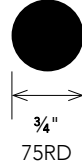
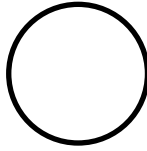

1"

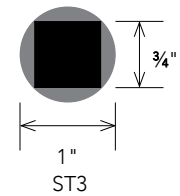
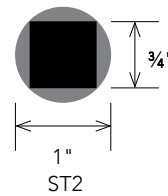
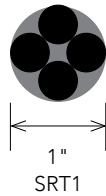
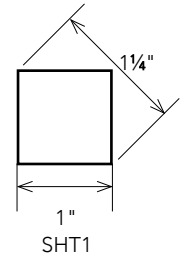
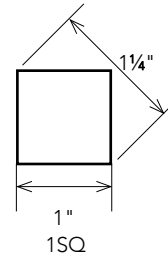
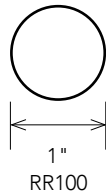
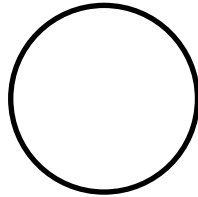

1 1/4"

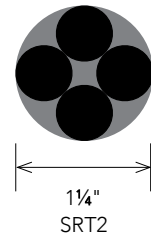
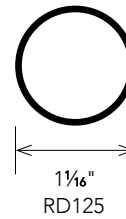
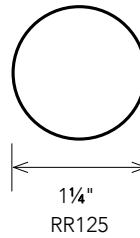
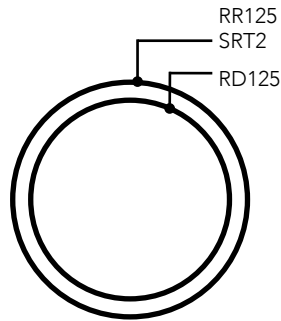

1 1/2" - 1 3/4"

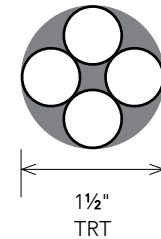
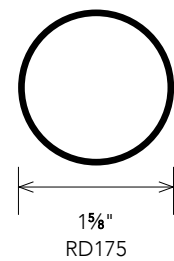
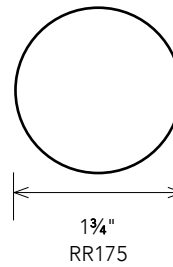
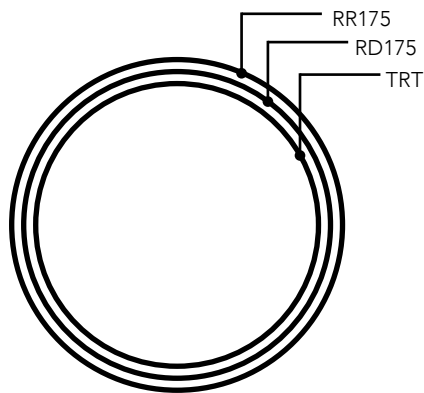



1/2" steel

The Finial Company's signature steel collection features cast and forged finials, brackets, poles and rings available in our 50 standard hand painted finishes; and has been updated to include an assortment of modern finial styles and design details that appeal to today's aesthetic. The 1/2" steel collection is ideal for French doors and smaller kitchen or bathroom windows designed to be covered with sheer to light weight window treatments.



TFCS034110 NEW
 1 5/8"L x 1 5/8"W, 1" base
 860 Grayed Brass
 pictured with pole 50SRB



F050-3
 7/8"L x 1"W, 7/8" base
 630 Ash Gray
 pictured with pole 50SRB



F050-1C
 crystal finial
 1 1/2"L x 1 3/8"W, 7/8" base
 690 Champagne
 pictured with pole 50SRB,



F050-1S
 1 1/2"L x 1 3/8"W, 7/8" base
 660 Antique White
 pictured with pole 50SRB



F050-2C
 crystal finial
 1 5/8"L x 1 1/2"W (1 1/8"Sq), 7/8" base
 620 Weathered Iron
 pictured with pole 50SRB,



SF37
 1"L x 1"W
 600 Gilded Red
 pictured with pole 50SRB



SF35
 1"L x 1"W
 105 Bronze
 pictured with pole 50SRB



S93
 1 3/4"L x 1 1/4"W, 1" base
 320 Pewter
 pictured with pole 50SRB in
 109 Flat Black



EC4
 7/8"L x 1 1/4"W
 150 Gray with Gold
 pictured with pole 50SRB



F050-2S
 1 5/8"L x 1 1/2"W (1 1/8"Sq), 7/8" base
 640 Oil Rubbed Bronze
 pictured with pole 50SRB

brackets

standard



BKT050-1
adjustable steel bracket, single
2½"-3½" return, ½"W x 2"L backplate



BKT050-4 **NEW**
steel bracket, single
1" return, ½"W x 1¼"L backplate



BKT050-3
steel bracket, single
6" return, ½"W x 1¼"L backplate



BKT050-2
steel bracket, double
6" front and 3" back return,
½"W x 2½"L backplate



IMB050-1
½" steel inside mount brackets
1"H x ¾"W backplate, ¾"Deep,
⅛" thick backplate per bracket
(sold in pairs)



75ELB **NEW**
¾" hinged elbow
2½"L, (1½"L each side when bent),
⅞" base

Return distance is from wall to center of cradle.
Standard brackets shown in 680 Aged Gold.

1/2"
steel

custom solutions: brackets

Not seeing the bracket you need?

Check out our custom bracket and hardware solutions on page 56.

rings



SR05
smooth steel ring
¾"D, 1½"OD

Ring shown in 680 Aged Gold.

poles



50SRB
steel pole, ½"Dia round solid pole
maximum length is 240 inches



½" steel poles are sold in 1 foot increments, 2 foot minimum. Poles will be cut to specified length. Fall off will not be saved or shipped. Poles shown in 860 Grayed Brass.

accessories



- A SBTN**
steel baton, specify finish
¾"Dia
specify length up to 60"
- SBTN60**
specify length up to 96"
- B FBTN**
fiberglass baton, white
¾"Dia
specify length up to 48"
- C ABTN-36** **NEW**
clear acrylic baton
¾"Dia, available in 36"
- ABTN-48** **NEW**
clear acrylic baton
¾"Dia, available in 48"



$\frac{3}{4}$ " steel

Our $\frac{3}{4}$ " steel collection features finials in classic and traditional architectural shapes that can be hand painted for a custom design that reflects a range of home décor styles. Our ability to customize nearly any steel item guarantees that you can create a unique design for your window treatment.



TFC034110 **NEW**
1 5/8"L x 1 5/8"W, 1" base
810 Bronzed Ore
pictured with pole 75RD



SEC-125 **OH**
1/4"L x 1 1/3"W, 1 1/3" base
680 Aged Gold
pictured with pole 75RD



EC4
7/8"L x 1 1/4"W
150 Gray with Gold
pictured with pole 75RD



SF36
1 1/4"L x 1 1/4"W
105 Bronze
pictured with pole 75RD



S93
1 3/4"L x 1 1/4"W, 1" base
320 Pewter
pictured with pole 75HSRB



SF202A
1 5/8"L x 1 5/8"W
750 Polished Gold
pictured with pole 75RD



SF202B
2"L x 2"W
640 Oil Rubbed Bronze
pictured with pole 75HSRB



SF3
2 1/4"L x 1 5/8"W, 1 1/4" base
129 Antique Steel
pictured with pole 75RD



SF180
3 7/8"L x 2"W, 1 3/4" base
710 Tarnished Silver
pictured with pole 75RD



SF-1
3 3/8"L x 2 3/8"W, 1 5/8" base
610 Cobalt Bronze
pictured with pole 75HSRB

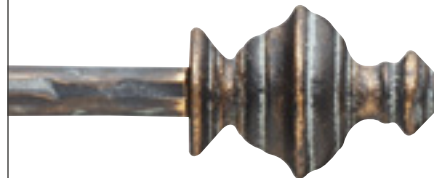

SF69
3 1/2"L x 2 1/2"W, 1 3/4" base
620 Weathered Iron
pictured with pole 75HSRB



SF133
2"L x 2 3/8"W, 1 1/4" Sq base
690 Champagne
pictured with pole SRH75



L651
5 1/8"L x 3 7/8"W, 1" base
110 Flat Black with Gold
pictured with pole 75RD



SF201
2 3/4"L x 1 5/8"W, 1 1/4" Sq base
630 Ash Gray
pictured with pole SRH75

custom solutions: did you know?



Our custom solutions shop can add a rosette to the front of any bracket. For more ideas on how to customize your steel brackets, turn to page 57 in Custom Solutions.



Did you know we can add a bent return to your 3/4" solid 75RD and 75HSRB poles? To find out more about bends and miters for all poles, turn to page 50 in Custom Solutions.

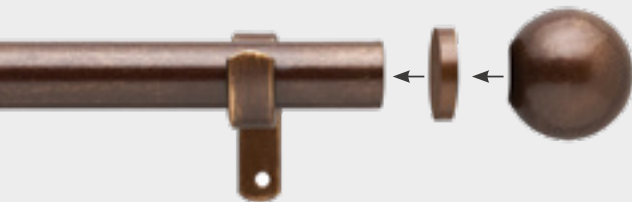

Do you wish your 3/4" finial could fit a larger pole diameter? It can with the addition of a finial adaptor. See page 58 for more options.



SF135
2"L x 2"W, 1 3/8" base
250 Platinum
pictured with pole 75RD

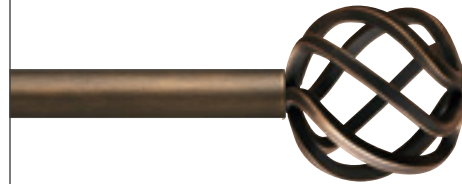

SF158B7
3"L x 2 3/4"W
106 Bronze with Gold
pictured with pole 75RD



SF236
3 1/4"L x 3"W, 1 3/8" base
250B Platinum with
Black Highlights
pictured with pole 75RD



K657
4"L x 2"W, 1 3/4" base
110 Flat Black with Gold
pictured with pole 75RD



L885875
5 3/4"L x 3 3/4"W,
1 1/2" base
107 Bronze with Gold
and Gray
pictured with pole SRH75



Branch with Leaf
14"L x 10"W
please specify right (shown) or left
270 Mahogany Rust with
custom green on leaves
pictured with pole 75RD

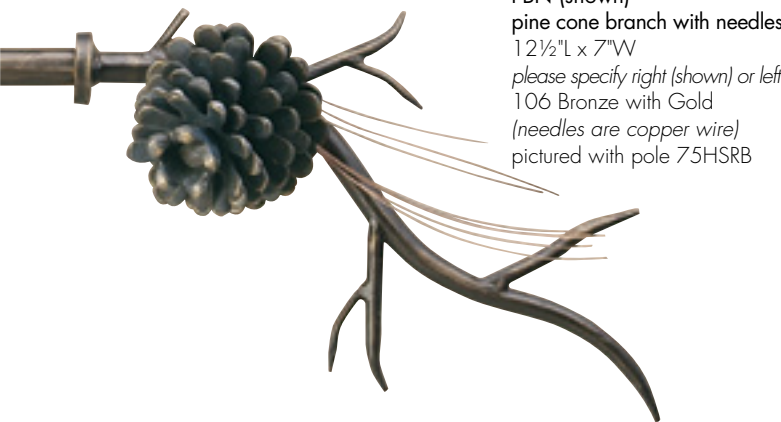

PBN (shown)
pine cone branch with needles
12 1/2"L x 7"W
please specify right (shown) or left
106 Bronze with Gold
(needles are copper wire)
pictured with pole 75HSRB

PB (not shown)
pine cone branch (no needles)
12 1/2"L x 7"W
please specify right or left



BIRD
single bird on branch
14"L x 11 1/2"W
please specify right (shown) or left
270 Mahogany Rust with
custom green on leaves
pictured with pole 75RD



L848 **OH**
7 1/2"L x 4 1/4"W, 1" base
110 Flat Black with Gold
pictured with pole 75RD



SF19
3 1/2"L x 6 3/4"W, 1 3/8" base
680 Aged Gold
pictured with pole 75RD

brackets

standard



BKT075-100
adjustable steel bracket, single
3½"-5" return, 1"W x 3"L backplate



L125100
steel bracket, single
2" return, ¾"W x 2½"L backplate



TFCS100LASBK **NEW**
steel bracket, single
3½" return, ¾"W x 3¾"L backplate



TFCS100LADBK **NEW**
steel bracket, double
6" front and 3" back return,
¾"W x 3¾"L backplate

L135100
steel bracket, single
3⅝" return, ¾"W x 2½"L backplate

TFCS100LAS6BK **NEW**
steel bracket, single
6" return, ¾"W x 3¾"L backplate



EB1
steel eyelet bracket, single
3½" return, 1"W x 3½"L
backplate, eyelet 1"ID



L125-SQ
steel square bracket, single
2½" return, ¾"W x 2½"L backplate



TFCS100MCMBK **NEW**
1" steel ceiling mount bracket
2" Dia ceiling plate, 2¼"H
2⅛" drop (distance from ceiling
to bottom of pole)



TFCS100MIBK **NEW**
1" steel inside mount brackets
1⅞"H x 1⅜"W backplate, ¾" Deep,
⅝" thick backplate per bracket
(sold in pairs)

EB2
steel eyelet bracket, single
6" return, 1"W x 3½"L
backplate, eyelet 1"ID

L135-SQ
steel square bracket, single
3½" return, ¾"W x 2½"L backplate
*note: square brackets above are to be
used with SRH75 square pole*



75ELB **NEW**
¾" hinged elbow
2½"L, (1⅜"L each side when bent),
⅞" base

*Return distance is from wall to center of cradle.
Standard brackets shown in 680 Aged Gold.*

custom solutions: bypass brackets

CAUTION: Bypass Brackets do not have full cradles. Standard brackets must be installed at each end to secure ¾" pole.

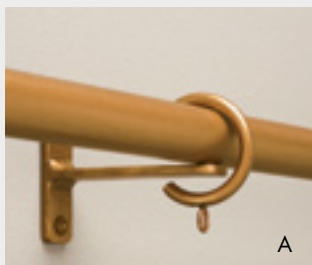

A

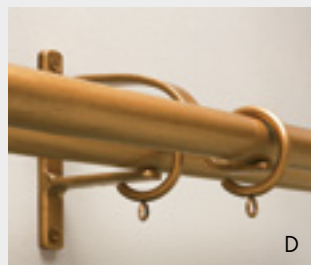

D

A. SCB35
steel custom bypass bracket, single
3½" return, ¾"W backplate x 2½"
or 3"L

B. SCB6
steel custom bypass bracket, single
6" return, ¾"W backplate x 2½"
or 3"L

C. SCBC
steel custom bypass bracket, single
custom return, ¾"W backplate
x 2½" or 3"L

D. SCBCDBL
steel custom bypass bracket, double
custom return, ¾"W backplate
x 5¼"L

Use with 75RD pole and CR-SR75 c-ring. For more bypass bracket information, see page 56.

custom solutions: brackets

The Finial Company is known for quality craftsmanship and can create custom brackets to match your job specifications. We can customize bracket dimensions, returns and finish on any pole for a custom fit on every job. For more custom solutions products see our custom brackets section on page 56.



TBKT
custom steel t-bracket, single
please specify:
A. return (distance from wall to center of cradle)
B. pole size and profile
note: 3½"H backplate comes standard, unless otherwise specified



DBL1
custom steel bracket, double
please specify:
A. front pole size and profile
B. back pole size and profile
C. rings to be used, if any
D. front and back returns (distance from wall to center of cradle)
note: returns are contingent upon which poles and rings are chosen
3½"H backplate comes standard, unless otherwise specified



BL4
custom steel ceiling mount bracket
please specify:
A. drop (distance from ceiling to top of pole)
B. pole size and profile
C. rings to be used, if any
note: minimum drop is contingent upon which finial and ring are chosen
2½"W backplate comes standard, unless otherwise specified



FBKT
custom steel bracket, single
please specify:
A. return (distance from wall to center of cradle)
B. pole size and profile
note: 4¾"H backplate may not be modified

Return or drop distance in excess of 8" on any custom bracket will incur additional fees and requires addition of support arm. Custom brackets are shown unfinished, but will be hand painted in your selected Standard Finish (see back cover) or for a custom finish you can send us a finish sample and we'll prepare a strike-off sample for approval (see Retail Price List for custom finish charges).

rings



SR1
smooth steel ring
1"ID, 1½"OD



SQRG1
smooth square steel ring
1½"ID, 2½"OD



CR-SR75 NEW
smooth steel c-ring
1¼"ID, 1¾"OD
use with 75RD pole and SCB35, SCB6, SCBC or SCBCDBL bypass brackets

3/4"
steel

custom solutions: french returns

Our custom metal shop can create custom bent and mitered pole returns for any window. For more details, see pages 50–53 in the Custom Solutions section.



poles



75RD
3/4" Dia solid steel pole, round
maximum length is 220 inches

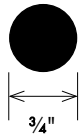

75HSRB
3/4" Dia hammered solid steel pole, round
maximum length is 115 inches

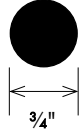

SRH75
3/4" Sq hammered solid steel pole, square
maximum length is 228 inches

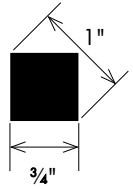

3/4" steel poles are sold in 1 foot increments, 2 foot minimum. Poles will be cut to specified length. Fall off will not be saved or shipped. Poles shown in 860 Grayed Brass.

accessories



- A SBTN**
steel baton, specify finish
3/8" Dia
specify length up to 60"
SBTN60
specify length up to 96"
- B FBTN**
fiberglass baton, white
3/8" Dia
specify length up to 48"
- C ABTN-36** **NEW**
clear acrylic baton
3/8" Dia, available in 36"
ABTN-48 **NEW**
clear acrylic baton
3/8" Dia, available in 48"



1" steel

Our most popular diameter in the steel category, the 1" steel collection features the largest selection of quality crafted finial designs and pole styles including round, square, hammered and twisted options to create the perfect window hardware solution for a well-designed room. The six new finial designs feature cleaner profiles and glass options to reflect a more modern aesthetic.

1" steel



TFCS114111 **NEW**
1¾"L x 1⅞"W, 1⅝"Sq base
850 Soft Brass
pictured with pole 1SQ



TFCS114120 **NEW**
1⅞"L x 2¼"W, 1¾" base
860 Grayed Brass
pictured with pole ST2



TFCS114190 **NEW**
1⅞"L x 2¼"W, 1⅝" base
830 Driftwood
pictured with pole RR100



TFCS114110 **NEW**
1⅞"L x 2⅜"W, 1⅝" base
820 Sea Salt Black
pictured with pole 1SQ



TFCS114170 **NEW**
glass finial
2⅞"L x 2⅜"W, 1⅝" base
810 Bronzed Ore
pictured with pole RR100



TFCS114171 **NEW**
glass finial
3⅞"L x 2⅞"W, 1⅝" base
800 Charred Toasted Oak
pictured with pole RR100



SEC-125 **OH**
¼"L x 1⅓"W, 1⅓" base
105 Bronze
pictured with pole RR100
*not for use with square pole
1SQ or SHT1*



SF201
2¾"L x 1⅝"W, 1¼"Sq base
630 Ash Gray
pictured with pole SHT1



SQEC
¼"L x 1⅞"W, 1⅝"Sq base
109 Flat Black
pictured with pole 1SQ
*finial only fits 1SQ &
SHT1 poles*



SF230
2¼"L x 2"W, 1⅞" base
700 Graphite
pictured with pole ST3



SF202A
1⅝"L x 1⅝"W
150 Gray with Gold
pictured with pole RR100



SF202B
2"L x 2"W
640 Oil Rubbed Bronze
pictured with pole RR100



EC135 **OH**
1¼"L x 2⅞"W, 2" base
110 Flat Black with Gold
pictured with pole RR100



SF180
3⅞"L x 2"W, 1¾" base
730 Rose Gold
pictured with pole SRT1



SF237
2⅞"L x 1⅝"W, 1⅞" base
100 Polished Steel
pictured with pole ST3

**please note: there is an
upcharge for this custom
finish; please refer to Retail
Price List for details.*



SF69
3½"L x 2½"W, 1¾" base
330 Bronze with Black
pictured with pole SRT1



SF133
2"L x 2³/₈"W, 1¹/₄"Sq base
680 Aged Gold
pictured with pole 1SQ



L9328
2"L x 2"W
106 Bronze with Gold
pictured with pole RR100



L9328B
2³/₄"L x 2"W, 1³/₈" base
117 Walnut Gold
pictured with pole RR100



SF135
2"L x 2"W, 1³/₈" base
250 Platinum
pictured with pole RR100



K657
4"L x 2"W, 1³/₄" base
110 Flat Black with Gold
pictured with pole RR100



SF45
3"L x 2¹/₂"W, 1⁵/₈" base
110 Flat Black with Gold
pictured with pole RR100



SF236
3¹/₄"L x 3"W, 1⁵/₈" base
250B Platinum with Black
pictured with pole RR100



4519C OH
3¹/₂"L x 2³/₄"W, 1³/₄" base
106 Bronze with Gold
pictured with pole RR100



SF-1
3³/₈"L x 2³/₈"W, 1⁵/₈" base
126 Dark Walnut Gloss
with Gold
pictured with pole ST3

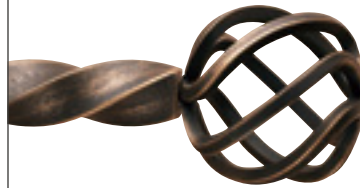

SF158B7
3"L x 2³/₄"W
106 Bronze with Gold
pictured with pole ST3



L885875
5³/₄"L x 3³/₄"W, 1¹/₂"Sq base
107 Bronze with Gold and
Gray pictured with pole SHT1



L651
5¹/₈"L x 3³/₈"W, 1" base
110 Flat Black with Gold
pictured with pole RR100



L848 OH
7¹/₂"L x 4¹/₄"W, 1" base
110 Flat Black with Gold
pictured with pole RR100



SF132
4¹/₄"L x 4³/₄"W, 2" base
350G Statuary Bronze
with Gold
pictured with pole RR100

1"
steel



Branch with Leaf
14"L x 10"W
please specify right (shown) or left
270 Mahogany Rust with
custom green on leaves
pictured with pole 75RD

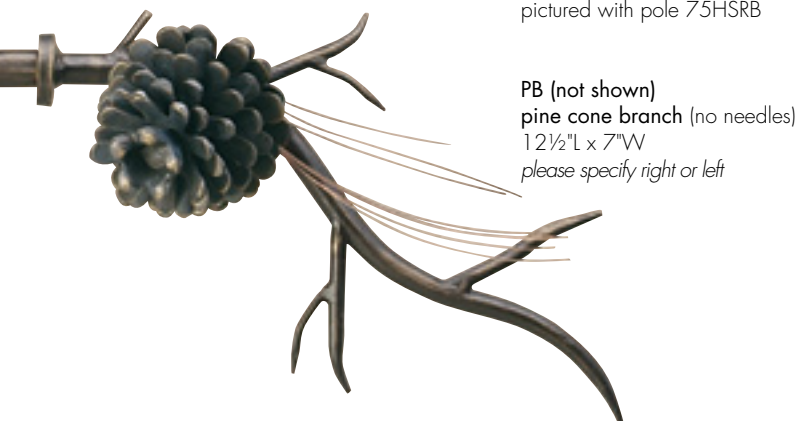

PBN (shown)
pine cone branch with needles
12½"L x 7"W
please specify right (shown) or left
106 Bronze with Gold
(needles are copper wire)
pictured with pole 75HSRB



PB (not shown)
pine cone branch (no needles)
12½"L x 7"W
please specify right or left



BIRD
single bird on branch
14"L x 11½"W
please specify right (shown) or left
270 Mahogany Rust with
custom green on leaves
pictured with pole 75RD

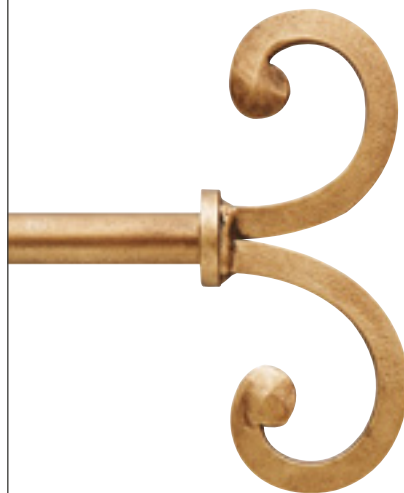

SF19
3½"L x 6¾"W, 1⅜" base
680 Aged Gold
pictured with pole 75RD

brackets

1"
steel

standard



BKT075-100
adjustable steel bracket, single
3½"-5" return, 1"W x 3"L backplate



L125100
steel bracket, single
2" return, ¾"W x 2½"L backplate



TFCS100LASBK **NEW**
steel bracket, single
3½" return, ¾"W x 3¾"L backplate



TFCS100LADBK **NEW**
steel bracket, double
6" front and 3" back return,
¾"W x 3¾"L backplate

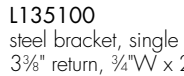

L135100
steel bracket, single
3½" return, ¾"W x 2½"L backplate

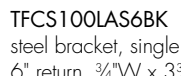

TFCS100LAS6BK **NEW**
steel bracket, single
6" return, ¾"W x 3¾"L backplate



TFCS100GRSBK **NEW**
steel bypass bracket, single
3½" return, ¾"W x 3¾"L
backplate
use with RR100 pole and
TFCS100SCR1 c-ring



TFCS100GRDBK **NEW**
steel bypass bracket, double
6" front and 3" back return,
¾"W x 3¾"L backplate
use with RR100 pole and
TFCS100SCR1 c-ring



L125-SQ
steel square bracket, single
2½" return, ¾"W x 2½"L backplate



TFCS100MCMBK **NEW**
1" steel ceiling mount bracket
2" Dia ceiling plate, 2¼"H,
2⅝" drop (distance from ceiling
to bottom of pole)

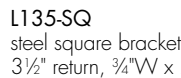

L135-SQ
steel square bracket, single
3½" return, ¾"W x 2½"L backplate

*note: square brackets above are to be
used with 1SQ and SHT1 square poles*



TFCS100MBK **NEW**
1" steel inside mount brackets
1⅝"H x 1⅜"W backplate, ¾"Deep,
⅝" thick backplate per bracket
(sold in pairs)



TFCR100REL **NEW**
1" hinged elbow
3¼"L, (2⅝"L each side when bent),
1⅝" base

*Return distance is from wall to center of cradle.
Standard brackets shown in 680 Aged Gold.*

custom solutions: bypass brackets

CAUTION: Bypass Brackets do not have full cradles. Standard brackets must be installed at each end to secure 1" pole.

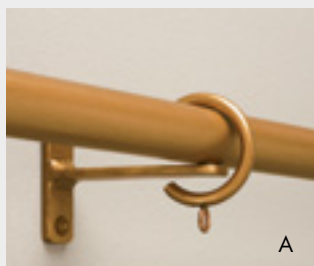

A

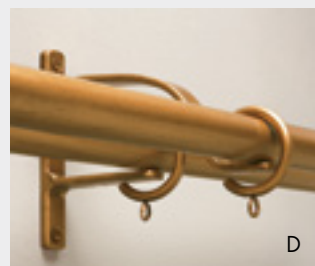

D

A. SCB35
steel custom bypass bracket, single
3½" return, ¾"W backplate
x 2½" or 3"L

B. SCB6
steel custom bypass bracket, single
6" return, ¾"W backplate
x 2½" or 3"L

C. SCBC
steel custom bypass bracket, single
custom return, ¾"W backplate
x 2½" or 3"L

D. SCBCDBL
steel custom bypass bracket, double
custom return, ¾"W backplate
x 5¼"L

Use with RR100 pole and CR-SR3 c-ring. For more bypass bracket
information, see page 56.

custom solutions: brackets

The Finial Company is known for quality craftsmanship and can create custom brackets to match your job specifications. We can customize bracket dimensions, returns and finish on any pole for a custom fit on every job. For more custom solutions products see our custom brackets section on page 56.



TBKT
custom steel t-bracket, single
please specify:
A. return (distance from wall to center of cradle)
B. pole size and profile
note: 3½"H backplate comes standard, unless otherwise specified



DBL1
custom steel bracket, double
please specify:
A. front pole size and profile
B. back pole size and profile
C. rings to be used, if any
D. front and back returns (distance from wall to center of cradle)
note: returns are contingent upon which poles and rings are chosen
3½"H backplate comes standard, unless otherwise specified



BL4
custom steel ceiling mount bracket
please specify:
A. drop (distance from ceiling to top of pole)
B. pole size and profile
C. rings to be used, if any
note: minimum drop is contingent upon which finial and ring are chosen
2½"W backplate comes standard, unless otherwise specified



FBKT
custom steel bracket, single
please specify:
A. return (distance from wall to center of cradle)
B. pole size and profile
note: 4¾"H backplate may not be modified

Return or drop distance in excess of 8" on any custom bracket will incur additional fees and requires addition of support arm. Custom brackets are shown unfinished, but will be hand painted in your selected Standard Finish (see back cover) or for a custom finish you can send us a finish sample and we'll prepare a strike-off sample for approval (see Retail Price List for custom finish charges).

rings



SR3
smooth steel ring
1½"ID, 2"OD



FSR1
smooth heavy steel ring
1¾"ID, 2¾"OD



SQRG1
smooth square steel ring
1½"ID, 2½"OD



CR-SR3
smooth steel c-ring
1½"ID x 2"OD
use with RR100 pole and SCB35, SCB6, SCBC or SCBCDBL bypass brackets



TFCS100SCRI NEW
smooth steel c-ring
1½"ID, 2"OD
use with RR100 pole and TFCS100GRSBK or TFCS100GRDBK bypass brackets

Rings shown in 680 Aged Gold.

poles

1"
steel



RR100
1" round tube
maximum length is 192 inches

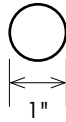

1SQ
1" smooth square tube
maximum length is 288 inches; use with L125-SQ,
L135-SQ brackets, SQRG1 ring

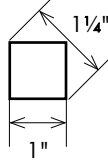

SHT1
1" square hammered tube
maximum length is 228 inches; use with L125-SQ,
L135-SQ brackets, SQRG1 ring

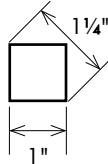

SRT1
1" solid rope twist pole
maximum length is 228 inches; use ring with minimum
1 1/2" ID

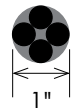

ST2
1" single twist solid steel pole
maximum length is 228 inches; use ring with minimum
1 1/2" ID

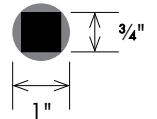

ST3
1" double twist solid steel pole
maximum length is 228 inches; use ring with minimum
1 1/2" ID

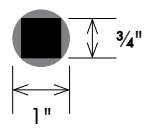

1" steel poles are sold in 1 foot increments, 2 foot minimum. Poles will be cut to specified length. Fall off will not be saved or shipped.
note: twisted poles can appear uneven. Poles shown in 860 Grayed Brass.

custom solutions: french returns

Our custom metal shop can create custom bent and mitered pole returns for any window. For more details, see pages 50 – 53 in the Custom Solutions section.



accessories



A B C

- A SBTN**
steel baton, specify finish
3/8" Dia
specify length up to 60"
SBTN60
specify length up to 96"
- B FBTN**
fiberglass baton, white
3/8" Dia
specify length up to 48"
- C ABTN-36** NEW
clear acrylic baton
3/8" Dia, available in 36"
ABTN-48 NEW
clear acrylic baton
3/8" Dia, available in 48"



MB100
metal band, attaches any rosette to front
of 1" Dia pole
use with 1" pole only
for more information on metal bands,
see page 92 .



MB100 with EC3 rosette on
RR100 pole, finish 620
Weathered Iron



1 $\frac{1}{4}$ " steel

The 1 $\frac{1}{4}$ " steel collection features 30 finial designs in cast and forged styles for the perfect custom crafted detail. Classic shapes, architectural details and six new finial designs offer an updated appeal to this collection.



TFCS114111 **NEW**
1 3/4"L x 1 7/8"W, 1 5/8"Sq base
830 Driftwood
pictured with pole RD125



TFCS114120 **NEW**
1 7/8"L x 2 1/8"W, 1 3/4" base
880 Parchment
pictured with pole RD125



TFCS114190 **NEW**
1 7/8"L x 2 1/4"W, 1 5/8" base
870 Chalet Gray
pictured with pole RR125



TFCS114110 **NEW**
1 7/8"L x 1 3/8"W, 1 5/8" base
820 Sea Salt Black
pictured with pole RD125



TFCS114170 **NEW**
glass finial
2 7/8"L x 2 3/8"W, 1 5/8" base
810 Bronzed Ore
pictured with pole RD125



TFCS114171 **NEW**
glass finial
3 7/8"L x 2 1/8"W, 1 5/8" base
800 Charred Toasted Oak
pictured with pole RR125



RF4
1"L x 1 7/8"W
110 Flat Black with Gold
pictured with pole RR125



EC135 **OH**
1 1/4"L x 2 1/8"W, 2" base
110 Flat Black with Gold
pictured with pole RR125



SEC-125 **OH**
1/4"L x 1 1/3"W, 1 1/3" base
105 Bronze
pictured with pole RR125



SEC-2 **OH**
1/4"L x 2"W, 2" base
106 Bronze with Gold
pictured with pole SRT2

1 1/4"
steel



SF133
2"L x 2 3/8"W, 1 1/4" Sq base
770 Bronze Patina
pictured with pole RR125



SF230
2 1/4"L x 2"W, 1 7/8" base
610 Cobalt Bronze
pictured with pole RR125



SF237
2 1/8"L x 1 5/8"W, 1 7/8" base
330 Bronze with Black
pictured with pole RR125



SF-4
3 1/3"L x 2 1/2"W, 2" base
110 Flat Black with Gold
pictured with pole RR125



SF63 OH
2 1/2"L x 2 1/2"W, 2" base
129 Antique Steel
pictured with pole RR125



L9328
2"L x 2"W
106 Bronze with Gold
pictured with pole RR125



SF131
4"L x 2 1/4"W, 2" base
110 Flat Black with Gold
pictured with pole RR125



SSA
4"L x 3 1/8"W, 2" base
106 Bronze with Gold
pictured with pole SRT2



SF45
3"L x 2 1/2"W, 1 5/8" base
110 Flat Black with Gold
pictured with pole RR125

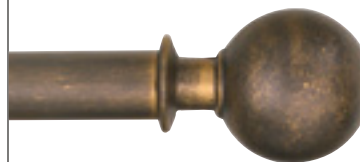

4519C OH
3 1/2"L x 2 3/4"W, 2" base
106 Bronze with Gold
pictured with pole RR125

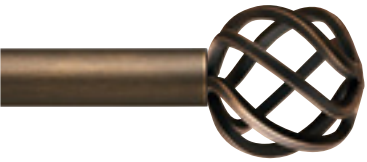

SF158B7
3"L x 2 3/4"W
106 Bronze with Gold
pictured with pole RR125



14R704
3 3/8"L x 2"W, 2" base
107 Bronze with Gold
and Gray
pictured with pole SRT2



K657
4"L x 2"W, 1 3/4" base
110 Flat Black with Gold
pictured with pole RR125



SF138
4"L x 2 1/4"W, 2" base
350G Statuary Bronze
with Gold
pictured with pole SRT2



SF132
4 1/4"L x 4 3/4"W, 2" base
350G Statuary Bronze with Gold
pictured with pole RR125



LS385 OH
5"L x 4 1/2"W
250B Platinum with
Black Highlights
pictured with pole SRT2

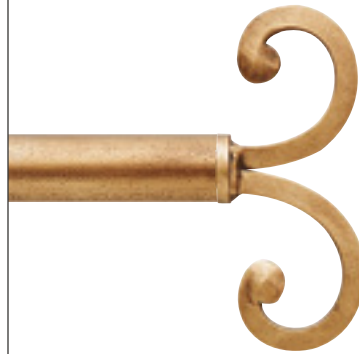

SF19
3 1/2"L x 6 3/4"W, 1 3/8" base
680 Aged Gold
pictured with pole RR125



SF70
5 1/4"L x 3"W, 2" base
270 Mahogany Rust
pictured with pole RR125



SF96
4 1/4"L x 7"W, 2" base
250 Platinum
pictured with pole SRT2

brackets

standard



BKT118-138
adjustable steel bracket, single
3 3/8" return, 1"W x 3 1/4"L
backplate



L125
steel bracket, single
2 1/2" return, 3/4"W x 2"L backplate



L235
steel bracket, single
3 1/2" return, 3/4"W x 3 3/8"L backplate



CSL125
steel bracket, single
2 3/8" return, 2 1/2"W x 1 1/2"L backplate

L135
steel bracket, single
3 3/8" return, 3/4"W x 2 1/2"L backplate

L26
steel bracket, single
6" return, 3/4"W x 3 3/8"L backplate

CSL135
steel bracket, single
3 3/8" return, 2 1/2"W x 1 1/2"L backplate

L16
steel bracket, single
6" return, 3/4"W x 2 1/2"L backplate

CSL16
steel bracket, single
6" return, 2 1/2"W x 1 1/2"L backplate



TFCS114GRSBK **NEW**
steel bypass bracket, single
3 1/2" return, 3/4"W x 3 3/4"L
backplate
Use with RR125 pole and
TFCS114MCRI c-ring.



TFCS114GRDBK **NEW**
steel bypass bracket, double
6" front and 3" back return,
3/4"W x 3 3/4"L backplate
Use with RR125 pole and
TFCS114MCRI c-ring.



EB3
steel eyelet bracket, single
3 1/2" return, 1"W x 3 1/2"H backplate
eyelet 1 3/8"ID



TFCS114MCMBK **NEW**
1 1/4" steel ceiling mount bracket
2" Dia ceiling plate, 2 3/4"H, 2 3/8"
drop (distance from ceiling to
bottom of pole)

EB4
steel eyelet bracket, single
6" return, 1"W x 3 1/2"H backplate
eyelet 1 3/8"ID

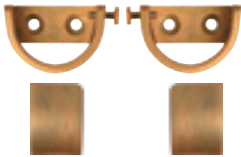

IM125
1 1/4" steel inside mount brackets
1 1/8"H x 1 3/8"W backplate, 3/4" Deep,
1/8" thick backplate per bracket
(sold in pairs)



TFCR114REL **NEW**
1 1/4" hinged elbow
3 3/8"L, (2 1/2"L each side when bent),
1 3/8" base

*Return distance is from wall to center of cradle.
Standard brackets shown in 680 Aged Gold.*

custom solutions: bypass brackets

CAUTION: Bypass Brackets do not have full cradles. Standard brackets must be installed at each end to secure 1 1/4" pole.



A

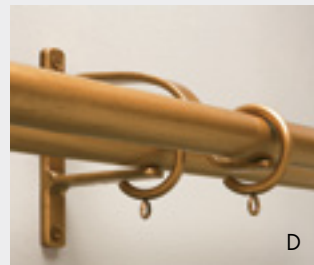

D

A. SCB35
steel custom bypass bracket, single
3 1/2" return, 3/4"W backplate
x 2 1/2" or 3"L

B. SCB6
steel custom bypass bracket, single
6" return, 3/4"W backplate
x 2 1/2" or 3"L

C. SCBC
steel custom bypass bracket, single
custom return, 3/4"W backplate
x 2 1/2" or 3"L

D. SCBCDBL
steel custom bypass bracket, double
custom return, 3/4"W backplate
x 5 1/4"L

Use with RD125 and RR125 poles and CR-SR7 c-ring. For more
bypass bracket information, see page 56.

custom solutions: brackets

The Finial Company is known for quality craftsmanship and can create custom brackets to match your job specifications. We can customize bracket dimensions, returns and finish on any pole for a custom fit on every job. For more custom solutions products see our custom brackets section on page 56.



TBKT
custom steel t-bracket, single
please specify:
A. return (distance from wall to center of cradle)
B. pole size and profile
note: 3 1/2"H backplate comes standard, unless otherwise specified



DBL1
custom steel bracket, double
please specify:
A. front pole size and profile
B. back pole size and profile
C. rings to be used, if any
D. front and back returns (distance from wall to center of cradle)
note: returns are contingent upon which poles and rings are chosen
3 1/2"H backplate comes standard, unless otherwise specified



BL4
custom steel ceiling mount bracket
please specify:
A. drop (distance from ceiling to top of pole)
B. pole size and profile
C. rings to be used, if any
note: minimum drop is contingent upon which finial and ring are chosen
2 1/2"W backplate comes standard, unless otherwise specified



FBKT
custom steel bracket, single
please specify:
A. return (distance from wall to center of cradle)
B. pole size and profile
note: 4 3/4"H backplate may not be modified

Return or drop distance in excess of 8" on any custom bracket will incur additional fees and requires addition of support arm. Custom brackets are shown unfinished, but will be hand painted in your selected Standard Finish (see back cover) or for a custom finish you can send us a finish sample and we'll prepare a strike-off sample for approval (see Retail Price List for custom finish charges).

rings



SR3
smooth steel ring
1 1/2"ID, 2"OD



FSR1
smooth heavy steel ring
1 3/4"ID, 2 3/4"OD



HSR1
hammered steel ring
1 3/4"ID, 2 1/2"OD



OVL3
smooth oval steel ring
1 1/2"ID, 2"OD, 2 1/2"L



CR-SR3
smooth steel c-ring
1 1/2"ID x 2"OD
use with RD125 pole and SCB35, SCB6, SCBC or SCBCDBL bypass brackets



CR-SR7
smooth steel c-ring
2 1/4"ID, 2 3/4"OD
use with RR125 pole and SCB35, SCB6, SCBC or SCBCDBL bypass brackets



TFCS114MCRI NEW
smooth steel c-ring
2"ID, 2 1/2"OD
use with RR125 pole and TFCS114GRSBK or TFCS114GRDBK bypass brackets



OVL1
hammered oval steel ring
1 3/4"ID, 2 1/2"OD, 3 1/4"L
Rings shown in 680 Aged Gold.

1 1/4"
steel

custom solutions: french returns

Our custom metal shop can create custom bent and mitered pole returns for any window. For more details, see pages 50–53 in the Custom Solutions section.



poles



RR125
1 1/4" round tube
maximum length is 192 inches

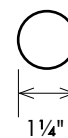

RD125
1 1/16" round tube, heavy walled
maximum length is 252 inches



SRT2
1 1/4" solid rope
maximum length is 228 inches use ring with minimum 1 3/4" ID

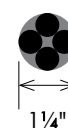

1 1/4" steel poles are sold in 1 foot increments, 2 foot minimum. Poles will be cut to specified length. Fall off will not be saved or shipped. **note:** twisted poles can appear uneven. Poles shown in 860 Grayed Brass.

accessories



A B C

- A SBTN**
steel baton, specify finish
3/8" Dia
specify length up to 60"
- SBTN60**
specify length up to 96"
- B FBTN**
fiberglass baton, white
3/8" Dia
specify length up to 48"
- C ABTN-36** **NEW**
clear acrylic baton
3/8" Dia, available in 36"
- ABTN-48** **NEW**
clear acrylic baton
3/8" Dia, available in 48"



1 $\frac{1}{2}$ " - 1 $\frac{3}{4}$ " steel

Our grandest in scale, the 1 $\frac{1}{2}$ " – 1 $\frac{3}{4}$ " steel collection is the perfect solution for windows that command a larger scale, luxurious window treatment. Two new classic finial designs have been added to this collection that provide the perfect proportion and style that will stand the test of time.

1 1/2" - 1 3/4"
steel



TFCS134190 **NEW**
2 1/4" L x 3" W, 2 1/4" base
880 Parchment
pictured with pole RD175



TFCS134100 **NEW**
4 3/8" L x 3 1/4" W, 2 1/4" base
860 Grayed Brass
pictured with pole RD175

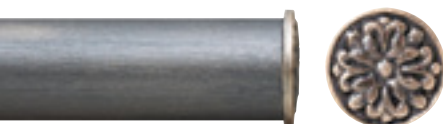

EC3
1/2" L x 2" W, 2" base
700 Graphite
pictured with pole RR175



SEC-2 **OH**
1/4" L x 2" W, 2" base
106 Bronze with Gold
pictured with pole TRT



FC1
1 1/3" L x 2 1/2" W, 2 3/8" base
110 Flat Black with Gold
pictured with pole RR175



SF192
4 3/8" L x 2 3/4" W, 2 1/8" base
760 Rustic Iron
pictured with pole RR175



SF138
4" L x 2 1/4" W, 2" base
350G Statuary Bronze
with Gold
pictured with pole TRT



SF-4
3 1/3" L x 2 1/2" W, 2" base
110 Flat Black with Gold
pictured with pole RR175



SF150
3 1/4" L x 2 1/2" W, 2 1/4" base
250B Platinum with
Black Highlights
pictured with pole TRT

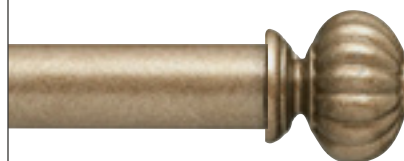

SF63 **OH**
2 1/2" L x 2 1/2" W, 2" base
129 Antique Steel
pictured with pole RR175

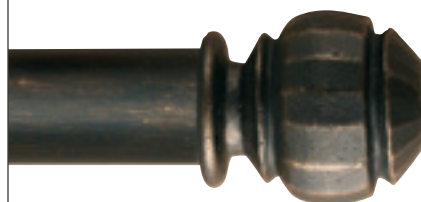

SF151 **OH**
3 1/2" L x 2 1/2" W, 2 1/8" base
110 Flat Black with Gold
pictured with pole RR175

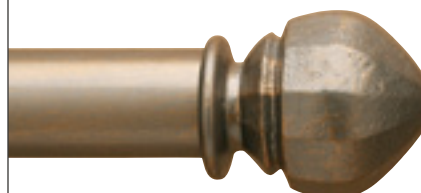

SF140
3 3/8" L x 2 3/4" W, 2 1/8" base
150 Gray with Gold
pictured with pole RR175



1340HB
3 3/4"L x 3 7/8"W, 1 3/8" base
110 Flat Black with Gold
pictured with pole RR175

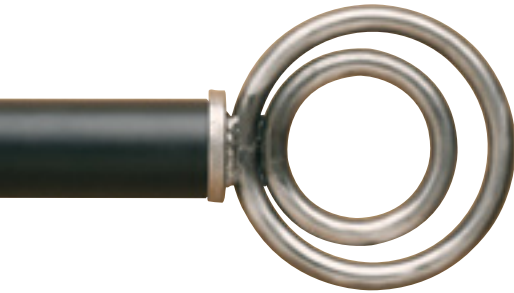

SF228
5 1/8"L x 4 7/8"W
100 Polished Steel*
pictured with pole RR175
109 Flat Black

**please note: there is an upcharge for this custom finish; please refer to Retail Price List for details.*



SF70
5 1/4"L x 3"W, 2" base
270 Mahogany Rust
pictured with pole RR175



L651FC1
6 3/8"L x 3 7/8"W, 2 3/8" base
110 Flat Black with Gold
pictured with pole RR175

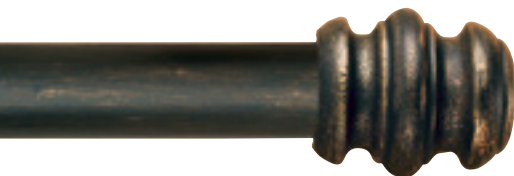

SF90
3 3/4"L x 3"W, 2 1/8" base
110 Flat Black with Gold
pictured with pole RR175



L848FC1 OH
8 3/4"L x 4 1/4"W, 2 3/8" base
110 Flat Black with Gold
pictured with pole RR175



LS385 OH
5"L x 4 1/2"W
250B Platinum with
Black Highlights
pictured with pole RR175



LS385FC1
6 1/4"L x 4 1/2"W, 2 3/8" base
250B Platinum with
Black Highlights
pictured with pole TRT



SF96
4 1/4"L x 7"W, 2" base
250 Platinum
pictured with pole TRT

1 1/2" - 1 3/4"
steel

brackets

standard



BKT112-134
adjustable steel bracket, single
3 7/8"-5 1/8" return, 1"W x 3 1/2"L
backplate



A17535
steel bracket, single
3 1/2" return, 3/4"W x 2 1/2"L backplate



B17535
steel bracket, single
3 1/2" return, 3/4"W x 3 2/3"L backplate



CS17535
steel bracket, single
3 1/2" return, 2 1/2"W x 1 1/2"L backplate

A1756
steel bracket, single
6" return, 3/4"W x 2 1/2"L backplate

B1756
steel bracket, single
6" return, 3/4"W x 3 2/3"L backplate

CS1756
steel bracket, single
6" return, 2 1/2"W x 1 1/2"L backplate



EB5
steel eyelet bracket, single
3 1/2" return, 1"W x 3 1/2"H backplate,
eyelet 1 7/8"ID

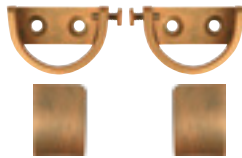

IM175
1 3/4" steel inside mount brackets
1 1/2"H x 2 3/8"W backplate, 3/4"Deep,
1/8" thick backplate per bracket
(sold in pairs)



SELB
1 3/4" hinged elbow
3"L, (2 1/3"L each side when bent),
1 3/4" base

EB6
steel eyelet bracket, single
6" return, 1"W x 3 1/2"H backplate,
eyelet 1 7/8"ID

Return distance is from wall to center of cradle. Standard brackets shown in 680 Aged Gold.

custom solutions: bypass brackets

CAUTION: Bypass Brackets do not have full cradles. Standard brackets must be installed at each end to secure 1 3/4" pole.



A

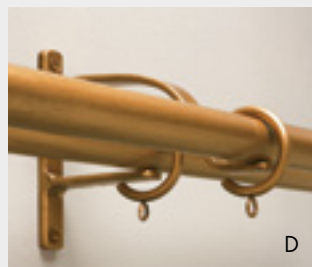

D

A. SCB35
steel custom bypass bracket, single
3 1/2" return, 3/4"W backplate x 2 1/2"
or 3"L

B. SCB6
steel custom bypass bracket, single
6" return, 3/4"W backplate x 2 1/2"
or 3"L

C. SCBC
steel custom bypass bracket, single
custom return, 3/4"W backplate
x 2 1/2" or 3"L

D. SCBCDBL
steel custom bypass bracket, double
custom return, 3/4"W backplate
x 5 1/4"L

Use with RD175 and RR175 poles and CR-SR12 c-ring. For more bypass bracket information, see page 56.

custom solutions: brackets

The Finial Company is known for quality craftsmanship and can create custom brackets to match your job specifications. We can customize bracket dimensions, returns and finish on any pole for a custom fit on every job. For more custom solutions products see our custom brackets section on page 56.



TBKT
custom steel t-bracket, single
please specify:
A. return (distance from wall to center of cradle)
B. pole size and profile
note: 3 1/2"H backplate comes standard, unless otherwise specified



DBL1
custom steel bracket, double
please specify:
A. front pole size and profile
B. back pole size and profile
C. rings to be used, if any
D. front and back returns (distance from wall to center of cradle)
note: returns are contingent upon which poles and rings are chosen
3 1/2"H backplate comes standard, unless otherwise specified



BL4
custom steel ceiling mount bracket
please specify:
A. drop (distance from ceiling to top of pole)
B. pole size and profile
C. rings to be used, if any
note: minimum drop is contingent upon which finial and ring are chosen
2 1/2"W backplate comes standard, unless otherwise specified



FBKT
custom steel bracket, single
please specify:
A. return (distance from wall to center of cradle)
B. pole size and profile
note: 4 3/4"H backplate may not be modified

Return or drop distance in excess of 8" on any custom bracket will incur additional fees and requires addition of support arm. Custom brackets are shown unfinished, but will be hand painted in your selected Standard Finish (see back cover) or for a custom finish you can send us a finish sample and we'll prepare a strike-off sample for approval (see Retail Price List for custom finish charges).

rings



SR7
smooth steel ring
2 1/4"ID, 2 3/4"OD



FSR2
smooth heavy steel ring
2"ID, 3"OD



HSR175
hammered steel ring
2"ID, 2 3/4"OD



SR5
twisted steel ring
2 5/8"ID, 3"OD



OVL7
smooth oval steel ring
2 1/4"ID, 2 3/4"OD, 3 1/2"L



OVL175
hammered oval steel ring
2"ID, 2 3/4"OD, 3 1/2"L



CR-SR12
smooth steel c-ring
2 5/8"ID, 3"OD use with RR175 or RD175 pole and SCB35, SCB6, SCBC or SCBCDBL bypass brackets

Rings shown in 680 Aged Gold.

1 1/2" - 1 3/4"
steel

custom solutions: french returns

Our custom metal shop can create custom bent and mitered pole returns for any window. For more details, see pages 50–53 in the Custom Solutions tab.



poles



RR175
1 3/4" Dia round tube
maximum length is 192 inches

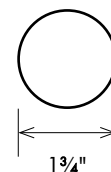

RD175
1 5/8" Dia round tube, heavy walled
maximum length is 288 inches

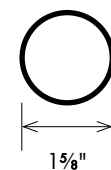

TRT
1 1/2" Dia twisted tube
maximum length is 216 inches use ring with
minimum 2" ID

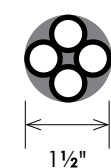

1 1/2"-1 3/4" steel poles are sold in 1 foot increments, 2 foot minimum. Poles will be cut to specified length. Fall off will not be saved or shipped. **note:** twisted poles can appear uneven. Poles shown in 860 Grayed Brass.

accessories



- A SBTN**
steel baton, specify finish
3/8" Dia
specify length up to 60"
- SBTN60**
specify length up to 96"
- B FBTN**
fiberglass baton, white
3/8" Dia
specify length up to 48"
- C ABTN-36** NEW
clear acrylic baton
3/8" Dia, available in 36"
- ABTN-48** NEW
clear acrylic baton
3/8" Dia, available in 48"



outdoor hardware

With the growing popularity of indoor and outdoor spaces blending together, our outdoor hardware collection was designed to make sure those spaces are covered with style and functionality. We've curated an assortment of finials and accessories from our popular steel collection and created five weather resistant finishes that have been certified for outdoor use. Our 5 year warranty guarantees against rust and fading due to conditions such as UV exposure, humidity and sea spray.



outdoor living made easy

5 custom finishes

available on all Outdoor Hardware products with protective high gloss, weather-resistant topcoat

5 year warranty

against rust and fading when properly maintained. Tested for outdoor use and guaranteed against:

- UV Exposure
- Humidity
- Sea Spray



Each order will include 2 oz. of finish and protective topcoat for periodic maintenance.



450-OH
Aluminum Gloss



440-OH
Soft Gold Gloss



103-OH
Satin Black Gloss



105-OH
Bronze Gloss



270-OH
Mahogany Rust Gloss

Outdoor Hardware Limited Warranty

All Outdoor Hardware is guaranteed to be free of manufacturing defects and is covered under our Manufacturers Limited Warranty. The product is guaranteed not to rust and the finish not to fade for 5 years if the product is maintained according to the "Product Care" information. In the event of rusting or fading, photography may be requested for finalization of claims on a case-by-case basis.

Outdoor Hardware Product Care

Unlike indoor drapery hardware, outdoor hardware requires periodic maintenance. It is important that any damages or finish abrasion be repaired immediately. Any scratches incurred during installation must be repaired at that time. Stainless steel mounting hardware is recommended, but not included. Each order will include 2 oz. of finish and protective topcoat for periodic maintenance.

In addition, twice a year, it is important to clean and inspect the outdoor hardware for scratches or wear patterns that could expose the metal and result in rusting. This is very important for treatments with rings. If such areas are discovered, apply the paint finish sent with the order. When dry, apply the clear protective topcoat also provided.

please note: allow 10-15 business days for production of **Outdoor Hardware Collection**. Professional installation recommended due to weight of steel products. Brackets recommended every 3 feet. Splicing not recommended for steel rods.



L848-OH
7½"L x 4¼"W, 1" base
103-OH Satin Black Gloss
pictured with pole 75HSRB
for ¾" and 1" poles



SEC125-OH
¼"L x 1⅓"W, 1⅓" base
450-OH Aluminium Gloss
pictured with pole ST2
for ¾", 1" and 1¼" poles



EC135-OH
1¼"L x 2⅞"W, 2" base
103-OH Satin Black Gloss
pictured with pole RR125
for 1" and 1¼" poles



4519C-OH
3½"L x 2¾"W, 1¾" base
440-OH Soft Gold Gloss
pictured with pole RR100
for 1" and 1¼" poles

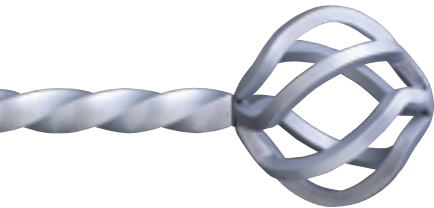

LS385-OH
5"L x 4½"W
450-OH Aluminium Gloss
pictured with pole ST3
for 1¼" and 1¾" poles



SF63-OH
2½"L x 2½"W, 2" base
105-OH Bronze Gloss
pictured with pole RR125
for 1¼" and 1¾" pole



SEC2-OH
¼"L x 2"W, 2" base
270-OH Mahogany Rust Gloss
pictured with pole RR175
for 1¼" and 1¾" poles



L848FC1-OH
8¾"L x 4¼"W, 2⅞" base
103-OH Satin Black Gloss
pictured with pole RR175
for 1¾" pole



SF151-OH
3½"L x 2½"W, 2⅞" base
103-OH Satin Black Gloss
pictured with pole RR175
for 1¾" pole

outdoor rosettes



R16-OH
3"Dia
450-OH Aluminium Gloss



R101-OH
5½"Dia
270-OH Mahogany Rust Gloss with
440-OH Soft Gold Gloss on petals*



steel tieback post for rosettes
bottom base 1¾"Dia
NBL2-OH 2½" projection
NBL4-OH 3½" projection
NBL6-OH 6" projection

*please note: there is a custom upcharge for this special finish treatment

brackets



steel bracket, single
L235-OH 3½" return, for ¾", 1" and 1¼" pole
L26-OH 6" return, for ¾", 1" and 1¼" pole
B17535-OH 3½" return, for 1¾" pole
B1756-OH 6" return, for 1¾" pole



steel eyelet bracket, single
EB3-OH 3½" return for 1" and 1¼" pole
EB4-OH 6" return, for 1" and 1¼" pole
EB5-OH 3½" return, for 1¾" pole
EB6-OH 6" return, for 1¾" pole



steel inside mount bracket
IM125-OH 1½"H x 1⅓"W backplate, ¾"Deep, for 1", 1¼" pole, pair
IM175-OH 1½"H x 2⅜"W backplate, ¾"Deep for 1¾" pole, pair

Return distance is from wall to center of cradle. Brackets shown in 103-OH Satin Black Gloss.

rings



smooth steel ring
 for ¾" pole:
SR1-OH 1"ID, 1½"OD
 for 1" or 1¼" pole:
SR3-OH 1½"ID, 2"OD
 for 1¾" pole:
SR7-OH 2¼"ID, 2¾"OD



hammered steel ring
 for 1" or 1¼" pole:
HSR1-OH 1¾"ID, 2½"OD
 for 1¾" pole:
HSR175-OH 2"ID, 2¾"OD



twisted steel ring
 for 1", 1¼" or 1¾" pole:
SR5-OH 2⅝"ID, 3"OD



hammered oval steel ring
 for 1" or 1¼" pole:
OVL1-OH 1¾"ID, 2½"OD
 for 1¾" pole:
OVL175-OH 2"ID, 2¾"OD

Please note: rings may abrade protective outdoor finish with frequent use. Please see Product Care for maintenance recommendations. All rings shown in 103-OH Satin Black Gloss.

poles



75HSRB-OH
 ¾"Dia hammered solid steel pole, round
 maximum length is 115 inches

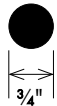

ST2-OH
 1" single twist solid steel pole
 maximum length is 228 inches; use ring with minimum 1½"ID

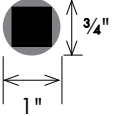

ST3-OH
 1" double twist solid pole
 maximum length is 228 inches; use ring with minimum 1½"ID

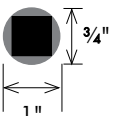

RR100-OH 1"Dia round tube
RR125-OH 1¼"Dia round tube
RR175-OH 1¾"Dia round tube
 maximum length is 192 inches

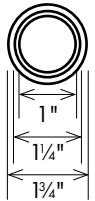

Steel poles are sold in 1 foot increments, 2 foot minimum. Poles will be cut to specified length. Fall off will not be saved or shipped. Poles shown in 103-OH Satin Black Gloss.

tiebacks



TTBH1-OH
 4½"L x 1¼" projection
 103-OH Satin Black Gloss



TTBH2-OH
 3½"L x 1¼" projection
 103-OH Satin Black Gloss



custom solutions

custom pole returns	50
custom brackets	56
custom accessories	57
custom arches	59
custom finishes	60





custom solutions

The Finial Company is known for flexibility, and custom solutions are our specialty. Whether you need a custom bent or mitered return, unique bracket style, specialty window solution or a custom finish match, we can create one of a kind drapery hardware to complement your window design.



Steel Pole 90° Bent Returns

Round backplates: 1 3/8" Dia (for 1/2" 50SRB), 2" Dia (for 3/4" 75HSRB, 3/4" 75RD, 1 1/16" RD125 and 1 5/8" RD175). Rectangular backplates upon request.
Rectangular backplates: 3"L x 1 1/2"W (for 1" 1SQ). Round backplates upon request.

Sold in one foot increments, 2 foot minimum charge.

Pictured: 3/4" 75RD with 90° bent returns with CR-SR75 steel c-rings; finish 150 Gray with Gold.

poles



50SRB

1/2" Dia steel, round solid pole
maximum length is 240". Not available for use with
bypass brackets and c-rings.

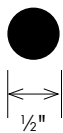

RD125 NEW
1 1/16" Dia round tube, heavy walled
maximum length is 252".

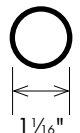

75HSRB

3/4" Dia hammered solid steel pole, round
maximum length is 115". Not available for use with
bypass brackets and c-rings.

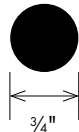

RD175 NEW
1 5/8" Dia round tube, heavy walled
maximum length is 192".

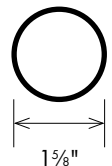

75RD

3/4" Dia solid steel pole, round
maximum length is 220.

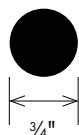

1SQ NEW

1" Dia smooth square tube
maximum length is 288"; use with L125-SQ, L135-SQ
brackets, SQRG1 ring. Not available for use with bypass
brackets and c-rings.

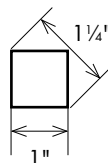

NOTE:

- Double pole treatments are also available with bent returns on the front pole.
- Available in all 50 hand-painted finishes and any custom finish.
- Pole length and return must be specified; please refer to the Retail Price List for required measurements.
- Poles shown in 860 Grayed Brass.

brackets

custom pole returns



BKT050-1
adjustable steel bracket, single
2½"-3⅓" return
½" use with 50SRB pole

BKT075-100
adjustable steel bracket, single 3½"-5" return
¾" & 1" use with 75HSRB, 75RD, RR100, SRT1, ST2 or ST3 pole

BKT118-138
adjustable steel bracket, single 3⅝"-4⅞" return
1¼" use with RR125, RD125 or SRT2 pole

BKT112-134
adjustable steel bracket, single 3⅞"-5⅛" return
1¾" use with RR175, RD175 or TRT pole



L135100
steel bracket, single
3⅞" return
¾", 1" use with 75HSRB, 75RD, RR100, SRT1, ST2 or ST3 pole

L135
steel bracket, single
3⅞" return
1¼" use with RR125, RD125 or SRT2 pole

A17535
steel bracket, single
3½" return
1¾" use with RR175, RD175 or TRT pole



BKT050-3
steel extension bracket, single
6" return
½" use with 50SRB pole

L16
steel extension bracket, single
6" return
1¼" use with RR100, RR125, RD125 or SRT2 pole

A1756
steel extension bracket, single
6" return
1¾" use with RR175, RD175 or TRT pole



L135-SQ
square bracket, single
3½" return
¾", 1" use with SRH75, 1SQ or SHT1 pole



TFCS114GRSBK **NEW**
steel bypass bracket, single
3½" return
1", 1¼" use with RR100 or RR125 pole



TFCS114GRDBK **NEW**
steel bypass bracket, double
3" back and 6" front return
1", 1¼" use with RR100 or RR125 pole

rings



SR05
smooth steel ring
¾"ID, 1⅛"OD
½" use with 50SRB

SR1
smooth steel ring
1"ID, 1½"OD
¾" use with 75HSRB, 75RD

SR3
smooth steel ring
1½"ID, 2"OD
1", 1¼" use with RR100, SRT1, ST2, ST3, RR125, RD125 or SRT2 pole

SR7
smooth steel ring
2¼"ID, 2¾"OD
1¾" use with RR175, RD175 or TRT pole



FSR1
smooth heavy steel ring
1¾"ID, 2¾"OD
1", 1¼" use with RR100, SRT1, ST2, ST3, RR125, RD125 or SRT2 pole

FSR2
smooth heavy steel ring
2"ID, 3"OD
1¾" use with RR175, RD175 or TRT pole



SQRG1
smooth square steel ring
1⅝"ID, 2⅛"OD
¾" or 1" use with 1SQ, SRH75 or SHT1 pole



TFCS100SCRI **NEW**
smooth steel c-ring
1½"ID, 2"OD
1", 1¼" use with RR100 pole and TFCS100GRSBK or TFCS100GRDBK bypass brackets



TFCS114MCRI **NEW**
smooth steel c-ring
2"ID, 2⅝"OD
1", 1¼" use with RR125 pole and TFCS114GRSBK or TFCS114BGRDBK bypass brackets

Brackets and rings shown coordinate with custom bent and mitered steel poles. Additional brackets and rings are available. Rings and brackets shown in 680 Aged Gold.



Steel Pole 90° Mitered Returns

Round Backplates: 1 3/8" Dia (for 1/2" pole), 2" Dia (for 3/4", 1" and 1 1/4" poles) and 3" Dia (for 1 3/4" pole).

Rectangular Backplates: 3"L x 1 1/2"W (for 1/2" 50SRB, 3/4" 75HSRB and 75RD, 1" 1SQ, RR100, ST2, ST3, SRT1, SHT1, 1 1/4" RR125, RD125, SRT2, and RR125) and 3 1/2"L x 2"W (for RR175 and TRT). Round backplates upon request.

Sold in one foot increments, 2 foot minimum charge. Ring inner diameter must clear the mitered pole corner, if used.

Pictured: 1" RR100 with 90° Mitered Returns with SR3 steel rings, finish 250 Platinum.

poles



50SRB

1/2" Dia steel, round solid pole
maximum length is 240". Not available for use with
bypass brackets and c-rings.



75RD

3/4" Dia solid steel pole, round
maximum length is 220"



SRH75

3/4" Dia hammered solid steel pole, square
maximum length is 228". Not available for use with
bypass brackets and c-rings.

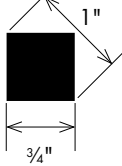

75HSRB

3/4" Dia hammered solid steel pole, round
maximum length is 115". Not available for use with
bypass brackets and c-rings.



ST2

1" Dia single twist solid steel pole
maximum length is 228"; use ring with minimum 1 1/2" ID.
Not available for use with bypass brackets and c-rings.

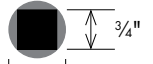

ST3

1" Dia double twist solid pole
maximum length is 228"; use ring with minimum 1 1/2" ID.
Not available for use with bypass brackets and c-rings.

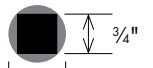

SRT1

1" Dia solid rope twist pole
maximum length is 228"; use ring with minimum 1 1/2" ID.
Not available for use with bypass brackets and c-rings.



RR100

1" Dia round tube
maximum length is 192"





1SQ
1" Dia smooth square tube
maximum length is 288"; use with L125-SQ, L135-SQ brackets, SQRG1 ring. Not available for use with bypass brackets and c-rings.

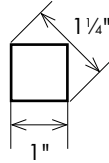

SHT1
1" Dia square hammered tube
maximum length is 228"; use with L125-SQ, L135-SQ brackets, SQRG1 ring. Not available for use with bypass brackets and c-rings.

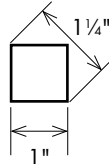

RD125
1 1/8" Dia round tube, heavy walled
maximum length is 252"

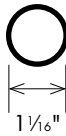

SRT2
1 1/4" Dia solid rope
maximum length is 228"; use ring with minimum 1 3/4" ID. Not available for use with bypass brackets and c-rings.

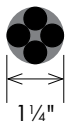

RR125
1 1/4" Dia round tube
maximum length is 192"

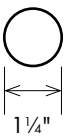

TRT
1 1/2" Dia twisted tube
maximum length is 216"; use ring with minimum 2" ID. Not available for use with bypass brackets and c-rings.

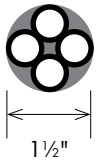

RD175
1 3/8" Dia round tube, heavy walled
maximum length is 288"

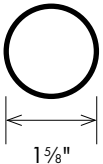

RR175
1 3/4" Dia round tube
maximum length is 192"

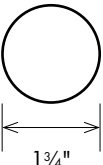

NOTE:

- Double pole treatments are also available with mitered returns on the front pole.
- Available in all 50 hand-painted finishes and any custom finish.
- Pole length and return must be specified; please refer to the Retail Price List for required measurements.
- Twisted poles can appear uneven.

custom solutions: bypass brackets and c-rings

CAUTION: Bypass Brackets do not have full cradles. Standard brackets must be installed at each end to secure pole.

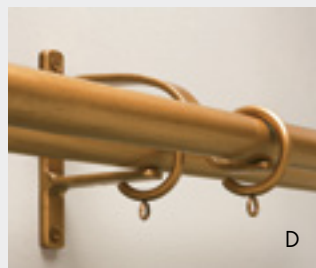
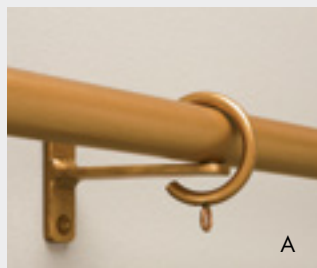

A. SCB35

steel custom bypass bracket, single 3 1/2" return, 3/4"W backplate x 2 1/2" or 3"H

B. SCB6

steel custom bypass bracket, single 6" return, 3/4"W backplate x 2 1/2" or 3"H

C. SCBC

steel custom bypass bracket, single custom return, 3/4"W backplate x 2 1/2" or 3"H

D. SCBCDBL

steel custom bypass bracket, double custom return, 3/4"W backplate x 5 1/4"H

Use all bypass brackets with 75RD, RR100, RR125, RD125, RR175 and RD175 poles.

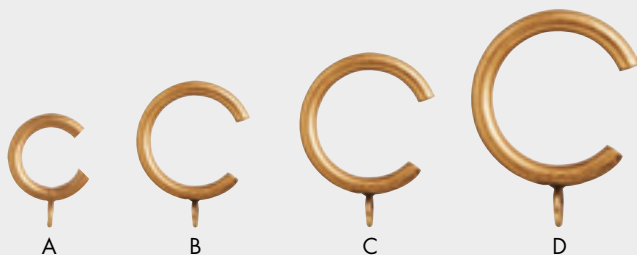

A. CR-SR75

smooth steel c-ring
1 1/4" ID, 1 3/4" OD
3/4" use with 75RD

B. CR-SR3

smooth steel c-ring
1 1/2" ID, 2" OD
1", 1 1/4" use with RR100 or RD125 pole

C. CR-SR7

smooth steel c-ring
2 1/4" ID, 2 3/4" OD
1 1/4" use with RR125

D. CR-SR12

smooth steel c-ring
2 5/8" ID, 3" OD
1 3/4" use with RR175 or RD175 pole



wood pole mitered returns

- We can custom miter wood poles and traverse fascia to cover any corner or bay window.
- Mitered returns create a finished look on wood fascia and allow you to seamlessly cover a specialty window with angles.
- Single and double pole treatments are available with mitered returns.
- Mitered return fees are charged per corner. Please reference the Retail Price List for a list of required measurements and surcharges.

Wood poles sold in 2 foot increments, 2 foot minimum charge.

Ring inner diameter must clear the mitered pole corner, if used. See reference chart in Retail Price List.

miters for wood poles and wood fascias are great for situations like these...

- We can miter our wood poles at any angle for you.



Shown: 90° inside corner miter for 225WG wood pole, WL1 steel brackets, finish 710 Tarnished Silver



90° inside corner



Shown: 90° outside corner miter for 225WS wood pole, WL1 steel brackets, finish 710 Tarnished Silver



90° outside corner

- We cannot miter traverse system tracks, but the traverse wood fascia can connect and miter at the corner.



Shown: 120° mitered bay corner for light duty corded traverse system, 225FL wood fascia, finish 740 Smoky Mocha; bronze track, bracket, and components



mitered bay corner
(angle varies)

custom brackets

The Finial Company is known for quality craftsmanship and can create custom brackets to match your job specifications. We can customize bracket dimensions, returns and finish on any pole for a custom fit on every job.



TBKT
custom steel t-bracket, single

please specify:

- A. return (distance from wall to center of cradle)
- B. pole size and profile

note: 3½"H backplate comes standard, unless otherwise specified



DBL1
custom steel bracket, double

please specify:

- A. front pole size and profile
- B. back pole size and profile
- C. rings to be used, if any
- D. front and back returns (distance from wall to center of cradle)

note: returns are contingent upon which poles and rings are chosen

3½"H backplate comes standard, unless otherwise specified



BL4
custom steel ceiling mount bracket

please specify:

- A. drop (distance from ceiling to top of pole)
- B. pole size and profile
- C. rings to be used, if any

note: minimum drop is contingent upon which finial and ring are chosen

2½"W ceiling plate comes standard, unless otherwise specified



FBKT
custom steel bracket, single

please specify:

- A. return (distance from wall to center of cradle)
- B. pole size and profile

note: 4¾"H backplate may not be modified

Return or drop distance in excess of 8" on any custom bracket will incur additional fees and requires addition of support arm. Custom brackets are shown unfinished, but will be hand painted in your selected Standard Finish (see back cover) or for a custom finish you can send us a finish sample and we'll prepare a strike-off sample for approval (see Retail Price List for custom finish charges).

custom bypass brackets

Our bypass brackets and c-rings allow continuous ring movement along the length of your pole. These work particularly well for long one-way draw treatments, unusually wide windows, and walls featuring multiple windows.

CAUTION: Bypass Brackets do not have full cradles. Standard brackets must be installed at each end to secure pole.

SCB35
steel bypass bracket, single
standard 3½" return, ¾"W backplate x 2½" or 3"L

SCB6
steel bypass bracket, single
6" return, ¾"W backplate x 2½" or 3"L

SCBC
steel custom bypass bracket, single
custom return, ¾"W backplate x 2½" or 3"L

please specify:

- A. 75RD (¾") RR100 (1"), RR125 (1¼"), RD125 (1¼"), RR175 (1¾") pole, or RD175 (1¾") pole

- B. return (distance from wall to center of cradle)

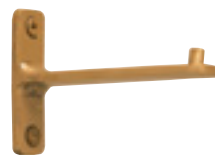

SCB35



SCBCDBL
steel custom bypass bracket, double
custom front and back return, ¾"W backplate x 5¼"L

please specify:

- A. 75RD (¾") RR100 (1"), RR125 (1¼"), RD125 (1¼"), RR175 (1¾") pole, or RD175 (1¾") pole

- B. front and back returns (distance from wall to center of cradle)

note: return may be restricted by the size of poles and rings specified

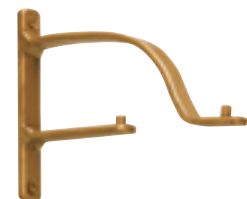

SCBCDBL

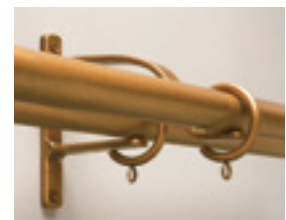

Return or drop distance in excess of 8" on any custom bracket will incur additional fees and requires addition of support arm.

custom accessories

custom accessories

Want to further customize your steel products? We can add a variety of decorative items to our steel products for you. *Additional charges apply.*



SL
short leaf
6"L x 1¾"W

This leaf can be welded to the front of any steel bracket with a maximum return of 3½".

When ordering your bracket, please specify addition of SL.



LL
long leaf
11½"L x 1¾"W

This leaf can be welded to the front of any steel bracket with a maximum return of 8".

When ordering your bracket, please specify addition of LL.



SL3
steel leaf
2¼"L x 1¾"W

SL3 welded to SR3 ring

This leaf can be welded to any steel ring or steel bracket.

When ordering your ring or bracket, please specify addition of SL3, and in what position it should be attached.

SL3 welded to SR3 ring

Add any rosette medallion or end cap to the front of any standard or custom steel bracket.

When ordering your bracket, please specify addition of rosette medallion and the following:

1. which rosette medallion or end cap to be added
2. attachment method:
 - a. machine screw (medallion may easily be changed later)
 - b. weld (permanent attachment; only available for steel rosettes or steel end caps)

please note: rosette medallions and brackets sold separately additional charges apply

For additional information on how to order custom brackets, please refer to the Retail Price List.



EC3 welded to front of bracket L135, RR100 pole, SR3 rings, finish 620 Weathered Iron. See pages 89-91 for Rosette options.

swing arms

Swing Arms can be a nice solution for window treatments in front of doors, shutters, and other unique areas where the drapery panel needs to conveniently swing out of the way.



L9328 finial, 350G Statuary Bronze with Gold Shown with scroll.

large swing arm with scroll
maximum length 36"
1"Dia pole RD125
8½"H x 1¼"W backplate
L9328 finial included: 1¾"Dia
350G Statuary Bronze with Gold

please note: Other finials may be substituted. Replacement finial sold separately.



K659 finial, 350G Statuary Bronze with Gold Shown without scroll.

large swing arm without scroll
maximum length 36"
1"Dia pole RD125
8½"H x 1¼"W backplate
L9328 finial included: 1¾"Dia
350G Statuary Bronze with Gold

please note: Other finials may be substituted. Replacement finial sold separately.



EC4 finial, 350G Statuary Bronze with Gold

small swing arm
maximum length 20"
½"Dia pole 50SRB
4"H x ¾"W backplate
EC4 finial included: ¾"L x 1½"W
350G Statuary Bronze with Gold

please note: Other finials may be substituted. Replacement finial sold separately.

For additional information on how to order, please refer to the Retail Price List.

finial adaptors





If the finial you want isn't shown in the diameter you need, order a finial adaptor for a nominal fee. The finial adaptor acts as the new finial base.

Finials are located in certain diameter categories based on the following criteria:

- the finial base fits the pole without additional modification
- finial shape and size is in proportion to the pole diameter

Finial Adaptor Tips:

- It is typically easier and more visually pleasing to adapt a finial to a larger diameter pole, rather than a smaller diameter pole.
- Many finials are located in multiple size categories because they look appropriate for several pole sizes; you may not need an adaptor.

base adaptor size	use for pole diameters
 FA-S: 1 3/8" Dia	1/2", 3/4", 1", 1 1/4"
 FA-M: 2" Dia	1 1/2" - 1 3/4"
 FA-L: 3" Dia	2" - 2 1/4"
 FC1: 2 3/8" Dia	1 1/2" - 1 3/4", 2" - 2 1/4"



L9328B finial with RR100 pole

custom tiebacks



TBA
 6"L back arm x 4 1/2"L front arm,
 4 1/2" projection
 100 Polished Steel*
 attach finial or rosette of choice to face or tip of TBA.
 pictured with L651 finial
 finial sold separately



STBA1
 8"L back arm x 8"L front arm,
 6 1/2" projection
 610 Cobalt Bronze
 attach finial or rosette of choice
 pictured with R73 rosette
 rosette sold separately

**please note: there is an upcharge for this custom finish; please refer to Retail Price List for details.*

arched window solutions

- Available for 1/2" 50SRB, 3/4" 75RD and 75HSRB, 1" SRT1, 1 1/4" RD125, and SRT2 poles only.
- Some poles will need to be cut at apex (center) for shipping; some arches cannot be achieved.
- Arched poles with splices are subject to additional bending fees.

IMPORTANT: A template is required to ensure accuracy of production. For information on how to create your template, please refer to the Retail Price List.

standard arch

arch height is equal or greater than half the arch width

eyebrow arch

arch height is less than half the arch width



shown: SR3 rings welded onto 1 1/4" RR125 pole
ARBE and L135 brackets
finish 810 Bronzed Ore

ARBC arched rod center bracket

Please specify return (distance from wall to center of cradle)

note: cannot be used for installations with rings (brackets without eyelet cradles may be substituted)



ARBE arched rod end brackets

Sold in pairs only
Please specify return (distance from wall to center of cradle) and pole being used.
Cups are custom made to style of pole.

note: outer ring can only reach 1 1/2" from end of pole due to the bracket cup



do you need a vertical or horizontal arch?

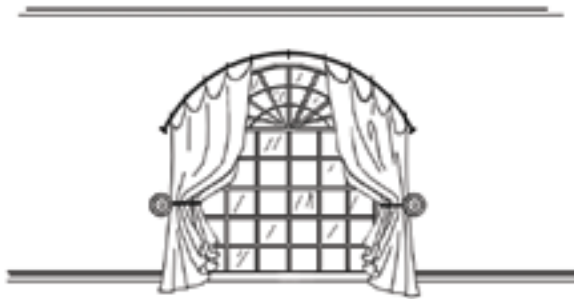

Vertical Arch Installation
great for arched windows

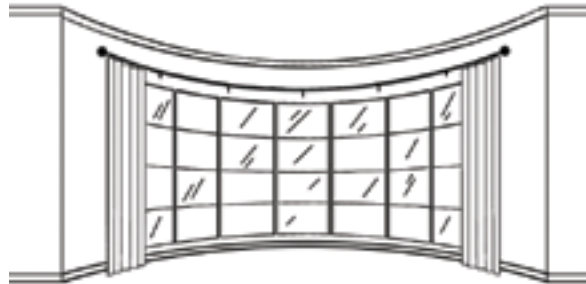

Horizontal Arch Installation
great for curved bay windows

please note: If using rings for vertical arch installation, rings must be welded into place. Ring position must be noted on your template. Outermost rings must be a minimum of 1 1/2" from end of pole due to ARBE bracket cup. Rings sold separately.

Any steel bracket or finial may be used for this type of arch.

custom finishes

Beyond our standard finishes, our artisans can match any finish, fabric swatch, wood trim or paint color specified from your favorite paint supplier allowing you to create complementary custom finishes in subtle or bold and vivid color palettes. The Finial Company can provide a strike-off sample on any wood or steel pole profile, upon request. Please reference the Retail Price List for required specifications and surcharges.



polished steel finish

Many, but not all, of our raw steel products can be polished and given a clear topcoat to achieve a finished look. Steel is not uniform in color tone and will vary in shades of gray and silver. Polishing raw steel parts requires considerably more preparation work than our other finishes and therefore incurs additional charges. Steel items that cannot be polished are listed in The Finial Company Retail Price List.

adding clear topcoat

For an additional charge, we can add a clear topcoat to any finish to achieve your preferred sheen level.



matte



satin



high gloss

painting fees

We will repaint hardware from The Finial Company or another manufacturer at the customer's request. We will also paint unfinished hardware from any manufacturer.

touch-up paint

Touch-up paint can be sent to the customer on request, for an additional charge.



Please refer to the Retail Price List for more details and a list of applicable charges.



wood & resin

1 ³ / ₈ " collection	61
2"- 2 ¹ / ₄ " collection	68
3" collection	81
rosettes	88
tiebacks	93
crests	94

1³/₈"
2"-2¹/₄"
3"

1 3/8"

actual pole sizes

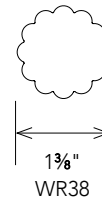
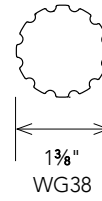
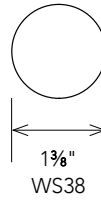
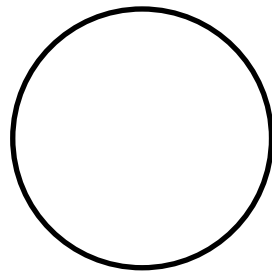

2"-2 1/4"

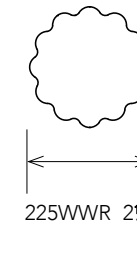
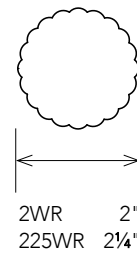
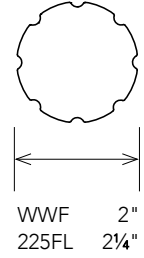
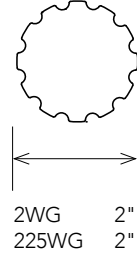
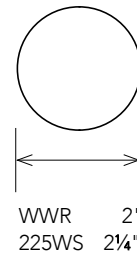
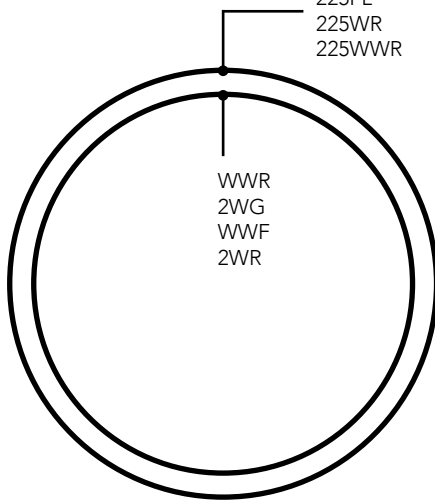

3"

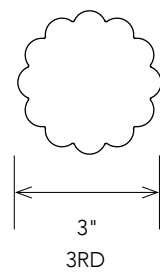
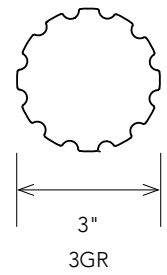
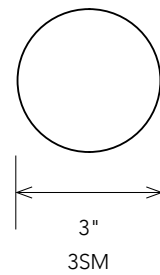
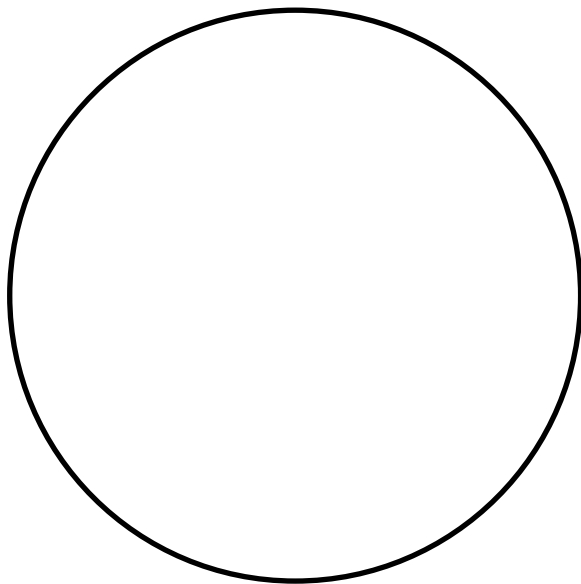



1³/₈" wood & resin

In our wood & resin collections, The Finial Company offers the timeless classics that never go out of style and the transitional new favorites that accentuate today's modern aesthetic. The 1³/₈" wood & resin collection features over 10 new finial designs with sleek profiles and exceptional design details available in our 50 hand painted standard finish options.

1 3/8" wood & resin



TFCR138190 **NEW**
1"L x 1 7/8"W, 1 7/8" base
810 Bronzed Ore
pictured with pole
WS38



TFCR138191 **NEW**
1 1/4"L x 2 1/4"W, 2" base
840 White with Gold
Accents
pictured with pole WG38



TFCR138192 **NEW**
2 1/4"L x 2 1/4"W, 1" base
610 Cobalt Bronze
pictured with pole WS38



RF5
1"L x 1 3/4"W, 1 3/8" base
107 Bronze with Gold
and Gray
pictured with pole WG38



F138-9
5/8"L x 2 1/8"W, 1 7/8" base
640 Oil Rubbed Bronze
pictured with pole WS38



TFCR138121 **NEW**
2 7/8"L x 2 7/8"W, 2" base
810 Bronzed Ore
pictured with pole WS38



TFCR138130 **NEW**
3 1/2"L x 4 3/8"W, 2" base
710 Tarnished Silver
pictured with pole
WNF38



TFCR138125 **NEW**
3 7/8"L x 2 1/2"W, 1 7/8" base
800 Charred Toasted Oak
pictured with pole WNF38

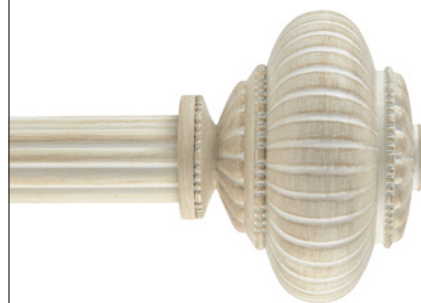

TFCR138131 **NEW**
3 7/8"L x 4 5/8"W, 2" base
880 Parchment
pictured with pole WR38



TFCR138170 **NEW**
glass finial
3 3/8"L x 3 1/4"W, 1 7/8" base
110 Flat Black with Gold
pictured with pole WNF38



TFCR138171 **NEW**
glass finial
3 3/8"L x 3 1/4"W, 2 1/8" base
840 White with Gold
Accents
pictured with pole WS38



TFCR138124 **NEW**
3 7/8"L x 3 1/4"W, 2" base
790 Vintage Bronze
pictured with pole WS38



F138-3
4"L x 3"W, 1 7/8" base
660 Antique White
pictured with pole WNF38



TFCR138172 **NEW**
glass finial
4 1/2"L x 4 3/4"W, 2" base
112 Silver with Gold
pictured with pole WR38



TFCR138126 **NEW**
3 7/8"L x 3 1/4"W, 2" base
810 Bronzed Ore
pictured with pole WS38



TFCR138165 **NEW**
5 3/4"L x 3 1/8"W, 2" base
870 Chalet Gray
pictured with pole WNF38



TFCR138110 **NEW**
3 1/2"L x 3 3/8"W, 1 7/8" base
107 Bronze with Gold
and Gray
pictured with pole WNF38



TFCR138164 **NEW**
4 3/8"L x 3 1/8"W, 4 3/8" base
690 Champagne
pictured with pole WS38

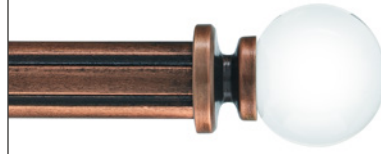

F138-5C
crystal finial
3 1/4"L x 2 1/2"W, 1 7/8" base
730 Rose Gold
pictured with pole WNF38

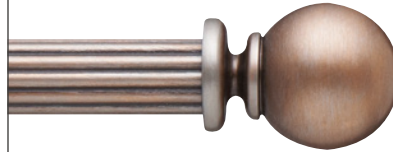

F138-5S
3 1/4"L x 2 1/2"W, 1 7/8" base
760 Rustic Iron
pictured with pole WR38



F138-8
3 1/4"L x 3"W, 1 7/8" base
650 Hickory
pictured with pole WS38

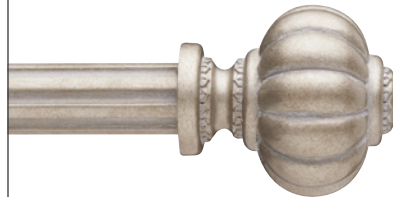

F138-7
3 5/8"L x 3 1/4"W, 1 7/8" base
630 Ash Gray
pictured with pole WG38



F138-2
4 7/8"L x 3 1/8"W, 1 7/8" base
620 Weathered Iron
pictured with pole WNF38



F138-1
4 7/8"L x 2 7/8"W, 2" base
610 Cobalt Bronze
pictured with pole WR38

1 3/8"
wood & resin

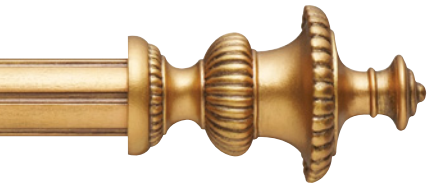

RF86
5"L x 3"W, 1 3/4" base
750 Polished Gold
pictured with WNF38



F138-4C
crystal finial
3 1/4"L x 3 3/4"W (2 5/8" Sq),
1 7/8" base
740 Smoky Mocha
pictured with pole WS38

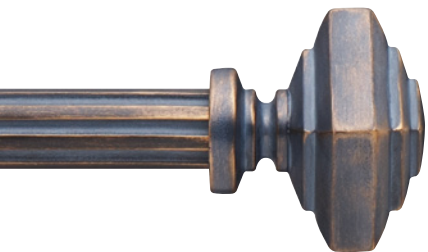

F138-4S
3 1/4"L x 3 3/4"W (2 5/8" Sq),
1 7/8" base
790 Vintage Bronze
pictured with pole WG38



F138-6
3 1/4"L x 3 1/2"W, 1 7/8" base
600 Gilded Red
pictured with pole WS38

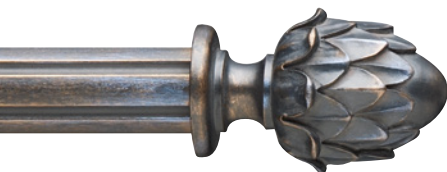

WW190
4 1/4"L x 2 1/2"W, 1 3/4" base
610 Cobalt Bronze
pictured with pole WNF38



GB4
crystal finial
4"L x 2 1/2"W, 1 3/4" base
109 Flat Black
pictured with pole WS38



138EC
wood finial
1 1/4"L x 2 3/8"W, 2 3/8" base
240 Walnut
pictured with pole WS38

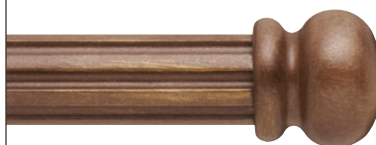

38EC
wood finial
1 1/2"L x 1 7/8"W, 1 7/8" base
780 Hazelwood
pictured with pole WG38



387
wood finial
3"L x 2 3/8"W, 1 7/8" base
720 Tawny Oak
pictured with pole WNF38

brackets

1 3/8"
wood & resin



38B
wood bracket, single
2 1/2" return, 1"W x 4 1/4"L backplate

WWB3
wood bracket, single
3 1/2" return, 1"W x 4 1/4"L backplate



38EB3
wood bracket, single
3 1/2" return, 2"Dia backplate

38EB5
wood bracket, single
6 3/4" return, 2 3/8"Dia backplate



38ISM
1 3/8" inside mount wood brackets
1 7/8"H x 1 7/8"W backplate, 1 3/8" Deep,
1/2" thick backplate per bracket
(sold in pairs)



BKT118-138
adjustable steel bracket, single
3 5/8"-4 7/8" return, 1"W x 3 1/4"L backplate



A17535
steel bracket, single,
3 1/2" return, 3/4"W x 2 1/2"L backplate



TFCS138WSSBK **NEW**
steel bracket, single
3 1/2" return, 3/4"W x 3 3/4"L backplate

A1756
steel bracket, single
6" return, 3/4"W x 2 1/2"L backplate

TFCS138WSS6BK **NEW**
steel bracket, double
6" return, 3/4"W x 3 3/4"L backplate



TFCS138WSDBK **NEW**
steel bracket, double
6" front and 3" back return,
3/4"W x 3 3/4"L backplate



TFCS138GRSBK **NEW**
steel bypass bracket, single
3 1/2" return, 3/4"W x 3 3/4"L backplate



TFCS138GRDBK **NEW**
steel bypass bracket, double
6" front and 3" back return,
3/4"W x 3 3/4"L backplate



TFCS138MCMBK **NEW**
1 3/8" steel ceiling mount bracket
2"Dia ceiling plate, 2 3/4"H, 2 5/8" drop
(distance from ceiling to bottom of pole)

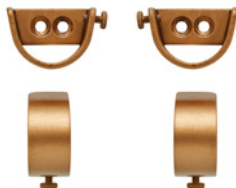

TFCS138MIBK **NEW**
1 3/8" steel inside mount brackets
1 1/4"H x 1 7/8"W backplate, 1" Deep,
1/4" thick backplate per bracket
(sold in pairs)



TFRC138REL **NEW**
1 3/8" hinged elbow
4"L (2 2/3"L each side when bent),
1 3/8" base

Return distance is from wall to center of cradle. Steel brackets shown in 680 Aged Gold. Wood brackets shown in 117 Walnut Gold.

custom solutions: brackets

The Finial Company is known for quality craftsmanship and can create custom brackets to match your job specifications. We can customize bracket dimensions, returns and finish on any pole for a custom fit on every job. For more custom solutions products see our custom brackets section on page 56.



TBKT
custom steel t-bracket, single
please specify:
A. return (distance from wall to center of cradle)
B. pole size and profile
note: 3½"H backplate comes standard, unless otherwise specified



DBL1
custom steel bracket, double
please specify:
A. front pole size and profile
B. back pole size and profile
C. rings to be used, if any
D. front and back returns (distance from wall to center of cradle)
note: returns are contingent upon which poles and rings are chosen
3½"H backplate comes standard, unless otherwise specified



BL4
custom steel ceiling mount bracket
please specify:
A. drop (distance from ceiling to top of pole)
B. pole size and profile
C. rings to be used, if any
note: minimum drop is contingent upon which finial and ring are chosen.
2½"W backplate comes standard, unless otherwise specified



FBKT
custom steel bracket, single
please specify:
A. return (distance from wall to center of cradle)
B. pole size and profile
note: 4¾"H backplate may not be modified

Return or drop distance in excess of 8" on any custom bracket will incur additional fees and requires addition of support arm. Custom brackets are shown unfinished, but will be hand painted in your selected Standard Finish (see back cover) or for a custom finish you can send us a finish sample and we'll prepare a strike-off sample for approval (see Retail Price List for custom finish charges).

rings



38FLR
fluted wood ring
2"ID, 2¾"OD



SR13
smooth steel ring
1¾"ID, 2¼"OD



FSR1
smooth heavy steel ring
1¾"ID, 2¾"OD



HSR1
hammered steel ring
1¾"ID, 2½"OD



OVL3
smooth oval steel ring
1½"ID, 2"OD, 2½"L



OVL1
hammered oval steel ring
1¾"ID, 2½"OD, 3¼"L



TFCS138MCRI NEW
smooth steel c-ring
2"ID, 2½"OD

Wood rings shown in 117 Walnut Gold.
Steel rings shown in 680 Aged Gold.

poles

1 3/8"
wood & resin



WS38 1 3/8" smooth wood

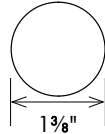

WNF38 1 3/8" fluted wood

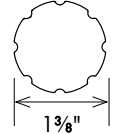

WG38 1 3/8" grooved wood

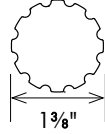

WR38 1 3/8" reeded wood

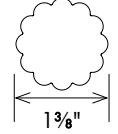

1 3/8" wood poles are sold in 2 foot increments, 2 foot minimum. Poles will be cut to specified length. Fall off will not be saved or shipped. Maximum length of all 1 3/8" wood poles is 144". Poles shown in 117 Walnut Gold.

accessories



A SBTN
steel baton, specify finish
3/8"Dia
specify length up to 60"

SBTN60
specify length up to 96"

B FBTN
fiberglass baton, white
3/8"Dia
specify length up to 48"

C ABTN-36 **NEW**
clear acrylic baton
5/8"Dia, available in 36"

ABTN-48 **NEW**
clear acrylic baton
5/8"Dia, available in 48"

D WBTN
wood baton, specify finish
3/8"Dia
specify length up to 48"

E EPBTN-1
wood baton, specify finish
5/8"Dia, handle: 6 1/8"L x 1 1/4"Dia
specify length up to 48"

F EPBTN-2
wood baton, specify finish
5/8"Dia, handle: 5 3/4"L x 1 1/2"Dia
specify length up to 48"



MB138 band, R24 rosette, WVS38 pole, finish 200 Walnut Gold with Gray Accents

MB138
metal band, attaches any rosette to front of 1 3/8"Dia pole. Use with 1 3/8" pole only. For more information on metal bands, see page 92.

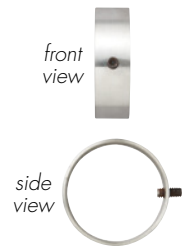



2"-2¹/₄" wood & resin

Endless design options and solutions are available in our 2"-2¹/₄" wood & resin collection. With over 20 new finial designs and the largest variety of pole, ring and bracket styles to choose from this collection is a go to for any window design need.

2" - 2 1/4" wood & resin



TFCR214190 **NEW**
1" L x 2 7/8" W, 2 7/8" base
620 Weathered Iron
pictured with pole WVWR



TFCR214191 **NEW**
1 1/2" L x 3 1/8" W, 2 7/8" base
112 Silver with Gold
pictured with pole WVWR

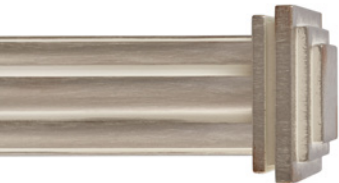

TFCR214192 **NEW**
1 1/4" L x 3 1/4" W, 2 7/8" base
810 Bronzed Ore
pictured with pole 225FL



TFCR214193 **NEW**
1 1/2" L x 3 5/8" W, 2 7/8" base
850 Soft Brass
pictured with pole 225WG



TFCR214194 **NEW**
1 3/8" L x 3" W, 2 7/8" base
790 Vintage Bronze
pictured with pole 225WS



TFCR214195 **NEW**
1 1/4" L x 3 1/8" W, 2 7/8" base
870 Chalet Gray
pictured with pole 2WG



TFCR214196 **NEW**
1 1/2" L x 3" W, 3" base
800 Charred Toasted Oak
pictured with pole WWF

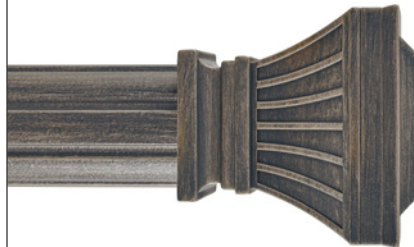

TFCR214110 **NEW**
4 3/8" L x 4 1/4" W, 2 3/4" base
860 Grayed Brass
pictured with pole 225FL



TFCR214121 **NEW**
3 1/4" L x 3 1/2" W, 2 3/4" base
840 White with Gold Accents
pictured with pole 225FL



TFCR214122 **NEW**
4 1/2" L x 4 3/4" W, 2 7/8" base
110 Flat Black with Gold
pictured with pole 225FL

2" - 2 1/4"
wood & resin



TFCR214123 **NEW**
4 5/8" L x 4 3/8" W, 2 3/4" base
620 Weathered Iron
pictured with pole 225WS



TFCR214124 **NEW**
5" L x 4 5/8" W, 2 3/4" base
112 Silver with Gold
pictured with pole 225WS



TFCR214125 **NEW**
5 3/8" L x 3 1/2" W, 2 3/4" base
760 Rustic Iron
pictured with pole WWF



TFCR214130 **NEW**
4 3/8" L x 5 1/2" W, 3" base
620 Weathered Iron
pictured with pole 225WWR

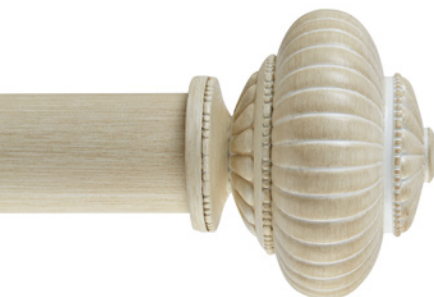

TFCR214131 **NEW**
4 5/8" L x 5 3/8" W, 2 7/8" base
880 Parchment
pictured with pole 225WS

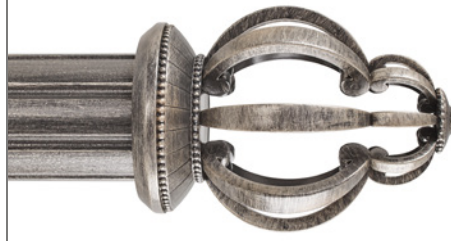

TFCS214150 **NEW**
6 1/2" L x 4" W, 2 3/4" base
860 Grayed Brass
pictured with pole
225WG

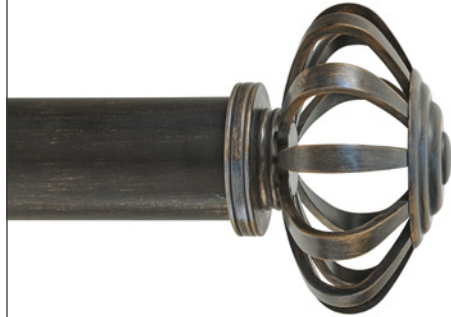

TFCS214151 **NEW**
3 7/8" L x 5 5/8" W, 2 3/4" base
610 Cobalt Bronze
pictured with pole WWR

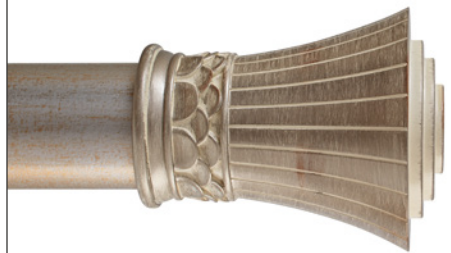

TFCR214163 **NEW**
5 3/8" L x 4 3/8" W, 2 7/8" base
810 Bronzed Ore
pictured with pole WWR



TFCR214164 **NEW**
5 1/2" L x 4 1/4" W, 2 7/8" base
112 Silver with Gold
pictured with pole 225WWR



TFCR214165 **NEW**
6 3/4" L x 4 1/8" W, 2 7/8" base
840 White with Gold
Accents
pictured with pole WWR

2" - 2 1/4" wood & resin



TFCR214170 **NEW**
glass finial
3 5/8" L x 4 3/8" W, 2 3/4" base
740 Smoky Mocha
pictured with pole 225WS



TFCR214171 **NEW**
glass finial
3 5/8" L x 4 3/8" W, 2 7/8" base
810 Bronzed Ore
pictured with pole 225WG

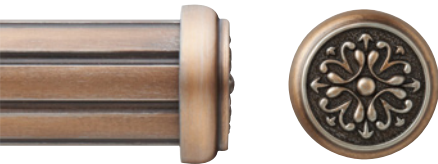

REC73
7/8" L x 2 3/4" W, 2 3/4" base
760 Rustic Iron
pictured with pole 225FL



EC214-1
1 3/8" L x 2 7/8" W, 2 7/8" base
600 Gilded Red
pictured with pole 225WG



F214-12
2" L x 3" W, 2 7/8" base
660 Antique White
pictured with pole 225WR



F214-2
2 1/4" L x 3 1/2" W, 3" base
610 Cobalt Bronze
pictured with pole 225WG
coordinates with rosette ROS-3



F214-3
3 3/4" L x 4" W, 2 7/8" base
107 Bronze with Gold
and Gray
pictured with pole 225FL
coordinates with rosette ROS-3



F214-4
2 7/8" L x 3 1/2" W, 2 3/4" base
640 Oil Rubbed Bronze
pictured with pole 225WS

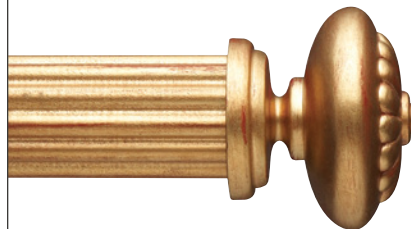

F214-1
3 1/2" L x 4" W, 2 7/8" base
600 Gilded Red
pictured with pole 225VWR

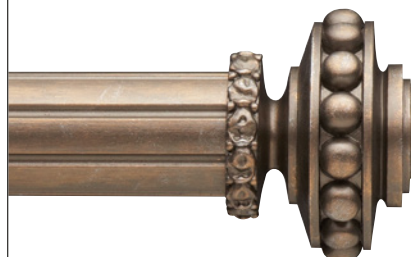

F214-7
3 5/8" L x 4 1/2" W, 3" base
690 Champagne
pictured with pole 225FL

2" - 2 1/4"
wood & resin

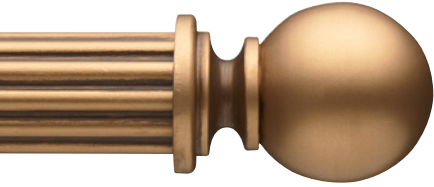

F214-8
4 5/8"L x 3 1/4"W, 2 7/8" base
680 Aged Gold
pictured with pole 225WWR



F214-9
4 3/4"L x 4 5/8"W, 3 1/8" base
710 Tarnished Silver
pictured with pole 225WG



RF63
3"L x 2 3/4"W, 2 1/2" base
610 Cobalt Bronze
pictured with pole 225WS



F214-10
4 1/2"L x 4 1/8"W, 3" base
620 Weathered Iron
pictured with pole 225FL

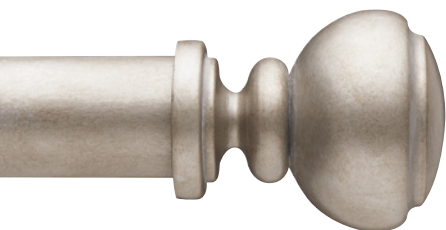

F214-11
4 7/8"L x 4"W, 2 7/8" base
630 Ash Gray
pictured with pole 225WS



F214-6
5 1/2"L x 4"W, 2 7/8" base
670 Espresso
pictured with pole 225WS



F214-5
7"L x 4 3/4"W, 3" base
620 Weathered Iron
pictured with pole 225WWR
coordinates with rosette ROS-5



F214-14
4 7/8"L x 3 1/2"W, 2 7/8" base
640 Oil Rubbed Bronze
pictured with pole 225WG



F214-15S
4"L x 4 1/8"W, 2 7/8" base
155 Antique
pictured with pole 225WWR
coordinates with rosette ROS-1S



F214-15C
crystal finial
4"L x 4 1/8"W, 2 7/8" base
106 Bronze with Gold
pictured with pole 225WS
coordinates with rosette ROS-1C



F214-13
4"L x 4 1/8"W, 2 7/8" base
790 Vintage Bronze
pictured with pole 225WR

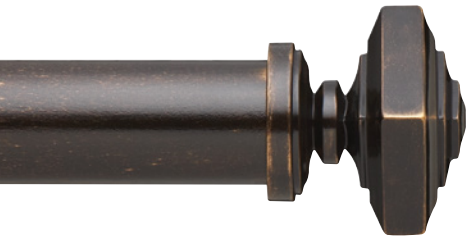

F214-16S
3 5/8"L x 4 1/8"W (3"Sq),
2 7/8" base
350G Statuary Bronze
with Gold
pictured with pole 225WS
coordinates with rosette
ROS-6S



F214-16C
crystal finial
3 5/8"L x 4 1/8"W (3"Sq),
2 7/8" base
630 Ash Gray
pictured with pole
225WG
coordinates with rosette
ROS-6C



GB2
crystal finial
5 1/4"L x 3 3/8"W, 2 1/2" base
250 Platinum
pictured with pole WWR



RF1000
7 1/4"L x 3"W, 2 3/4" base
780 Hazelwood
pictured with pole 225FL



WW51
5 1/2"L x 3 5/8"W, 2 1/2" base
200 Walnut Gold with
Gray Accents
pictured with pole 225WG



Y10
7"L x 3 3/4"W, 2 1/2" base
107 Bronze with Gold
and Gray
pictured with pole
225WG

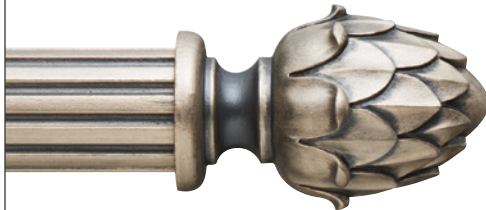

WW207
5 7/8"L x 3 3/4"W, 2 1/2" base
710 Tarnished Silver
pictured with pole 225WG



WW60-1
2 7/8"L x 3 1/2"W, 3 1/2" base
660 Antique White
pictured with pole 225WG



WW205
4"L x 3 1/2"W, 2 1/2" base
670 Espresso
pictured with pole 225WS

2" - 2 1/4"
wood & resin



R22569
6"L x 3 1/2"W, 2 1/2" base
650 Hickory
pictured with pole 225WS



225MC9
4 3/8"L x 4 1/4"W, 2 1/2" base
600 Gilded Red
pictured with pole 225WG

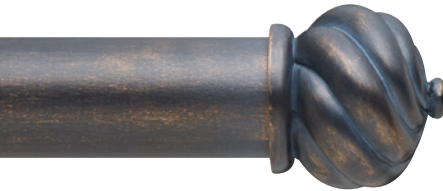

WW9
3"L x 3 3/8"W, 2 7/8" base
790 Vintage Bronze
pictured with pole 225WS



WW70-1
6 1/2"L x 5 1/4"W, 2 1/2" base
610 Cobalt Bronze
pictured with pole 225WR
coordinates with rosette R8



WW47-1
5 3/4"L x 3 1/2"W, 2 1/2" base
720 Tawny Oak
pictured with pole 225FL



WW201
5"L x 2 3/4"W, 2 3/4" base
750 Polished Gold
pictured with pole
225WWR



RF10
6 1/2"L x 3 1/2"W, 2 3/4" base
200 Walnut Gold with Gray
pictured with pole 2WR



225MC11
4"L x 5"W, 2 1/2" base
107 Bronze with Gold
and Gray
pictured with pole
225WR
coordinates with rosette
RMC11



GB1
glass finial
5"L x 3"W, 2 1/2" base
109 Flat Black
pictured with pole WWR



WW34-1
7"L x 4 1/2"W, 2 3/4" base
690 Champagne
pictured with pole 225WR



WW35
6 1/2" L x 4 3/4" W, 2 3/4" base
690 Champagne
pictured with pole 225FL



225MC13
3 3/4" L x 4 7/8" W, 2 1/2" base
640 Oil Rubbed Bronze
pictured with pole 225VWWR
coordinates with rosette RMC13



WW251
3 3/4" L x 2 3/4" W, 2 3/8" base
760 Rustic Iron
pictured with pole 2WG

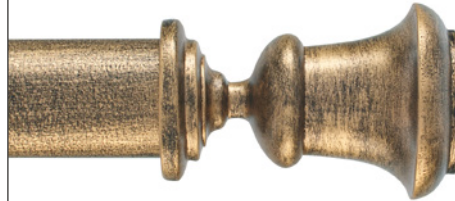

WW23
5" L x 2 3/4" W, 2 1/4" base
155 Antique
pictured with pole VWWR



WW203
5" L x 3 1/4" W, 2 5/8" base
790 Vintage Bronze
pictured with pole 225WR



GB3
glass finial
6" L x 4" W, 2 3/4" base
320 Pewter
pictured with pole 225WS



RD225
6" L x 5 1/2" W, 3 1/4" base
155 Antique
pictured with pole 225WS

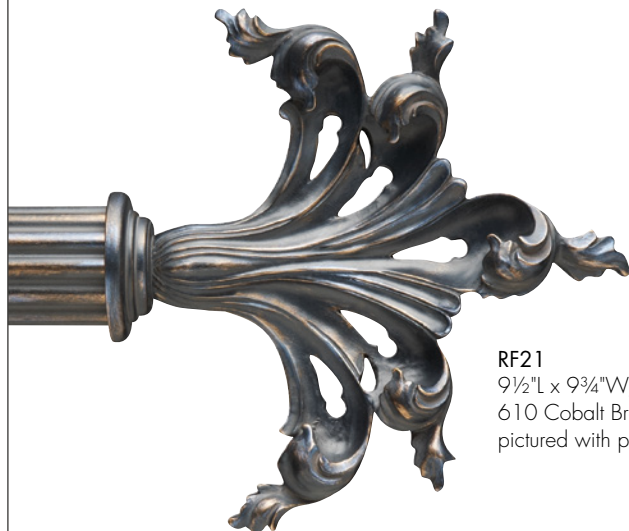

RF21
9 1/2" L x 9 3/4" W, 2 3/4" base
610 Cobalt Bronze
pictured with pole 225VWWR



RF20
7 1/4" L x 5" W, 2 1/2" base
710 Tarnished Silver
pictured with pole 225WG

2" - 2 1/4" wood & resin



RF64
2 5/8" L x 2 3/8" W, 2 1/2" base
770 Bronze Patina
pictured with pole VVWF
coordinates with rosette R64



EP8
5 5/8" L x 3 5/8" W, 2 3/4" base
610 Cobalt Bronze
pictured with pole 225WR



W551
wood finial
5 1/2" L x 3 1/2" W, 2 1/4" base
240 Walnut
pictured with pole 225WG



EP1
6" L x 3 1/4" W, 2 1/2" base
330 Bronze with Black
pictured with pole 2WG
coordinates with rosette REP1

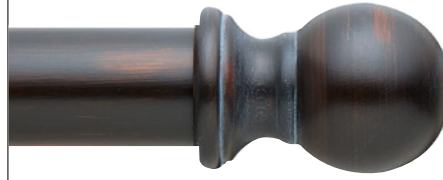

WW77
wood finial
4 5/8" L x 3" W, 3" base
670 Espresso
pictured with
pole 225WS



2EC
wood finial
1 1/8" L x 3" W, 3" base
650 Hickory
pictured with pole VVWR
fits 2" Dia pole only



225EC
wood finial
1 1/8" L x 2 3/4" W, 2 3/4" base
720 Tawny Oak
pictured with pole 225WS

decorative 2" & 2 1/4" brackets



LFB3
resin bracket, single
3 1/2" return, 1" W x 4 5/8" L backplate

LFB4
resin bracket, single
6" return, 1" W x 4 5/8" L backplate



DB76
resin bracket, single
3 3/4" return, 1 1/4" W x 8 5/8" L
backplate



DB78
resin bracket, single
3 3/4" return, 1 1/4" W x 8 5/8" L
backplate



DB80
resin bracket, single
3 1/2" return, 2 1/2" W x 2 7/8" L
backplate

*Return distance is from wall to center of cradle.
Resin brackets shown in 810 Bronzed Ore.*

brackets

2"-2¹/₄"
wood & resin

2" brackets



WWB1
wood bracket, single
3¹/₂" return, 1"W x 4³/₄"L backplate

WWB2
wood bracket, single
6" return, 1"W x 4³/₄"L backplate



EB24
wood bracket, single
4" return, 2³/₄"Dia backplate

EB26
wood bracket, single
6¹/₂" return, 2³/₄"Dia backplate



CSB1
wood bracket, single
3³/₄" return, 1"W x 4³/₄"L backplate

CSB2
wood bracket, single
6" return, 1"W x 4³/₄"L backplate

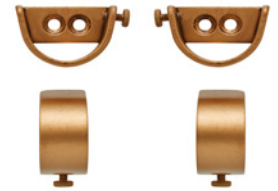

TFCS200MIBK **NEW**
2" steel inside mount brackets,
1¹/₂"H x 2³/₄"W backplate, 1"Deep,
¹/₄" thick backplate per bracket
(sold in pairs)



TFCS200MCMBK **NEW**
2" steel ceiling mount bracket
3¹/₄"W x 3³/₄"H ceiling plate,
3⁵/₈" drop (distance from ceiling to
bottom of pole)



TFRC200REL **NEW**
2" hinged elbow,
4⁵/₈"L, (3¹/₄"L each side when bent)
2¹/₈" base

2¹/₄" brackets



225WB1
wood bracket, single
3¹/₂" return, 1"W x 4³/₄"L backplate

225WB2
wood bracket, single
6" return, 1"W x 4³/₄"L backplate



EB2254
wood bracket, single
4" return, 1⁷/₈"Dia backplate

EB2256
wood bracket, single
7" return, 1⁷/₈"Dia backplate



225WCS1
wood bracket, single
3¹/₂" return, 1"W x 3¹/₂"L backplate

225WCS2
wood bracket, single
6" return, 1"W x 3¹/₂"L backplate

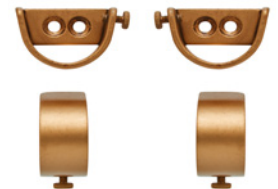

TFCS214MIBK **NEW**
2¹/₄" steel inside mount brackets
1¹/₂"H x 2³/₄"W backplate, 1"Deep,
¹/₄" thick backplate per bracket
(sold in pairs)



TFCS214MCMBK **NEW**
2¹/₄" steel ceiling mount bracket
3¹/₄"W ceiling plate, 3³/₄"H,
3⁵/₈" drop (distance from ceiling to
bottom of pole)



TFRC214REL **NEW**
2¹/₄" hinged elbow,
5"L, (3³/₄"L each side when bent)
2¹/₂" base

*Return distance is from wall to center of cradle.
Steel brackets shown in 680 Aged Gold.
Wood brackets shown in 117 Walnut Gold.*

2" & 2 1/4" brackets



BKT200-214
adjustable steel bracket, single
3 7/8"-5" return, 1"W
x 3 1/2"L backplate



WL1
steel bracket, single
3 3/4" return, 3/4"W
x 2 1/2"L backplate

WL2
steel bracket, single
6" return, 3/4"W
x 2 1/2"L backplate



WL4
steel bracket, single
3 1/2" return, 3/4"W
x 4 1/4"L backplate

WL5
steel bracket, single
6" return, 3/4"W
x 4 1/4"L backplate



CSWB1
steel bracket, single
3 1/2" return, 3 1/2"W x 1 1/2"H
backplate

CSWB2
steel bracket, single
6" return, 3 1/2"W x 1 1/2"H
backplate



EB7
steel eyelet bracket, single
3 1/2" return, 1"W x 3 1/2"L
backplate, eyelet 2 3/8"ID

EB8
steel eyelet bracket, single
6" return, 1"W x 3 1/2"L
backplate, eyelet 2 3/8"ID

Return distance is from wall to center of cradle. Steel brackets shown in 680 Aged Gold.

custom solutions: brackets

The Finial Company is known for quality craftsmanship and can create custom brackets to match your job specifications. We can customize bracket dimensions, returns and finish on any pole for a custom fit on every job. For more custom solutions products see our custom brackets section on page 56.



TBKT
custom steel t-bracket, single
please specify:
A. return (distance from wall
to center of cradle)
B. pole size and profile
note: 3 1/2"H backplate comes
standard, unless otherwise
specified



DBL1
custom steel bracket, double
please specify:
A. front pole size and profile
B. back pole size and profile
C. rings to be used, if any
D. front and back returns
(distance from wall to
center of cradle)
note: returns are contingent upon
which poles and rings are chosen
3 1/2"H backplate comes
standard, unless otherwise
specified



BL4
custom steel ceiling mount
bracket
please specify:
A. drop (distance from
ceiling to top of pole)
B. pole size and profile
C. rings to be used, if any
note: minimum drop is contingent
upon which finial and ring are
chosen.
2 1/2"W backplate comes
standard, unless otherwise
specified



FBKT
custom steel bracket, single
please specify:
A. return (distance from wall
to center of cradle)
B. pole size and profile
note: 4 3/4"H backplate may not
be modified

Return or drop distance in excess of 8" on any custom bracket will incur additional fees and requires addition of support arm. Custom brackets are shown unfinished, but will be hand painted in your selected Standard Finish (see back cover) or for a custom finish you can send us a finish sample and we'll prepare a strike-off sample for approval (see Retail Price List for custom finish charges).

rings

rings for 2" poles



WWRG
fluted wood ring
2 3/4" ID, 3 7/8" OD



SR7
smooth steel ring
2 1/4" ID, 2 3/4" OD



OVL7
smooth oval steel ring
2 1/4" ID, 2 3/4" OD, 3 1/2" L

rings for 2" & 2 1/4" poles



225-RWR
fluted wood ring
2 3/4" ID, 4 1/4" OD



SR12
smooth steel ring
2 1/2" ID, 3" OD



OVL12
smooth oval steel ring
2 1/2" ID, 3 1/4" OD, 4" L



HSR2
hammered steel ring
2 1/2" ID, 3 1/4" OD



SR5
twisted steel ring
2 1/2" ID, 3" OD



OVL2
hammered oval steel ring
2 1/2" ID, 3 1/2" OD, 4" L



DRRG3
leafy resin ring
3" ID, 4 1/2" OD

Wood rings shown in 117 Walnut Gold.
Steel rings shown in 680 Aged Gold.
Resin ring shown in 107 Bronze with Gold and Gray.

2" - 2 1/4"
wood & resin

poles



WWR 2" smooth wood
225WS 2 1/4" smooth wood



2WG 2" grooved wood
225WG 2 1/4" grooved wood



WWF 2" fluted wood
225FL 2 1/4" fluted wood



2WR 2" reeded wood
225WR 2 1/4" reeded wood



225WWR 2 1/4" wide reeded wood



2" and 2 1/4" wood poles are sold in 2 foot increments, 2 foot minimum.
Poles will be cut to specified length. Fall off will not be saved or shipped.
Maximum length of all 2" and 2 1/4" wood poles is 192".
Poles shown in 117 Walnut Gold.

accessories



- A SBTN**
steel baton, specify finish
3/8" Dia
specify length up to 60"
SBTN60
specify length up to 96"
- B FBTN**
fiberglass baton, white
3/8" Dia
specify length up to 48"
- C ABTN-36** NEW
clear acrylic baton
3/8" Dia, available in 36"
- ABTN-48** NEW
clear acrylic baton
3/8" Dia, available in 48"
- D WBTN**
wood baton, specify finish
3/8" Dia
specify length up to 48"
- E EPBTN-1**
wood baton, specify finish
3/8" Dia, handle: 6 1/8" L x 1 1/4" Dia
specify length up to 48"
- F EPBTN-2**
wood baton, specify finish
3/8" Dia, handle: 5 3/4" L x 1 1/2" Dia
specify length up to 48"



MB214 band, R-2 rosette, 225VWG pole, finish 710 Tarnished Silver

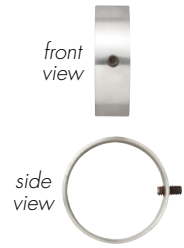

MB214
metal band, attaches any rosette to front of 2 1/4" diameter pole. Use with 2 1/4" pole only. For more information on metal bands, see page 92.



3" wood & resin

If you are looking to make a statement, our 3" wood & resin collection offers stately scale in striking designs to cover even the grandest of windows. With six new finial designs to select from, you can create modern to traditional window designs of great distinction.

3"

wood & resin



TFCR300190 **NEW**
1 1/4"L x 3 3/4"W, 3 3/4" base
112 Silver with Gold
pictured with pole 3GR



TFCR300192 **NEW**
1 1/2"L x 3 7/8"W, 3 3/4" base
110 Flat Black with Gold
pictured with pole 3GR



EC300-1
1 1/2"L x 3 3/4"W, 3 3/4" base
670 Espresso
pictured with pole 3SM



3EC
wood finial
1 1/8"L x 3 3/4"W, 3 3/4" base
670 Espresso
pictured with pole 3SM

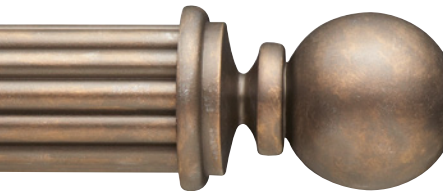

F300-2
5 1/2"L x 3 3/4"W, 3 3/4" base
690 Champagne
pictured with pole 3RD



TFCR300124 **NEW**
5 3/8"L x 5 1/4"W,
3 3/4" base
800 Charred Toasted
Oak
pictured with pole 3SM



TFCR300130 **NEW**
5 1/4"L x 5 7/8"W, 3 3/4" base
860 Grayed Brass
pictured with 3RD pole

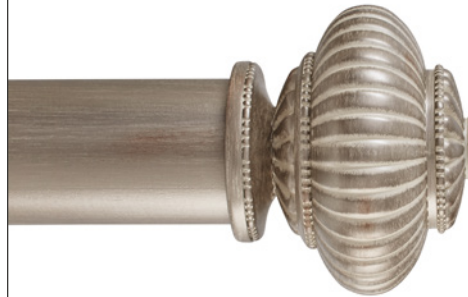

TFCR300131 **NEW**
5"L x 6"W, 3 3/4" base
810 Bronzed Ore
pictured with pole 3SM



TFCR300121 **NEW**
3 3/4"L x 4 1/4"W, 3 5/8" base
150 Gray with Gold
pictured with pole 3SM



F300-3
3⁷/₈"L x 4¹/₂"W, 3³/₈" base
680 Aged Gold
pictured with pole 3SM



F300-4C
crystal finial
4¹/₈"L x 4¹/₄"W, 3³/₈" base
640 Oil Rubbed Bronze
pictured with pole 3SM
coordinates with rosette ROS-1C



F300-4S
4¹/₈"L x 4¹/₄"W, 3³/₈" base
106 Bronze with Gold
pictured with pole 3SM
coordinates with rosette ROS-1S



R369
8¹/₂"L x 5¹/₄"W, 3¹/₂" base
320 Pewter
pictured with pole 3SM



WW26-1
5¹/₂"L x 3³/₄"W, 3³/₄" base
117 Walnut Gold
pictured with pole 3RD



3RF10
7¹/₄"L x 4"W, 3¹/₄" base
760 Rustic Iron
pictured with pole 3RD



3RF86
7"L x 5¹/₄"W, 3³/₄" base
270 Mahogany Rust
pictured with pole 3RD



3R9
4"L x 4"W, 3³/₈" base
750 Polished Gold
pictured with pole 3SM



WW75
7¹/₂"L x 4¹/₈"W, 3³/₈" base
600 Gilded Red
pictured with pole 3SM



3RY10
8¹/₄"L x 4¹/₂"W, 4" base
610 Cobalt Bronze
pictured with pole 3GR

3"

wood & resin



3W100
8"L x 4½"W, 3½" base
107 Bronze with
Gold and Gray
pictured with pole 3GR



3RF20
11¼"L x 7¼"W, 3¾" base
155 Antique
pictured with pole 3GR



F300-1
6¼"L x 4¾"W, 3½" base
650 Hickory
pictured with pole 3GR



RD3
7¾"L x 7"W, 4" base
790 Vintage Bronze
pictured with pole 3GR



F513
7"L x 4"W, 3¼" base
660 Antique White
pictured with pole 3GR



3R35
8½"L x 6½"W, 3¾" base
155 Antique
pictured with pole 3GR



3MC11
3"L x 5½"W, 3½" base
700 Graphite
pictured with pole 3SM
*coordinates with rosette
RMC11*

brackets

3"
wood & resin



3LFB1
resin bracket, single
4½" return, 1"W x 4¾"L backplate

3LFB2
resin bracket, single
6" return, 1"W x 5¼"L backplate



DB77
resin bracket, single
4¼" return, 2½"W x 2¾"L backplate



DB79
resin bracket, single
4¼" return, ¾"W x 2¼"L backplate



3WB1
wood bracket, single
4½" return, 1½"W x 4¾"L backplate

3WB2
wood bracket, single
6" return, 1½"W x 4¾"L backplate



3EB4
wood bracket, single
4¼" return, 3½"Dia backplate



3CSB1
wood bracket, single
4½" return, 1½"W x 3¾"L backplate

3CSB2
wood bracket, single
6" return, 1½"W x 3¾"L backplate



3L1
steel bracket, single
3½" return, ¾"W x 2¾"L backplate

3L2
steel bracket, single
4½" return, ¾"W x 2¾"L backplate

3L3
steel bracket, single
6" return, ¾"W x 2¾"L backplate



3L5
steel bracket, single
3¾" return, ¾"W x 3½"L backplate

3L6
steel bracket, single
6" return, ¾"W x 4¼"L backplate



3-LELB
3" hinged elbow
4¾"L, (4"L each side when bent),
3" base

*Return distance is from wall to center of cradle.
Wood brackets shown in 117 Walnut Gold.
Steel brackets shown in 680 Aged Gold.
Resin brackets shown in 810 Bronzed Ore.*

custom solutions: brackets

The Finial Company is known for quality craftsmanship and can create custom brackets to match your job specifications. We can customize bracket dimensions, returns and finish on any pole for a custom fit on every job. For more custom solutions products see our custom brackets section on page 56.



TBKT
custom steel t-bracket, single
please specify:
A. return (distance from wall to center of cradle)
B. pole size and profile
note: 3½"H backplate comes standard, unless otherwise specified



DBL1
custom steel bracket, double
please specify:
A. front pole size and profile
B. back pole size and profile
C. rings to be used, if any
D. front and back returns (distance from wall to center of cradle)
note: returns are contingent upon which poles and rings are chosen
3½"H backplate comes standard, unless otherwise specified



BL4
custom steel ceiling mount bracket
please specify:
A. drop (distance from ceiling to top of pole)
B. pole size and profile
C. rings to be used, if any
note: minimum drop is contingent upon which finial and ring are chosen.
2½"W backplate comes standard, unless otherwise specified



FBKT
custom steel bracket, single
please specify:
A. return (distance from wall to center of cradle)
B. pole size and profile
note: 4¾"H backplate may not be modified

Return or drop distance in excess of 8" on any custom bracket will incur additional fees and requires addition of support arm. Custom brackets are shown unfinished, but will be hand painted in your selected Standard Finish (back cover) or for a custom finish you can send us a finish sample and we'll prepare a strike-off sample for approval (see Retail Price List for custom finish charges).

rings



WRG3
fluted wood ring
3¾"ID, 5¼"OD



SR11
smooth steel ring
3½"ID, 4"OD



HSR3
hammered steel ring
3¾"ID, 4¼"OD



DRRG4
leafy resin ring
3½"ID, 5¼"OD

Wood rings shown in 680 Aged Gold.
Steel rings shown in 117 Walnut Gold.
Resin ring shown in 107 Bronze with Gold and Gray.

poles



3SM 3" smooth wood

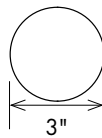

3GR 3" grooved wood

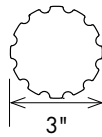

3RD 3" reeded wood

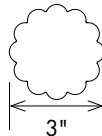

3" wood poles are sold in 2 foot increments, 2 foot minimum. Poles will be cut to specified length. Fall off will not be saved or shipped. Maximum length of all 3" wood poles is 192". Poles shown in 117 Walnut Gold finish.

accessories



- A SBTN**
steel baton, specify finish
3/8"Dia
specify length up to 60"
- SBTN60**
specify length up to 96"
- B FBTN**
fiberglass baton, white
3/8"Dia
specify length up to 48"
- C ABTN-36** **NEW**
clear acrylic baton
5/8"Dia, available in 36"
- ABTN-48** **NEW**
clear acrylic baton
5/8"Dia, available in 48"
- D WBTN**
wood baton, specify finish
3/8"Dia
specify length up to 48"
- E EPBTN-1**
wood baton, specify finish
5/8"Dia, handle: 6 1/8"L x 1 1/4"Dia
specify length up to 48"
- F EPBTN-2**
wood baton, specify finish
5/8"Dia, handle: 5 3/4"L x 1 1/2"Dia
specify length up to 48"



rosettes

Design is in the details, and The Finial Company offers a wide range of rosettes that can be used to customize the design and functionality of your window treatment. Rosettes can be used as a decorative detail to hold back draperies, added to the front of any standard or custom steel bracket to accentuate the design of your pole or added to a custom tieback arm as the perfect complement to your window design.

rosettes



R-RND
1 1/4" Dia, steel
109 Flat Black



SEC-125
1 1/4" Dia, steel
750 Polished Gold



EC4
1 1/4" Dia, steel
690 Champagne



RF4
1 1/8" Dia, resin
680 Aged Gold



EC3
2" Dia, brass
710 Tarnished Silver



SEC-2
2" Dia, steel
790 Vintage Bronze



REC73
2 3/4" Dia, resin
107 Bronze with Gold
and Gray



R-16 OH
3" Dia, steel
110 Flat Black with Gold



R23
3 1/2" Dia, steel
250 Platinum



R18
3 1/2" Dia, resin
760 Rustic Iron



R15
3 3/4" Dia, resin
720 Tawny Oak



RMC13
3 5/8" Dia, resin
740 Smoky Mocha
coordinates with finial 225MC13



R11
4" Dia, resin
770 Bronze Patina



REP1
4 1/8" Dia, resin
760 Rustic Iron
coordinates with finial EP1



R5
4 1/4" Dia, resin
155 Antique



WR30
4 1/4" Dia, wood
720 Tawny Oak

rosettes



R-21
2 $\frac{7}{8}$ "Dia, steel
107 Bronze with
Gold and Gray



R24
3"Dia, resin
200 Walnut Gold with
Gray Accents



R65
3"Dia, resin
112 Silver with Gold



R64
3"Dia, resin
106 Bronze with Gold
coordinates with finial RF64



ROS-1S
3 $\frac{3}{4}$ "Dia, resin
640 Oil Rubbed Bronze
*coordinates with finials
F214-15S and F300-4S*



R-22
3 $\frac{3}{4}$ "Dia, steel
700 Graphite



ROS-2
4"Dia, resin
610 Cobalt Bronze
coordinates with finial F138-6



ROS-6C
3"Sq, 4 $\frac{1}{4}$ "Diagonal, crystal
760 Rustic Iron
*coordinates with finials
F138-4C and F214-16C*



ROS-1C
3 $\frac{3}{4}$ "Dia, crystal
670 Espresso
*coordinates with finial
F214-15C and F300-4C*



ROS-6S
3"Sq, 4 $\frac{1}{4}$ "Diagonal, resin
720 Tawny Oak
coordinates with finials F138-4S F214-16S



RMC11
4 $\frac{1}{4}$ "Dia, resin
107 Bronze with Gold and Gray
coordinates with finial 225MC11



R-2
4 $\frac{1}{2}$ "Dia, resin
630 Ash Gray



R73
4 $\frac{1}{2}$ "Dia, resin
610 Cobalt Bronze

rosettes



R10
4¾" Sq, 7" Diagonal, resin
117 Walnut Gold



R-17
4¾" Dia, steel
690 Champagne



ROS-3
5" Dia, resin
620 Weathered Iron
coordinates with finials F214-2 and F214-3



R8
5" Dia, resin
710 Tarnished Silver
coordinates with finial WW70



R-107
5¼" Dia, steel
790 Vintage Bronze



R101 **OH**
5½" Dia, brass
270 Mahogany Rust with custom gold*



ROS-5
6" Dia, resin
730 Rose Gold
coordinates with finials F2145 and F300-3



ROS-4
5¾" Dia, resin
740 Smoky Mocha

*Please note: there is an upcharge for this custom finish; please refer to Retail Price List for details.

rosettes

accessories

metal bands

attach any rosette to the front of a pole

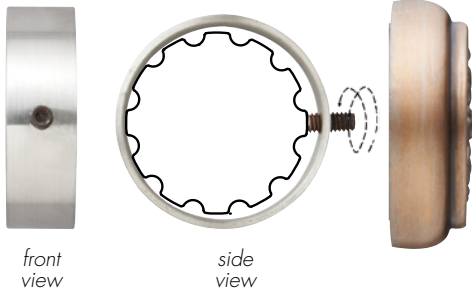

Metal band slides onto pole and is locked in place with set screw. Set screw should be positioned in the front center of pole because it receives the rosette.

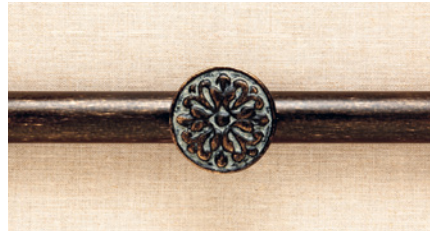

MB100

1" Dia metal band attaches any rosette to front of a 1" Dia pole
rosettes sold separately
shown: EC3 rosette on RR100 pole, finish 620 Weathered Iron



MB138

1 3/8" Dia metal band attaches any rosette to front of a 1 3/8" Dia pole
rosettes sold separately
shown: R24 rosette on WS38 pole, finish 200 Walnut Gold with Gray Accents

hold gathered rod pocket fabric panel in place

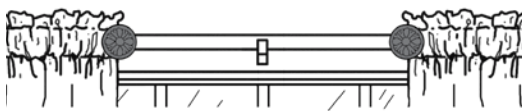

MB214

2 1/4" Dia metal band attaches any rosette to front of a 2 1/4" Dia pole
rosettes sold separately
shown: R2 rosette on 225WG pole, finish 710 Tarnished Silver

rosette posts & brackets



steel tieback post for rosettes
backplate 1 3/4" Dia

NBL2	2 1/2" projection
NBL4	3 1/2" projection
NBL6	6" projection

OH



wood tieback post for rosettes
base 1 5/8" Dia

WTBS2	2 1/2" projection
WTBS4	4 1/4" projection
WTBS6	6" projection



steel brackets for rosettes
backplate 2 1/4" H x 1/2" W

BL2	2 1/2" projection
BL3	3 1/2" projection
BL6	6" projection



STBA7
9½"L x 5" projection
810 Bronzed Ore



STB
10"L x 4¾"W
640 Oil Rubbed Bronze



TTBH-1 OH
4½"L x 1¼" projection
790 Vintage Bronze



TTBH-2 OH
3½"L x 1¼" projection
330 Bronze with Black

OH item is available in *Outdoor Hardware*, pages 45-48

custom solutions: create tiebacks from any finial or rosette

Don't see what your looking for? Just ask our custom shop & we'll make it. For more custom product options, see our Custom Solutions section beginning on page 49.



TBA
6"L back arm x 4½"L front arm,
4½" projection
100 Polished Steel*
attach finial or rosette of choice to face
or tip of TBA pictured with L651 finial
finial sold separately



STBA1
8"L back arm x 8"L front arm,
6½" projection
610 Cobalt Bronze
attach finial or rosette of choice
pictured with R73 rosette
rosette sold separately

**please note: there is an upcharge for this custom finish; please refer to Retail Price List for details.*

standard



C1
20"W x 8¾"H
155 Antique
pictured with WW201 finials and 225WVR pole



C2
23¾"W x 9"H
112 Silver with Gold



C6
26¼"W x 7½"H
810 Bronzed Ore



C7
16½"W x 7¼"H
710 Tarnished Silver



C8
27½"W x 15¼"H
155 Antique

pole mount slide onto pole



C3
14¾"W x 6"H
155 Antique
pictured with RD3 finials in 155 Antique and 3RD pole in 109 Flat Black; *use with 3" pole only*



C4
10⅞"W x 4¼"H
155 Antique
pictured with RD225 finials in 155 Antique and 225WR pole in 109 Flat Black; *use with 2¼" pole only*



traverse systems

light duty traverse	95
heavy duty traverse	98
motorized traverse	102
how to order traverse	108

HAND-DRAW TRAVERSE FASCIA

cuts for light duty and heavy duty systems

MOTORIZED TRAVERSE FASCIA

cuts for Somfy Glydea and BTX DC systems

FLAT &
SLIM

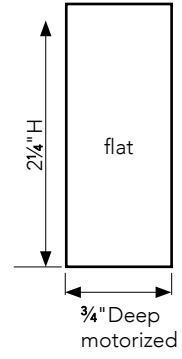
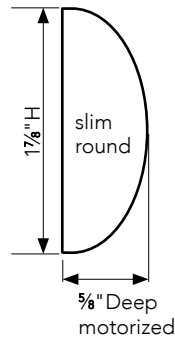
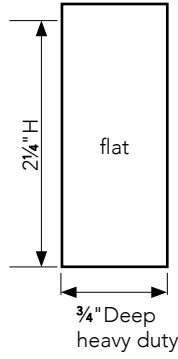
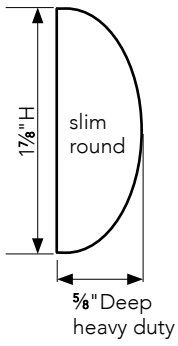

2"

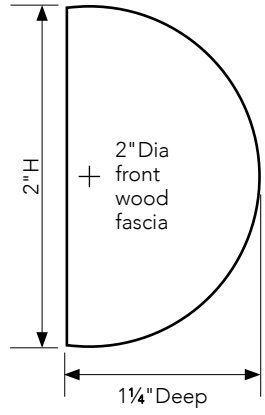
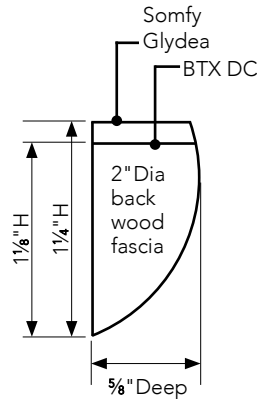
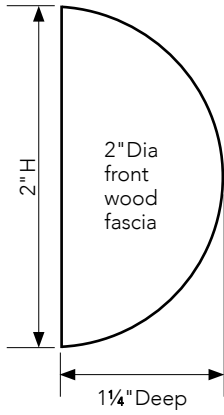
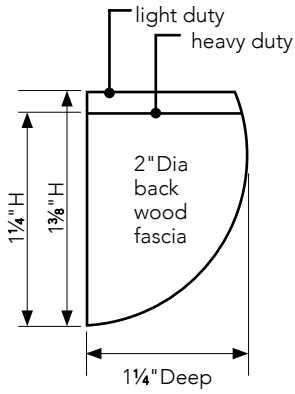

2 1/4"

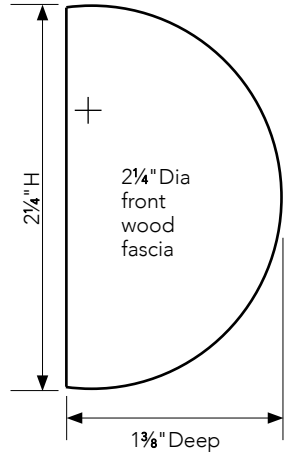
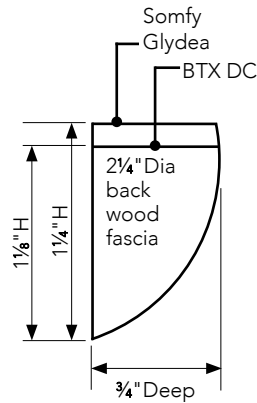
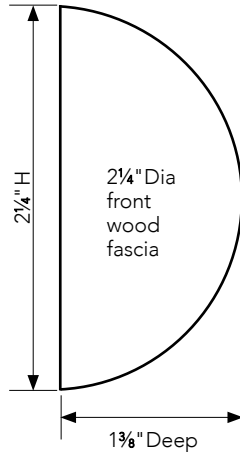
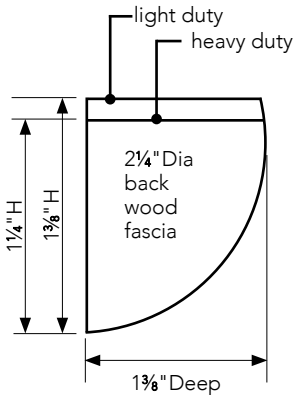

3"

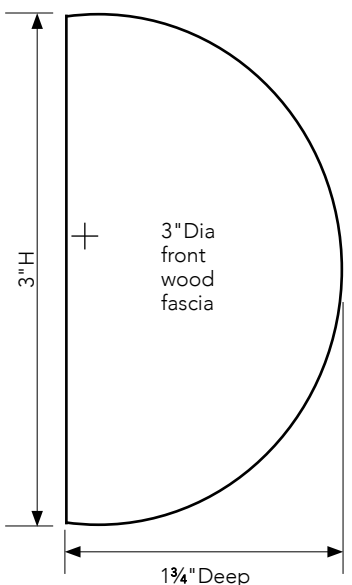
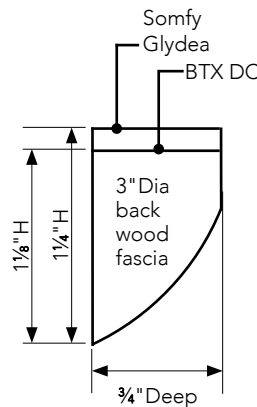
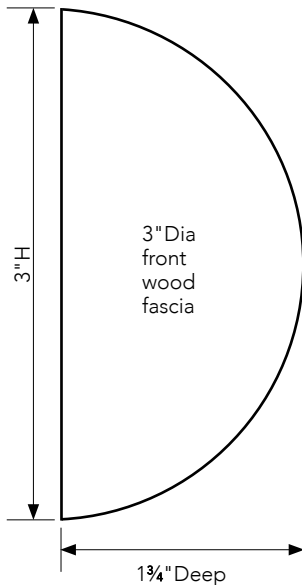
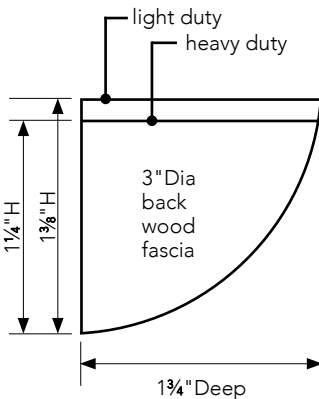



light duty traverse systems

- Recommended for lightweight fabrics & sheers
- Corded or baton draw
- Available in all profiles for 1 $\frac{7}{8}$ ", 2", 2 $\frac{1}{4}$ " and 3" diameters or without a wood fascia
- Available with or without decorative c-rings for 2", 2 $\frac{1}{4}$ " and 3" diameters
- Finials or mitered returns sold separately
- Pinch Pleat
- Center or one-way draw
- Track, brackets and glides in white or bronze
- Continuous track available up to 20'; continuous fascia available up to 16'; splices and blended fascia can be used to achieve longer lengths

light duty traverse

CORDED OR BATON DRAW, PINCH PLEAT ONLY.

Single Traverse System

- coordinates with all fascia profiles or available with no fascia
- standard single brackets are adjustable: 3½" - 4½" return
- 6" return bracket may be substituted at no charge
- custom ceiling mount brackets for systems with fascia available for an additional charge
- batons and finials sold separately
- c-rings available for 2", 2¼" and 3" diameter round fascia systems without mitered returns; sold separately



Double Traverse System

Back track available with or without wood fascia. Back track shown with fascia and end caps.

- coordinates with all fascia profiles or available with no fascia
- standard double brackets are adjustable: 2½" - 3½" back track and 5½" - 6¼" front track return
- custom ceiling mount brackets for systems with fascia available for an additional charge
- batons and finials sold separately
- c-rings available on front track for 2", 2¼" and 3" diameter round fascia systems without mitered returns; sold separately



Single or Double Traverse System with Mitered Returns

Back track available with or without wood fascia. Finials and c-rings are not available with this option.

- coordinates with all fascia profiles
- standard single brackets are adjustable: 3½" - 4½" return
- standard double brackets are adjustable: 2½" - 3½" on back track and 5½" - 6¼" on front track return
- custom ceiling mount brackets for systems with fascia available for an additional charge
- batons sold separately
- mitered returns sold separately



Stationary Front Pole with Back Traverse System

2", 2¼", and 3" wood poles can be used. Shown with custom traverse brackets. Back track available with or without wood fascia. Back track shown with fascia and end caps.

- traverse system coordinates with all 2", 2¼" and 3" round fascia profiles; flat and slim fascia may not be used
- coordinates with 2", 2¼" and 3" poles for stationary front pole
- stationary front pole and TBKT bracket must be ordered separately
- returns need to be specified for front pole and back traversing track
- batons and finials sold separately
- rings are available for front pole and are sold separately



accessories

traverse systems



PINCH PLEAT

BRACKETS AND PINCH PLEAT CARRIERS

quantity per system

	6'	7'	8'	9'	10'	11'	12'	13'	14'	15'	16'
pinch pleat carriers	24	28	32	36	40	44	48	52	56	60	64
brackets	3	3	4	4	4	5	5	5	6	6	6

standard carriers are 4 per foot, standard brackets are 1 every 3-4 feet

COMPONENT COLORS

	White	Bronze	Antique Gold
Track	•	•	•
Brackets	•	•	•
Glides	•	•	



HDTB35-L
steel traverse bracket, single return adjustable 3½" - 4½" 2¾"H x 1½"W backplate



HDTB10-L NEW
steel custom bracket, single or double 4½"H x 1½"W backplate specify return up to 10".



HDTB-L
steel traverse bracket, double, can be used for single 6" return adjustable 5½"-6¼" front return adjustable 2½"-3½" back return 3¾"H x 1½"W backplate



CMBC-L
light duty traverse ceiling mount bracket clip, single ¼"H x 2⅛" Deep, ⅞"W for track-only system without fascia
for double ceiling mount installation, install two individual brackets into ceiling



CMTB-L
steel custom ceiling bracket, single 2¾"H x 1½"W backplate specify drop: contingent upon whether c-rings are used and which fascia or finials are chosen
for double ceiling mount installation, install two individual brackets into ceiling



TBKT214-L
• 3½"H x ¾"W backplate, 7⅞" front return and 3" back track return*
• use to combine 2" or 2¼" full wood pole with single traverse systems
• includes traverse ceiling mount bracket attached onto the bottom of the over-bracket poles sold separately



TBKT300-L
• 3½"H x ¾"W backplate, 8¾" front return and 3" back track return*
• use to combine 3" full wood pole with single traverse systems
• includes traverse ceiling mount bracket attached onto the bottom of the over-bracket poles sold separately



pinch pleat master carriers
• multi-wheel design for smooth movement
• corded or baton draw
• left and right
• white or bronze



light duty pinch pleat glide
• white or bronze



225CR
wood traverse c-ring 2½"ID, 4⅞"OD use with 2" or 2¼"D round wood fascia

3CR
wood traverse c-ring 3⅞"ID, 5"OD use with 3"D round wood fascia

*for custom returns, see page 56



heavy duty traverse systems

- Recommended for heavier fabrics with lining or treatments mounted over 10' from the floor
- Corded or baton draw
- Available in all profiles for 1 $\frac{7}{8}$ ", 2", 2 $\frac{1}{4}$ " and 3" diameters or without a wood fascia
- Finials or mitered returns sold separately
- Pinch Pleat or Ripplefold roller carriers in 60%, 80%, 100% and 120% fullness
- Center or one-way draw
- Track, brackets and glides in white or bronze
- Continuous track available up to 20'; continuous fascia available up to 16'; splices and blended fascia can be used to achieve longer lengths

heavy duty traverse

CORDED OR BATON DRAW, RIPPLEFOLD OR PINCH PLEAT.

Single Traverse System

C-rings are not available with this option.

- coordinates with all fascia profiles or available with no fascia
- standard single brackets are adjustable: 3½" - 4½" return
- 6" return bracket may be substituted at no charge
- custom ceiling mount brackets for systems with fascia available for an additional charge
- batons and finials sold separately



Double Traverse System

Back track available with or without wood fascia. Back track shown with fascia and end caps. C-rings are not available with this option.

- coordinates with all fascia profiles or available with no fascia
- standard double brackets are adjustable: 2½" - 3½" back track and 5½" - 6¼" front track return
- custom ceiling mount brackets for systems with fascia available for an additional charge
- batons and finials sold separately

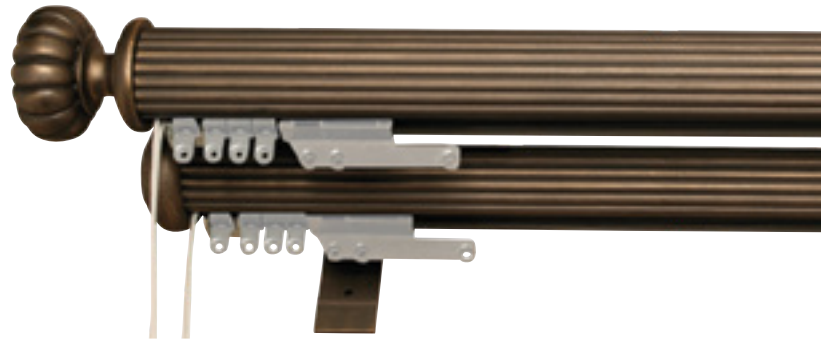

Single or Double Traverse System with Mitered Returns

Back track available with or without wood fascia. Finials and c-rings are not available with this option.

- coordinates with all fascia profiles
- standard single brackets are adjustable: 3½" - 4½" return.
- standard double brackets are adjustable: 2½" - 3½" on back track and 5½" - 6¼" on front track return
- custom ceiling mount brackets for systems with fascia available for an additional charge
- batons sold separately
- mitered returns sold separately



Stationary Front Pole with Back Traverse System

2", 2¼", and 3" wood poles can be used. Shown with custom traverse brackets. Back track available with or without wood fascia. Back track shown with fascia and end caps.

- traverse system coordinates with all 2", 2¼" and 3" round fascia profiles; flat and slim fascia may not be used
- coordinates with 2", 2¼" and 3" poles for stationary front pole
- stationary front pole and TBKT bracket must be ordered separately
- returns need to be specified for front pole and back traversing track
- batons and finials sold separately
- rings are available for front pole and are sold separately



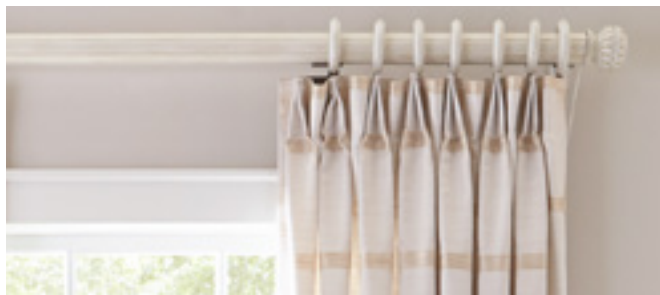

PINCH PLEAT

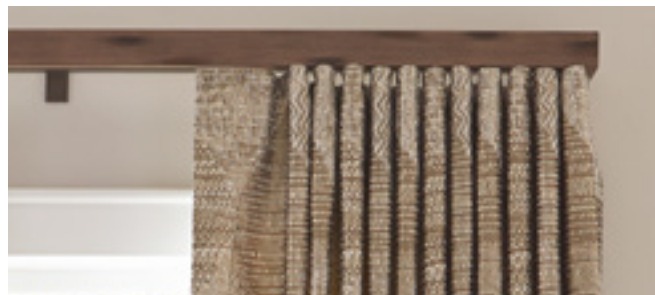

RIPPLEFOLD

available in 60%, 80%, 100% or 120% fullness

BRACKETS AND PINCH PLEAT CARRIERS

quantity per system

	6'	7'	8'	9'	10'	11'	12'	13'	14'	15'	16'
pinch pleat carriers	24	28	32	36	40	44	48	52	56	60	64
brackets	3	3	4	4	4	5	5	5	6	6	6

standard carriers are 4 per foot, standard brackets are 1 every 3-4 feet

COMPONENT COLORS

	White	Bronze	Antique Gold
Track	•	•	•
Brackets	•	•	•
Glides	•		



HDTB35-H

steel traverse bracket, single adjustable 3½" - 4½" return
2¾"H x 1½"W backplate



HDTB10-H NEW

steel custom bracket, single or double 4½"H x 1½"W backplate specify return up to 10".



HDTB-H

steel traverse bracket, double, can be used for single 6" return adjustable 5½"-6¼" front return adjustable 2½"-3½" back return 3¾"H x 1½"W backplate



CMBC-H

heavy duty traverse ceiling mount bracket clip, single ¾"H x 2¾"Deep, 7/8"W for track-only system without fascia

for double ceiling mount installation, install two individual brackets into ceiling



CMTB-H

steel custom ceiling bracket, single 2¾"H x 1½"W backplate

specify drop: contingent upon which fascia or finials are chosen

for double ceiling mount installation, install two individual brackets into ceiling



TBKT214-H

- 3½"H x ¾"W backplate, 7/8" front return and 3" back track return*
 - use to combine 2" or 2¼" full wood pole with single traverse systems
 - includes traverse ceiling mount bracket attached onto the bottom of the over-bracket
- poles sold separately



TBKT300-H

- 3½"H x ¾"W backplate, 8¾" front return and 3" back track return*
 - use to combine 3" full wood pole with single traverse systems
 - includes traverse ceiling mount bracket attached onto the bottom of the over-bracket
- poles sold separately



fascia clip

- use to attach fascia to traverse systems; included

*for custom returns, see page 56



pinch pleat master carriers

- stainless steel overlap arms
- multi-wheel design for smooth movement
- corded or baton draw
- left and right
- available in white



Ripplefold overlap master carriers

- stainless steel overlap arms with snaps to accept Ripplefold tape
- multi-wheel design for smooth movement
- overlap master carriers come standard unless otherwise specified
- corded or baton draw
- left and right
- available in white



Ripplefold butt master carriers

- snaps to accept Ripplefold tape
- multi-wheel design for smooth movement
- butt master carriers do not overlap, allowing some light to filter between draperies on center draw treatments
- butt master carriers must be specified for substitution
- corded or baton draw
- left and right
- available in white



heavy duty ball bearing pinch pleat glide

- ball bearing wheel for smooth movement
- available in white



Ripplefold glide

- Ripplefold glides with detachable pendants
- 60%, 80%, 100% and 120% fullness available *please specify fullness on order*
- available in white



motorized traverse systems

- Recommended for windows where optimal function and light control are desired
- Available in all profiles for 1 $\frac{7}{8}$ ", 2", 2 $\frac{1}{4}$ " and 3" diameters or without a wood fascia
- Available with BTX and Somfy motors
- Finials or mitered returns purchased separately
- Pinch Pleat or Ripplefold roller carriers in 80%, 100% and 120% fullness
- Center or one-way draw
- Track, brackets and glides in white, bronze or antique gold
- Curved track options available on tracks without fascia
- Continuous track available up to 20' with spliced lengths up to 40'
- Continuous fascia available up to 16'; blended fascia can be used to achieve longer lengths

motorized traverse systems

traverse systems

single

double



Single Traverse System with Fascia



Double Traverse System with Fascia



Single Traverse System with Mitered Returns



Double Traverse System with Mitered Returns



Single Traverse System without Fascia



Double Traverse System without Fascia

Somfy® motorized traverse

RIPPLEFOLD OR PINCH PLEAT.

INCLUDED IN SYSTEM: SOMFY® MOTORIZED TRAVERSE TRACK WITH MOTOR AND REMOTE



Somfy motorized track

- track sold in 1 foot increments, 6' minimum
- maximum continuous length is 20'; spliced lengths up to 36'
- includes one motor, standard remote control 5-channel transmitter per track, and fascia with fascia clips when applicable
- available in antique gold, bronze or white; track finish will complement fascia finish
- end drive gears in white only
- may be ordered with or without fascia
- curved tracks available with minimum 11.8" radius; curving fees apply



Somfy Glydea® standard remote control transmitter

(multi-channel hand held remote)

- 5¼"H x 1⅝"W
- 1 remote control per track
- 5 channels
- programmable My Position to set your favorite drapery position
- white

Somfy Glydea® 35e motor

- light duty motor; 1 per track
- maximum drapery weight for light duty motor: 77 lbs
- maximum length for light duty motor: 32'
- 110V Power Supply cord with plug: 120" cord length
- motor can be mounted on left or right for center draw, or top mounted
- return hooks/snaps included; white
- brushed aluminum finish
- 5 year warranty on motor

Somfy Glydea® 60e motor

- heavy duty motor, 1 per track
- maximum drapery weight for heavy duty motor: 132 lbs
- maximum length for heavy duty motor: 36'
- 110V Power Supply cord with plug: 120" cord length
- motor can be mounted on left or right for center draw, or top mounted
- return hooks/snaps included; white
- brushed aluminum finish
- 5 year warranty on motor



HDTB35-S

steel traverse bracket, single adjustable 3½" - 4½" return 2¾"H x 1½"W backplate



HDTB10-S NEW

steel custom bracket, single or double 4½"H x 1½"W backplate specify return up to 10".



HDTB-S

steel traverse bracket, double, can be used for single 6" return adjustable 5½"-6¼" front return adjustable 2½"-3½" back return 3⅝"H x 1½"W backplate



CMBC-S

Somfy single ceiling mount bracket

- ½"H x 2"Deep x 1"W
- available in white
- may only be used in systems without fascia
- single bracket; may be substituted in single or double systems



Somfy fascia clip

• use to attach fascia to traverse systems; included



CMTB-S

steel custom ceiling bracket, single 2¾"H x 1½"W backplate

specify drop: contingent upon which fascia or finials are chosen

for double ceiling mount installation, install two individual brackets into ceiling



TBKT214-S

• 3½"H x ¾"W backplate, 7⅞" front return and 3" back track return*

- use to combine 2" or 2¼" full wood pole with single traverse systems
- includes traverse ceiling mount bracket attached onto the bottom of the over-bracket

poles sold separately



TBKT300-S

• 3½"H x ¾"W backplate, 8¾" front return and 3" back track return*

- use to combine 3" full wood pole with single traverse systems
- includes traverse ceiling mount bracket attached onto the bottom of the over-bracket

poles sold separately

*for custom returns, see page 56

for double ceiling mount installation, install two individual brackets into ceiling



Somfy pinch pleat or Ripplefold master carrier for center or one-way draw

- for use with one-way or center draw
- pinch pleat or Ripplefold
- stainless steel



Somfy Ripplefold butt master carrier for one-way draw

- for use with one-way opening draperies
- Ripplefold only
- stainless steel



Somfy Ripplefold butt master carrier for center draw

- stainless steel arms with snaps to accept Ripplefold tape
- for use with center opening draperies
- butt master carriers do not overlap, allowing some light to filter between draperies on center draw treatments



Somfy standard pinch pleat glide

- ball bearing wheel for smooth movement
- included in system; additional glides may be ordered separately
- available in white



Somfy Ripplefold glide

- snap accepts Ripplefold tape and swivels to create fold
- 80%, 100% and 120% fullness available *specify fullness on order*
- available in white

COMPONENT COLORS

	White	Bronze	Antique Gold
Somfy Track	•	•	•
Somfy Brackets	•	•	•
Somfy Glides	•		

accessories

these additional accessories available for purchase separately



16 channel RTS remote control transmitter with timer and on-screen display - silver
6"H x 2"W
16 channel remote with programmable timer. Available with wall mount clip.

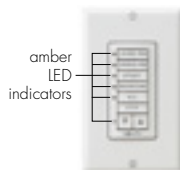

Somfy wireless RTS wall switches - white
4½"H x 2¾"W
open or close the motorized drapery when you enter or exit a room

- battery-powered, wireless switch
- customizable buttons for selecting window treatments throughout the house
- custom button labels available



Somfy indoor sun control
2¾" Dia x ¾"D
uses the intensity of the sun to provide automatic control of window coverings in the home. Mounts on window sill or window glass.



Somfy myLink™

Control your window coverings with a smartphone or tablet

The myLink™ puts you in control, so you can operate your motorized applications whether you're home or away. On vacation and realized you forgot to close your draperies? Not a problem, with a simple tap of a button in the mylink app, you can close all your window treatments at once.

Free app for iOS and Android



Contact us to learn more about additional Somfy accessories.

BTX motorized traverse

RIPPLEFOLD OR PINCH PLEAT.

INCLUDED IN SYSTEM: BTX MOTORIZED TRAVERSE TRACK WITH MOTOR AND REMOTE



BTX motorized track

- track sold in 1 foot increments, 6' minimum
- maximum continuous length is 20'; spliced lengths up to 40'
- includes one motor, BTX transformer, standard remote control 6-channel transmitter per track, and fascia with fascia clips when applicable
- available in antique gold, bronze or white; track finish will complement fascia finish
- may be ordered with or without fascia
- curved tracks available with a minimum 18" radius; curving fees apply

BTX 120 DC motor

- heavy duty motor, 1 per track
- maximum drapery weight for heavy duty motor: 120 lbs
- tandem motors available for increased weight capacity
- maximum length for heavy duty motor: 40'
- 24V transformer with cord with plug: 120" cord length is standard, longer lengths available
- motor can be mounted on left or right for center draw
- white finish



BTX-DC standard transmitter 6 channel, white



BTX transformer only for BTX-DC-120 motors



HDTB35-B
steel traverse bracket, single
adjustable 3½" - 4½"
return
2¾"H x 1½"W backplate



HDTB10-B NEW
steel custom bracket,
single or double
4½"H x 1½"W backplate
specify return up to 10".



HDTB-B
steel traverse bracket,
double, can be used for
single 6" return
adjustable 5½"-6¼" front
return
adjustable 2½"-3½" back
return
3¾"H x 1½"W backplate



CMBC-B
BTX single ceiling mount
bracket
• ½"H x 2"Deep x 1"W
• available in white
• may only be used in
systems without fascia
• single bracket; may be
substituted in single or
double systems

*for double ceiling mount
installation, install two
individual brackets into
ceiling*



BTX fascia clip
• use to attach fascia
to traverse systems;
included



CMTB-B
steel custom ceiling bracket, single
2¾"H x 1½"W backplate

specify drop: contingent upon which fascia or finials are chosen

for double ceiling mount installation, install two individual brackets into ceiling



TBKT214-B

- 3½"H x ¾"W backplate, 7⅞" front return and 3" back track return*
- use to combine 2" or 2¼" full wood pole with single traverse systems
- includes traverse ceiling mount bracket attached onto the bottom of the over-bracket

poles sold separately
**for custom returns, see page 56*



TBKT300-B

- 3½"H x ¾"W backplate, 8¾" front return and 3" back track return*
- use to combine 3" full wood pole with single traverse systems
- includes traverse ceiling mount bracket attached onto the bottom of the over-bracket

poles sold separately



BTX pinch pleat master carrier for center or one-way draw

- stainless steel overlap arms
- multiwheel design for smooth movement
- standard for pinch pleat treatments
- standard right overlap
- available in white, bronze or antique gold



BTX Ripplefold master carrier for one-way draw

- stainless steel snaps to accept Ripplefold tape
- multiwheel design for smooth movement
- standard for Ripplefold style treatments
- standard right overlap
- available in white, bronze or antique gold



BTX Ripplefold master carrier for center draw

- stainless steel snaps to accept Ripplefold tape
- butt master carriers do not overlap allowing some light to filter between draperies on center draw treatments
- butt master carriers must be specified for substitution
- available in white, bronze or antique gold



BTX standard pinch pleat glide

- ball bearing wheel for smooth movement
- included in system; additional glides may be ordered separately
- available in white, bronze or antique gold



BTX Ripplefold glide

- snap accepts Ripplefold tape and swivels to create fold
- 80%, 100% and 120% fullness available
- specify fullness on order
- available in white

COMPONENT COLORS

	White	Bronze	Antique Gold
BTX Track	•	•	•
BTX Brackets	•	•	•
BTX Glides	•	•	•

Ripplefold glides available in white only.

accessories

these additional accessories available for purchase separately



BTX double wall switch
one or two channel



BTX extra cord

- extra cord available up to 20'
- cord from motor to wall is 5'

Contact us to learn more about additional BTX accessories.

traverse systems

how to order the perfect traverse system every time - in 4 easy steps.

1 SELECT YOUR TRAVERSE SYSTEM



single traverse
light duty, heavy duty, motorized



double traverse
light duty, heavy duty, motorized



stationary front pole and traverse back
light duty, heavy duty, motorized



single traverse with fascia & c-rings
light duty only



double traverse with fascia & c-rings
light duty only

2 SELECT A FASCIA DIAMETER AND PROFILE

	1 7/8" Dia	2" Dia	2 1/4" Dia	3" Dia
Slim Round Smooth	•			
Smooth		•	•	•
Grooved		•	•	•
Fluted		•	•	•
Reeded		•	•	•
Wide Reeded			•	
Flat Smooth			•	
No Fascia	•	•	•	•

fascia choice: no fascia flush end mitered returns _____
(specify return. see mitered return charges.)
 or

add finials and select finish: _____
choose finish from list of available finishes to the right or submit a custom finish request.

3 SELECT YOUR DRAPERY STYLE

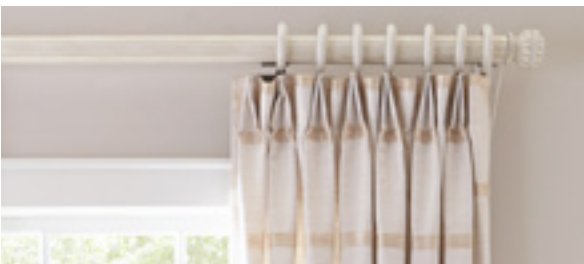

PINCH PLEAT

overlap

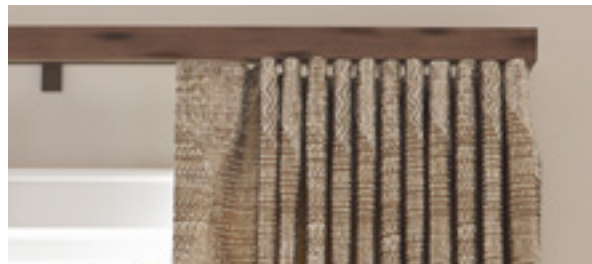

RIPPLEFOLD

overlap butt master

60% 80% 100% 120% fullness

60% fullness not available on Somfy or BTX motorized systems

4 COMPLETE YOUR TRAVERSE SPECIFICATIONS

Mount Type: wall mount ceiling mount

COMPONENT COLORS

	hand-draw		motorized	
	light duty	heavy duty	BTX	Somfy
WHITE	•	•	•	•
BRONZE	•		•	
ANTIQUE GOLD			•	

Drapery Draw:

cord draw add baton: _____
(cord length: 120" standard) (baton sold separately)

cord position:

left
 right

Direction:



center draw one-way left one-way right

Based on your specified finish we supply track and brackets that best match the finish on your fascia. Please refer to the Finish Reference Guide to the right. If you order a custom match finish, please specify your track color.

Components are included in the per foot track price, as listed in the Retail Price List. Components will match the track color when applicable.

Standard carriers are 4 per foot. Standard brackets are 2 end brackets with 1 support bracket for every 3-4 feet of track.

Wood pole profiles available in 1 7/8", 2", 2 1/4" and 3" diameters can be used as fascia.

Spliced fascia will be cut at a 45° angle for an obscure splice upon request.

Spliced fascia can be blended for an additional fee (see Retail Price List). Blended fascia will be properly connected and shipped in one continuous length.

Finish name	Finish code	Recommended track & bracket color
2018 NEW FINISHES		
Charred Toasted Oak	800	Bronze
Bronzed Ore	810	Bronze
Sea Salt Black	820	Bronze
Driftwood	830	White
White with Gold Accents	840	White
Soft Brass	850	Antique Gold
Grayed Brass	860	Bronze
Chalet Gray	870	White
Parchment	880	White
Warm Walnut	890	Bronze
STANDARD FINISHES		
Gilded Red	600	Antique Gold
Cobalt Bronze	610	Bronze
Weathered Iron	620	Bronze
Ash Gray	630	White
Oil Rubbed Bronze	640	Bronze
Hickory	650	Bronze
Antique White	660	White
Espresso	670	Bronze
Aged Gold	680	Antique Gold
Champagne	690	Bronze
Graphite	700	Bronze
Tarnished Silver	710	Bronze
Tawny Oak	720	Antique Gold
Rose Gold	730	Bronze
Smoky Mocha	740	Bronze
Polished Gold	750	Antique Gold
Rustic Iron	760	Antique Gold
Bronze Patina	770	Bronze
Hazelwood	780	Bronze
Vintage Bronze	790	Bronze
Bronze	105	Bronze
Bronze with Gold	106	Bronze
Bronze with Gold and Gray	107	Bronze
Flat Black	109	Bronze
Flat Black with Gold	110	Bronze
Silver with Gold	112	Antique Gold
Walnut Gold	117	Antique Gold
Dark Walnut Gloss with Gold	126	Bronze
Antique Steel	129	Bronze
Antique Steel with Black Highlights	129B	Bronze
Gray with Gold	150	Antique Gold
Antique	155	Antique Gold
Walnut Gold with Gray Accents	200	Antique Gold
Walnut	240	Bronze
Platinum	250	Bronze
Platinum with Black Highlights	250B	Bronze
Mahogany Rust	270	Bronze
Pewter	320	Bronze
Bronze with Black	330	Bronze
Statuary Bronze with Gold	350G	Bronze

display boards



TFC18WRDB1 NEW
 wood & resin
 display board 1
 42"H x 24"W x 7"Deep
 wall mount

TFC18WRDB1RETRO NEW
 wood & resin retro kit 1
 wall mount



TFC18WRDB2 NEW
 wood & resin
 display board 2
 42"H x 24"W x 7"Deep
 wall mount

TFC18WRDB2RETRO NEW
 wood & resin retro kit 2
 wall mount

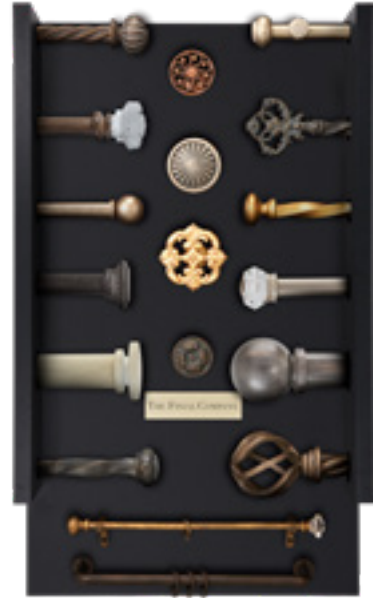

TFC18SDB NEW
 steel display board
 42"H x 24"W x 7"Deep
 wall mount

TFC18SDBRETRO NEW
 steel retro kit
 wall mount



TFC18TTMETAL NEW
 metal table top display
 12¼"H x 20"W x 8"Deep



TFC18TTMODMETAL NEW
 modern metal table top display
 12¼"H x 20"W x 8"Deep

how to measure

1. Measure the window width from outside the casing edges. We recommend at least 2" to 4" per side for bracket placement, or finding wall studs on each side of the window in which to drill. Installing the brackets into wall studs is the safest and most secure installation method. Refer to window illustration below.
2. If a window is in the corner, make sure there is enough room to accommodate the finial.
3. The height of the bracket position is determined by the finished drapery length and style. If the treatment is designed to be used with rings, be sure there is proper allowance for the drop of the ring. Refer to the ring illustration below.

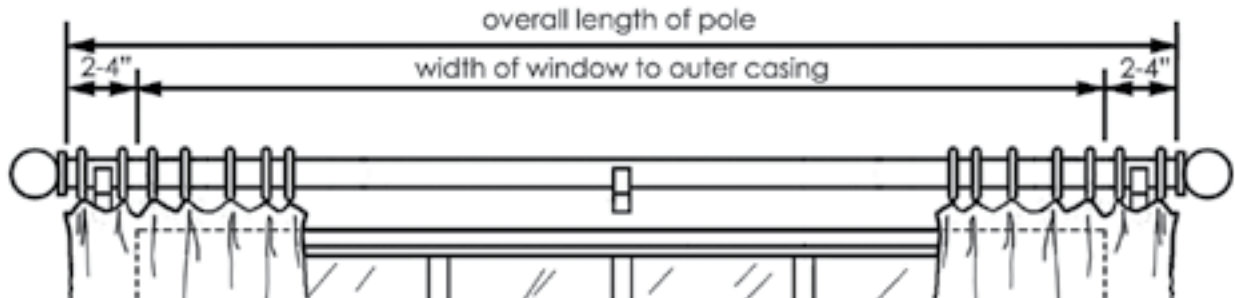

Before you can choose which bracket, ring, and pole diameter to order, you must determine how much room you will have above and to the sides of your window. Some brackets have tall backplates that may either look too large or may not fit into tight spaces.

Things to consider:

1. Does the bracket backplate fit between the top of your window and the ceiling?
2. At what height do you need the pole to be positioned? Will this bracket accommodate your window installation design?
3. If you plan to use rings, what height does the top of your drapery panel need to reach? Will your choice of bracket, ring, and pole diameter accommodate your window treatment design?

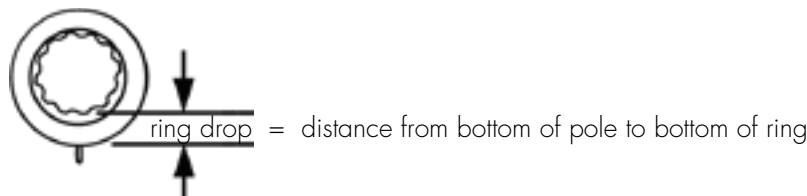

The ring drop determines the height at which the top of the drapery panel will be installed, if using rings. If not using rings, the pole should be installed at a height suitable for a drapery rod pocket or other type of drapery treatment.

We recommend using a professional installer to measure and install your drapery hardware treatments whenever possible.

How to measure:

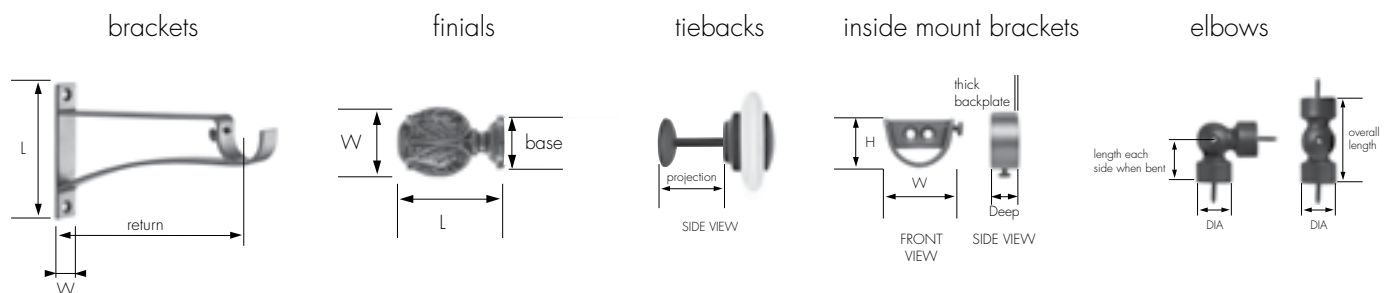

terms & conditions

PRICING AND TERMS

Prices found in The Finial Company Retail Price List are our suggested retail prices. Prices are subject to change without notice. Prices are quoted exclusive of freight and packaging. The buyer should always inspect the product upon receipt.

IMPORTANT: Please note that your order will be placed with an authorized Finial Company Distributor. While most of the following will generally apply, your distributor may have terms and conditions of sales that will vary from what is stated here.

Estimated Lead Times: Purchase orders are processed once they are received by The Finial Company. Incomplete information will delay processing and shipping. The Modern Metal and Metal Collection will ship within 48 hours of the order confirmation. Painted product (including painted products from the Metal Collection), custom products and traverse systems will ship within 10-15 business days of the order confirmation.

Rush Orders: Rush orders are available. An additional 30% charge applies to product and all fees excluding freight and packaging. Rush orders will ship within 5 business days. The 30% rush charge is available for all product except arch rods, bay windows, custom brackets, and mitered returns. If an order is received after 12:00 C.S.T., the next business day will count as the first day of production.

IMPORTANT: Please note that rush orders are not always available due to the nature of scheduling in a strictly custom manufacturing environment. Processing time for a rush order is in business days, (excluding holidays) not calendar days.

Shipping (NET Fees): Poles or tracks over 96" must be shipped by common carrier. For current common carrier freight rates go to www.thefinialcompany.com/freightrate. Expedited shipments are not available in all areas. Any additional charges for expedited shipments will be in addition to the published net fees.

The following orders will be subject to actual freight costs:

- shipments going to Alaska, Hawaii, Idaho, Montana, Puerto Rico or any international destination.
- orders with poles or tracks exceeding 96" in length
- orders that exceed a \$2,500 SRP

Packaging Fees (NET Fees): A net packaging fee of \$10.00 per order will apply to any order that has a pole. A net packaging fee of \$10.00 will apply to any order with a traverse rod less than 16 feet. The net packaging fee increases to \$25.00 for all orders with arched rods; bay windows; rods with returns; motorized traverse track; or poles, rods and corded traversing track 16 feet or longer.

RETURNS, CHANGES & CANCELLATIONS

All orders are considered "custom". No changes or cancellations will be accepted later than 24 hours after order is confirmed. All returns must be authorized by The Finial Company customer service department, and are authorized at our discretion, given the circumstances and nature of each custom order.

DAMAGED GOODS

Immediately upon receipt, your order should be inspected to ensure that there is no concealed damage from shipping. Claims on damaged merchandise must be made within 15 days of receipt. No claims after 15 days will be accepted. If your order is damaged in shipping, carriers require that all packing materials be kept in order for a representative to inspect the goods. Our policy is that we replace damaged product per the original order.

Please note on the bill of lading if there is any possibility of concealed damaged. If shipping through a 3rd party, distributor is responsible for claiming damages and the remakes will be at charge.

PRODUCT INFORMATION

Wood Poles: Wood poles are sold in 2 foot increments, 2 foot minimum. We will cut your pole to specification, but we do not save or ship the fall off.

Steel Poles: All steel poles are sold in 1 foot increments, 2 foot minimum. We will cut to your specification, but we do not save or ship the fall off.

Metal & Acrylic Poles: All metal and acrylic poles are sold in 2 foot increments, 2 foot minimum. We will cut to your specification, but we do not save or ship the fall off.

Corded or Baton Draw Traverse Tracks: Corded or baton draw traverse tracks are sold in 2 foot increments with a 4 foot minimum. We will cut to your specification, but we do not save or ship the fall off.

Motorized Traverse Tracks: Motorized traverse tracks are sold in 1 foot increments with a 6 foot minimum. We will cut to your specification, but we do not save or ship the fall off.

Support Brackets: We recommend support brackets every 3-4 feet.

Installation: Mollie bolts and nail anchors are recommended for all installations, but are not included. We strongly recommend using a professional installer for our hardware.

Force Majeure: The Finial Company is not liable for any performance failure that arises from any cause not within its control.

ITEM	PAGE	ITEM	PAGE	ITEM	PAGE
1SQ	31, 50, 53	225MC11	74	CR-SR7	37, 53
2EC	76	225MC13	75	CR-SR12	43, 53
2WG	79	225WB1	77	CR-SR75	23, 53
2VWR	79	225WB2	77	CS1756	42
3CR	97	225WCS1	77	CS17535	42
3CSB1	85	225WCS2	77	CSB1	77
3CSB2	85	225WG	79	CSB2	77
3EB4	85	225WR	79	CSL16	36
3EC	82	225WS	79	CSL125	36
3GR	87	225WWR	79	CSL135	36
3L1	85	387	64	CSWB1	78
3L2	85	1340HB	41	CSWB2	78
3L3	85	4519C	27, 34, 47	DB76	76
3L5	85	A1756	42, 51, 65	DB77	85
3L6	85	A17535	42, 51, 65	DB78	76
3-LELB	85	ABTN-36	9, 13, 17, 24, 31, 38, 44, 67, 80, 87	DB79	85
3LFB1	85			DB80	76
3LFB2	85	ABTN-48	9, 13, 17, 24, 31, 38, 44, 67, 80, 87	DBL1	23, 30, 37, 43, 56, 66, 78, 86
3MC11	84			DRRG3	79
3R9	83	ARBC	59	DRRG4	86
3R35	84	ARBE	59	EB1	22
3RD	87	B1756	42, 48	EB2	22
3RF10	83	B17535	42, 48	EB3	36, 48
3RF20	84	BIRD	21, 28	EB4	36, 48
3RF86	83	BKT050-1	17, 51	EB5	42, 48
3RY10	83	BKT050-2	17	EB6	42, 48
3SM	87	BKT050-3	17, 51	EB7	78
3V100	84	BKT050-4	17	EB8	78
3VWB1	85	BKT075-100	22, 29, 51	EB24	77
3VWB2	85	BKT112-134	42, 51	EB26	77
14R704	35	BKT118-138	36, 51, 65	EB2254	77
38B	65	BKT200-214	78	EB2256	77
38EB3	65	BL2	92	EC3	40, 57, 89
38EB5	65	BL3	92	EC4	16, 19, 57, 89
38EC	64	BL4	23, 30, 37, 43, 56, 66, 78, 86	EC135	26, 33, 47
38FLR	66	BL6	92	EC214-1	71
38ISM	65	Branch with Leaf	21, 28	EC300-1	82
50SRB	17, 50, 52	BTX	106	EP1	76
75ELB	17, 22	C1	94	EP8	76
75HSRB	24, 48, 50, 52	C2	94	EPBTN-1	67, 80, 87
75RD	24, 50, 52	C3	94	EPBTN-2	67, 80, 87
138EC	64	C4	94	F050-1C	16
225CR	97	C6	94	F050-1S	16
225EC	76	C7	94	F050-2C	16
225FL	79	C8	94	F050-2S	16
225-RWVR	79	CMTB	97, 100, 104, 107	F050-3	16
225MC9	74	CR-SR3	30, 37, 53	F138-1	63

index

ITEM	PAGE	ITEM	PAGE	ITEM	PAGE
F138-2	63	HSR1	37, 48, 66	R8	91
F138-3	63	HSR2	79	R10	91
F138-4C	64	HSR3	86	R11	89
F138-4S	64	HSR175	43, 48	R15	89
F138-5C	63	IM125	36, 48	R-16	47, 89
F138-5S	63	IM175	42, 48	R-17	91
F138-6	64	IMB050-1	17	R18	89
F138-7	63	K657	20, 27, 35	R-21	90
F138-8	63	L16	36, 51	R-22	90
F138-9	62	L26	36, 48	R23	89
F214-1	71	L125	36	R24	90
F214-2	71	L125-SQ	22, 29	R64	90
F214-3	71	L135	36, 51	R65	90
F214-4	71	L135-SQ	22, 29, 51	R73	90
F214-5	72	L235	36, 48	R101	47, 91
F214-6	72	L651	19, 27	R-107	91
F214-7	71	L651FC1	41	R369	83
F214-8	72	L848	21, 27, 47	R22569	74
F214-9	72	L848FC1	41, 47	RD3	84
F214-10	72	L9328	27, 34, 57	RD125	38, 50, 53
F214-11	72	L9328B	27	RD175	44, 50, 53
F214-12	71	L125100	22, 29	RD225	75
F214-13	73	L135100	22, 29, 51	REC73	71, 89
F214-14	72	L885875	20, 27	REP1	89
F214-15C	72	Large Swing Arm with Scroll	57	RF4	33, 89
F214-15S	72	Large Swing Arm without Scroll	57	RF5	62
F214-16C	73	LFB3	76	RF10	74
F214-16S	73	LFB4	76	RF20	75
F300-1	84	LL	57	RF21	75
F300-2	82	LS385	35, 41, 47	RF63	72
F300-3	83	LS385FC1	41	RF64	76
F300-4C	83	MB100	31, 92	RF86	64
F300-4S	83	MB138	67, 92	RF1000	73
F513	84	MB214	80, 92	RMC11	90
FBKT 23, 30, 37, 43, 56, 66, 78, 86		NBL2	47, 92	RMC13	89
FBTN 17, 24, 31, 38, 44, 67, 80, 87		NBL4	47, 92	ROS-1C	90
FC1	40, 58	NBL6	47, 92	ROS-1S	90
Finial Adaptor	58	OVL1	37, 48, 66	ROS-2	90
FSR1	30, 37, 51, 66	OVL2	79	ROS-3	91
FSR2	43, 51	OVL3	37, 66	ROS-4	91
GB1	74	OVL7	43, 79	ROS-5	91
GB2	73	OVL12	79	ROS-6C	90
GB3	75	OVL175	43, 48	ROS-6S	90
GB4	64	PB	21, 28	RR100	31, 48, 52
HDTB	97, 100, 104, 106	PBN	21, 28	RR125	38, 48, 53
HDTB10	97, 100, 104, 106	R-2	90	RR175	44, 48, 53
HDTB35	97, 100, 104, 106	R5	89	R-RND	89

ITEM	PAGE	ITEM	PAGE	ITEM	PAGE
S93	16, 19	SQRG1	23, 30, 51	TFCM118207	8
SBTN	17, 24, 31, 38, 44, 67, 80, 87	SR1	23, 48, 51	TFCM118401	7
SBTN60	17, 24, 31, 38, 44, 67, 80, 87	SR3	30, 37, 48, 51	TFCM118402	7
SCB35	22, 29, 36, 42, 53, 56	SR5	43, 48, 79	TFCM118403	8
SCB6	22, 29, 36, 42, 53, 56	SR7	43, 48, 51, 79	TFCM118420	7
SCBC	22, 29, 36, 42, 53, 56	SR05	17, 51	TFCM118420L	7
SCBCDBL	22, 29, 36, 42, 53, 56	SR11	86	TFCM118424	7
SEC-2	33, 40, 47, 89	SR12	79	TFCM118426	7
SEC-125	19, 26, 33, 47, 89	SR13	66	TFCM118427	7
SELB	42	SRH75	24, 52	TFCM118428	7
SF-1	19, 27	SRT1	31, 52	TFCM118429	7
SF3	19	SRT2	38, 53	TFCM118690	6
SF-4	34, 40	SSA	34	TFCM118800	6
SF19	21, 28, 35	ST2	31, 48, 52	TFCM118801	6
SF35	16	ST3	31, 48, 52	TFCM118802	6
SF36	19	STB	93	TFCM138002	8
SF37	16	STBA1	58, 93	TFCM138004	8
SF45	27, 34	STBA7	93	TFCM138006	8
SF63	34, 40, 47	TBA	58, 93	TFCM138008	8
SF69	19, 26	TBKT	23, 30, 37, 43, 56, 66, 78, 86, 97, 100, 104, 107	TFCM138010	8
SF70	35, 41			TFCM138012	8
SF90	41	TFCM312S	9, 13	TFCM138100	11
SF96	35, 41	TFCM314S	9, 13	TFCM138101	11
SF131	34	TFCM316S	9, 13	TFCM138102	11
SF132	27, 35	TFCM600	4, 5	TFCM138103	11
SF133	19, 27, 34	TFCM600/CL	4, 5	TFCM138104	11
SF135	20, 27	TFCM601	5	TFCM138105	11
SF138	35, 40	TFCM601/CL	5	TFCM138106	11
SF140	40	TFCM602	5	TFCM138107	11
SF150	40	TFCM602/CL	5	TFCM138190	11
SF151	40, 47	TFCM603	5	TFCM138200	12
SF158B7	20, 27, 35	TFCM604	5	TFCM138201	12
SF180	19, 26	TFCM605	5	TFCM138202	13
SF192	40	TFCM606	5	TFCM138204	13
SF201	19, 26	TFCM691	6	TFCM138205	8
SF202A	19, 26	TFCM691/CL	6	TFCM138206	13
SF202B	19, 26	TFCM692	6	TFCM138207	8
SF228	41	TFCM692/CL	6	TFCM138208	13
SF230	26, 34	TFCM990	8	TFCM138210	13
SF236	20, 27	TFCM991	8	TFCM138212	13
SF237	26, 34	TFCM118002	8	TFCM138310	12
SHT1	31, 53	TFCM118004	8	TFCM138400	12
SL	57	TFCM118006	8	TFCM138400L	12
SL3	57	TFCM118008	8	TFCM138401	7, 12
Small Swing Arm	57	TFCM118010	8	TFCM138402	7, 12
SOMFY	104	TFCM118012	8	TFCM138403	8, 13
SQEC	26	TFCM118205	8	TFCM138404	12

index

ITEM	PAGE	ITEM	PAGE	ITEM	PAGE
TFCM138406	12	TFCR214192	69	TFCS214MCMCMBK	77
TFCM138408	12	TFCR214193	69	TRT	44, 53
TFCM138420	7	TFCR214194	69	TTBH-1	48, 93
TFCM138420L	7	TFCR214195	69	TTBH-2	48, 93
TFCM138424	7	TFCR214196	69	W551	76
TFCM138426	7	TFCR214REL	77	WBTN	67, 80, 87
TFCM138427	7	TFCR300121	82	WG38	67
TFCM138428	7	TFCR300124	82	WL1	78
TFCM138429	7	TFCR300130	82	WL2	78
TFCM138690	6	TFCR300131	82	WL4	78
TFCM138800	6	TFCR300190	82	WL5	78
TFCM138801	6	TFCR300192	82	WNF38	67
TFCM138802	6	TFCS034110	16, 19	WR30	89
TFCR100REL	29	TFCS114110	26, 33	WR38	67
TFCR114REL	36	TFCS114111	26, 33	WRG3	86
TFCR138110	63	TFCS114120	26, 33	WS38	67
TFCR138121	62	TFCS114170	26, 33	WTBS2	92
TFCR138124	62	TFCS114171	26, 33	WTBS4	92
TFCR138125	62	TFCS114190	26, 33	WTBS6	92
TFCR138126	63	TFCS134100	40	WW9	74
TFCR138130	62	TFCS134190	40	WW23	75
TFCR138131	62	TFCS214150	70	WW26-1	83
TFCR137164	63	TFCS214151	70	WW34-1	74
TFCR138165	63	TFCS214163	70	WW35	75
TFCR138170	62	TFCS100GRDBK	29	WW47-1	74
TFCR138171	62	TFCS100GRSBK	29	WW51	73
TFCR138172	63	TFCS100LADBK	22, 29	WW60-1	73
TFCR138190	62	TFCS100LAS6BK	22, 29	WW70-1	74
TFCR138191	62	TFCS100LASBK	22, 29	WW75	83
TFCR138192	62	TFCS100MCMCMBK	22, 29	WW77	76
TFCR138REL	65	TFCS100MIBK	22, 29	WW190	64
TFCR200REL	77	TFCS100SCRI	30, 51	WW201	74
TFCR214110	69	TFCS114GRDBK	36, 51	WW203	75
TFCR214121	69	TFCS114GRSBK	36, 51	WW205	73
TFCR214122	69	TFCS114MCMCMBK	36	WW207	73
TFCR214123	70	TFCS114MCRI	37, 51	WW251	75
TFCR214124	70	TFCS138GRDBK	65	WWB1	77
TFCR214125	70	TFCS138GRSBK	65	WWB2	77
TFCR214130	70	TFCS138MCMCMBK	65	WWB3	65
TFCR214131	70	TFCS138MIBK	65	WWF	79
TFCR214163	70	TFCS138WSDBK	65	WWR	79
TFCR214164	70	TFCS138WSS6BK	65	WWRG	79
TFCR214165	70	TFCS138WSSBK	65	Y10	73
TFCR214170	71	TFCS138MCRI	66		
TFCR214171	71	TFCS200MCMCMBK	77		
TFCR214190	69	TFCS200MIBK	77		
TFCR214191	69	TFCS214MIBK	77		

standard finishes



105 Bronze



150 Gray with Gold

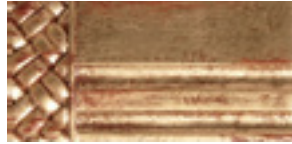

600 Gilded Red

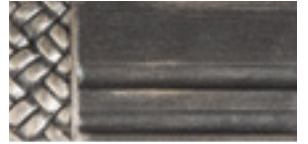

700 Graphite



106 Bronze with Gold



155 Antique



610 Cobalt Bronze

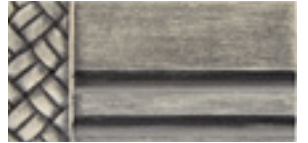

710 Tarnished Silver



107 Bronze with Gold and Gray

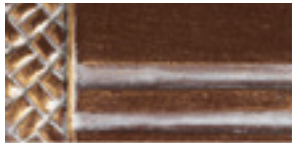

200 Walnut Gold with Gray Accents



620 Weathered Iron



720 Tawny Oak

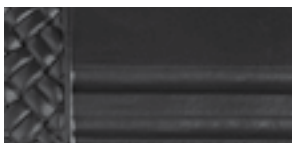

109 Flat Black

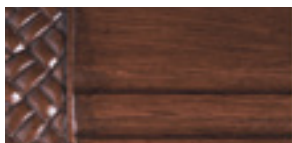

240 Walnut



630 Ash Gray

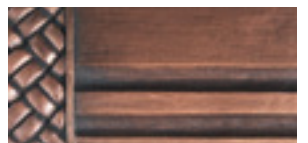

730 Rose Gold

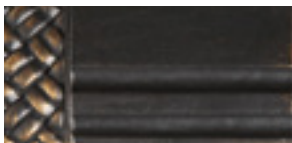

110 Flat Black with Gold



250 Platinum

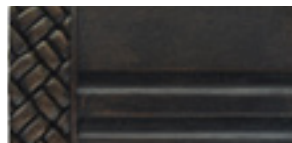

640 Oil Rubbed Bronze



740 Smoky Mocha



112 Silver with Gold



250B Platinum w/Black Highlights

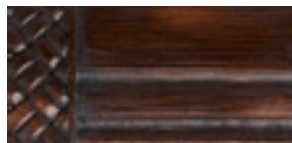

650 Hickory



750 Polished Gold

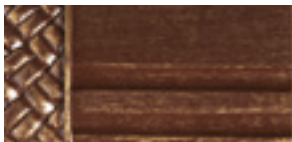

117 Walnut Gold

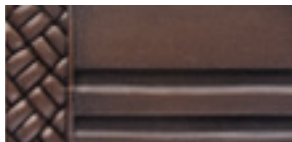

270 Mahogany Rust



660 Antique White



760 Rustic Iron

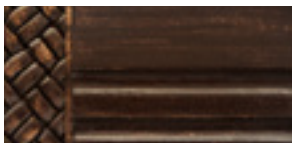

126 Dark Walnut Gloss with Gold



320 Pewter

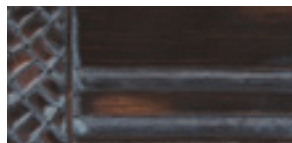

670 Espresso



770 Bronze Patina

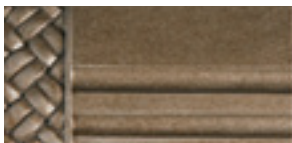

129 Antique Steel

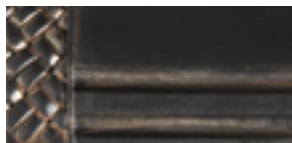

330 Bronze with Black

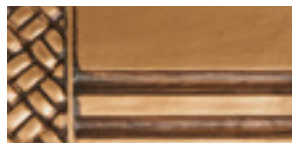

680 Aged Gold

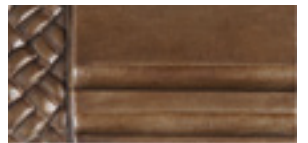

780 Hazelwood



129B Antique Steel w/Black Highlights

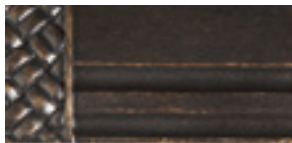

350G Statuary Bronze with Gold

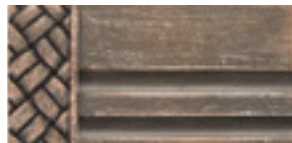

690 Champagne



790 Vintage Bronze

Photographs may not accurately represent the true color of a finish. A finish may show slight variation when painted on different materials, such as wood or steel. For best possible finish match, please refer to the actual sample chip. Please allow 10-15 business days for handpainted finishes. Custom products or finishes may take longer.



800 Charred Toasted Oak



810 Bronzed Ore

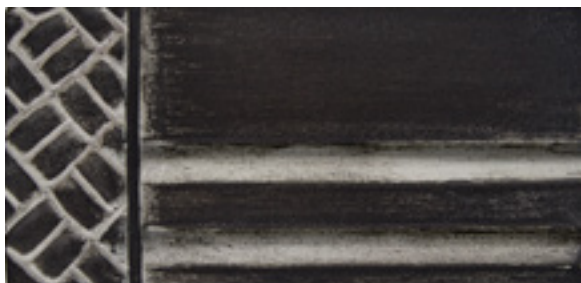

820 Sea Salt Black



830 Driftwood



840 White with Gold Accents

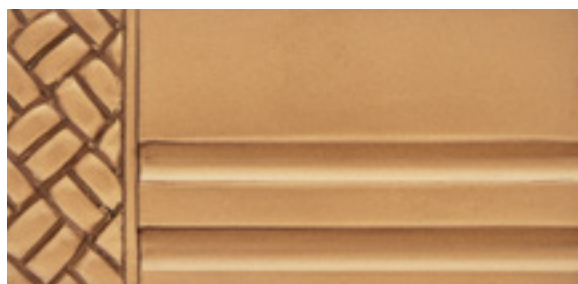

850 Soft Brass



860 Grayed Brass



870 Chalet Gray



880 Parchment

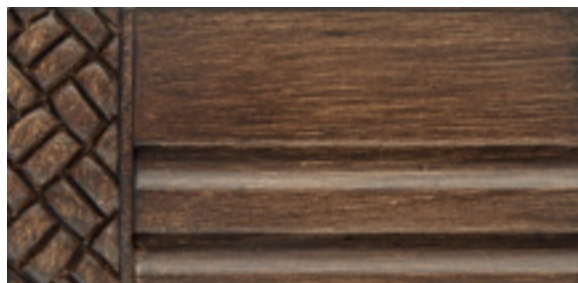

890 Warm Walnut

*Acceptable variations can occur.
Please allow 10-15 business days for production. Custom products or finishes may take longer.*



download the catalog

Contents of The Finial Company catalog and finial styles are fully protected by copyright and must not be reproduced in any manner whatsoever without written permission from The Finial Company. © Copyright September 2018 by The Finial Company. All rights reserved. ® Reg. TM, Rowley Company, LLC. Although we have made every effort to ensure accuracy, actual product color may vary slightly from the catalog depiction. Somfy Glydea is a registered trademark of Somfy Systems, Inc.