

Roller Roman Fabrication

Roller Roman Spools and Shade Clips work with manual or motorized systems. These instructions are for use with manual clutch systems.

1.) CUT MOUNTING BOARD

Cut your wood mounting board to the width of your finished shade. Wrap the board in fabric or paint it if desired.

2.) CUT TUBE

Select the tube size and corresponding clutch and bracket set: Cut your tube a few inches shorter than your wood board.

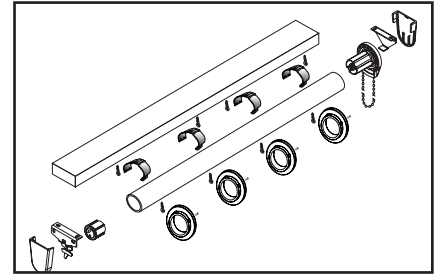
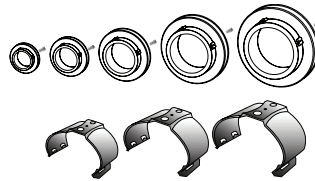

The Roller Roman Spool/Clip is available in up to 5 sizes.

TUBE	RR-SPOOL	RR-CLIP	CLUTCH OPTIONS
1 ¹ / ₄ inch (32mm)	CS3US	RRTC125	(R-Series: R3, R8) (Skyline: SL-10, SL-15)
1 ¹ / ₂ inch (38mm)	CS4US	RRTC15	(R-Series: R-8, R-16, R-24 + Galaxy) (Skyline: SL-10, SL-15, SL-20, SL-30, Skyline Galaxy) (Motorized)
40mm	CS54S	—	Special Motorized Applications
2 inch (50mm)	CS5US	RRTC2	(R-Series: R-16, R-24 + Galaxy) (Skyline: SL-20, SL-30, Skyline Galaxy) (Motorized)
2.5 inch (63mm)	CS6US	—	Galaxy and Motorized

3. INSTALL THE BEAD CHAIN OR CONTROL CORD INTO THE CLUTCH.

Push a loop up from behind the guard. Firmly push the cord clockwise against a tooth edge, until the pulley moves, trapping the cord in the pulley. Use a pencil eraser or your finger to rotate the pulley clockwise, one tooth at a time, all the way around to the other side. A loop will remain in front of the guard. Pull on the cord from behind the guard until the the entire loop falls behind the guard.

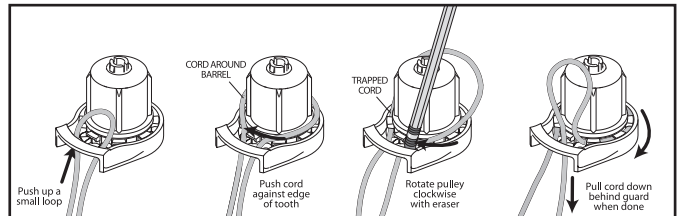

4. INSERT ADAPTERS

The adapters must be inserted into the tube before the clutch and plugs are inserted. Note: 2.5 inch (63mm) tube applications are primarily for motorized applications

5. IF USING PLASTIC BEAD CHAIN, POSITION THE PLASTIC CONNECTOR AS THE UPPER SHADE STOP.

Decide which end of the tube you want to put the clutch in. Keep track of which is the "clutch end" of the tube.

Point the clutch into its end of the tube, and pull on the upper chain until the connector touches the clutch firmly. (Do not attach the lower plastic stop, or any stops on metal bead chain, until installing the shade.)

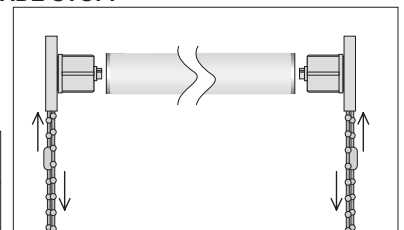
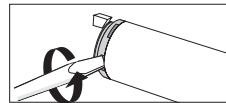

6. INSERT THE CLUTCH AND END PLUG INTO THE TUBE.

IMPORTANT: To remove the clutch or end plug from the tube, gently twist a screwdriver in one or more of the slots between the plastic part and the metal tube.

DO NOT PULL the parts out; you might break them. Only pry them gently.

Roller Roman Fabrication

7. MOUNT THE BRACKETS - INSTALL TUBE (If using Spools, Step S-9 (sliding spools onto tube) should be completed before mounting shade)

R-SERIES

If the clutch is on the right end of the shade, attach the clutch bracket to the right side of the wood board. If the clutch is on the left end of the shade, attach the clutch bracket to the left side of the wood board.

- a. Push the clutch straight onto the blade of its bracket. The bottom of the clutch should always point straight down towards the bottom of the shade.
- b. Lower the lug of the end plug onto the "V" of its bracket. The roller should fit in the brackets securely, with just a little play. Rotate the riveted retainer portion to lock the lug in position. Note: Remember you are building the shade upside down, make sure the lug is positioned so it will be on top of the "V" when the shade is hung in the window.

SKYLINE

Attach the brackets to the mounting board. Brackets are universal so the clutch may be mounted on either side.

- a. Put the spring loaded pin end into the round hole of the bracket.
- b. Keeping the pin end secured in its bracket, insert the hook arms on the clutch straight into the two hook arm receiver slots of the bracket. Once the two hook arms are through the slots, gently pull down on the clutch until the two hook arms have locked securely to the bracket. The bottom of the clutch should always point straight down.

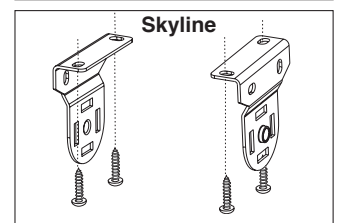
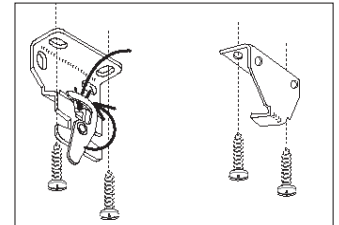

Roller Roman Fabrication

SPOOLS (if using Clips, go on to step C-8)

S-8.) INSTALL SPOOLS

When using spools for your mechanism, it is not recommended to use any screw eyes or to divert the ribbon/cord. Place your RR Spools directly on the tube and secure the spools with the enclosed screw. The spools have no direction, so it will work either with the screw on the right or the left. Due to the nature of the small space needed for the spool, you may place the right and left spool as close as possible to the clutch/pin end as required. Route the ribbon/cord directly from the last top positioned ring on to the spool. This will prevent the shades from going up unevenly. Don't use screw eyes and attach ribbon/cord directly on to the spools as described.

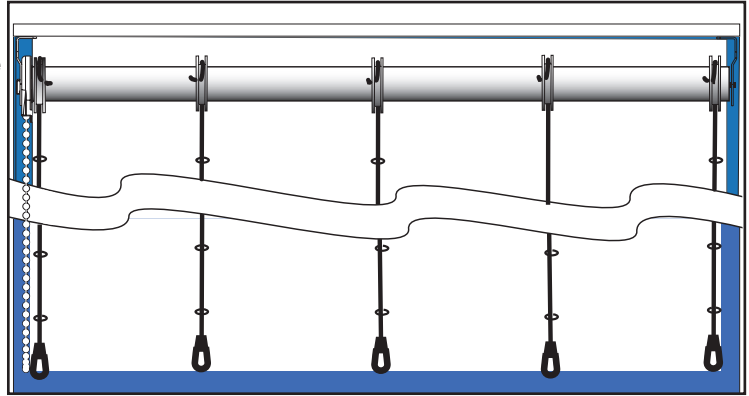

S-9.) ATTACH SPOOLS

Slide one spool onto the tube per lift line. Align each spool directly so each spool is centered left/right over the shade rings. Screw the spool set-screw into the tube ensuring sure each spool is aligned in the same orientation as the other spools.

S-10.) ATTACH RIBBON TAPE or LIFT LINE

The length of the ribbon-tape or lift line must equal the length of the shade plus 6 inches. Direct the ribbon/line from the shade rings up to the spool and through the inside opening of the spool knot hole. On the outside of the spool, tie a double or triple knot that is large enough so it can not pull back through the knot hole.

CLIPS

C-8.) INSTALL SCREW EYES

Install one screw eye for each lift line to the wood mounting board. Mount the screw eyes on the same side of the mounting board as shade fabric. The screw eyes should be in line with the rings on your shade. All lift lines must be routed through a screw eye before attaching to the RR Clip.

C-9.) MARK TUBE

Mark the tube 3 inches to the left or right of the screw eye. (IMPORTANT...Each clip must be equidistant from the screw eye). The clips will be mounted to the left of the screw eye and some to the right of the screw eye. Alternate the position of first clip on the left side and the second clip on the right... alternating left and right across all lift lines. Do not place all the clips on the same side of the screw eye, this may encourage the shade to creep left or right when raised as the lift line spools and the take-up angle changes. When the clips are placed on alternating opposing sides it will neutralize any creeping effect.

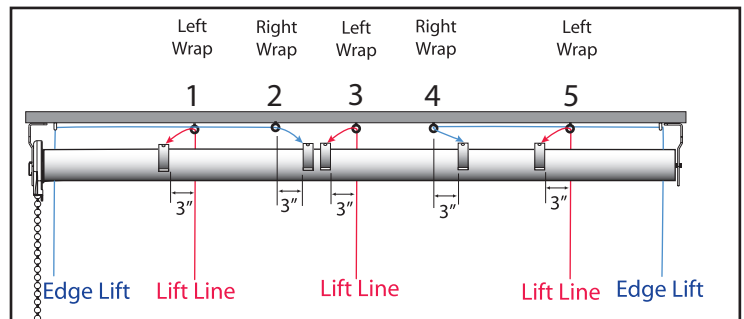

C-10.) ATTACH CLIPS

Based on the tube size selected choose the correct size RR Clip. Once the Clip is attached to the tube it will not slip or pop off of the tube. Note: You may insert a screw driver underneath the clip and lift slightly for small adjustments in positioning. Clips can be attached at this point or it can be pre-corded and then attached.

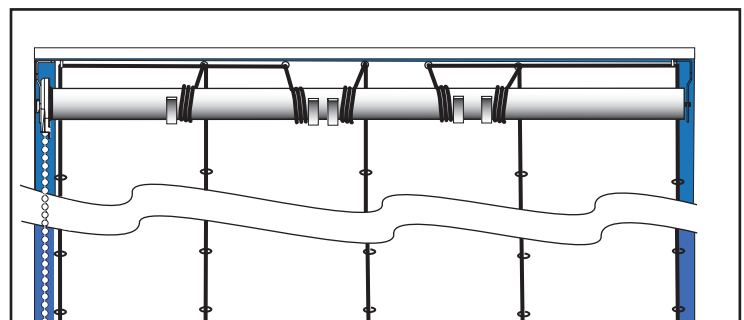

C-11.) ATTACH LIFT LINE

The length of the lift line must equal the length of the shade plus 6 inches. Direct the line from the screw eye to the clip down through the appropriate size opening (depending on cord diameter) Tie with a knot that is large enough so it can not pull through and use a triple knot to secure. There are 2 holes at the top of the clip. The smaller opening accommodates up to 1.4mm cord. The larger opening accommodates up to 2.0mm cord.