

CONTRACT SERIES ONE

Medium Open Roller Shade Clutch Control



The precision engineered Rollease Acmeda Contract Medium Open Roll system is a durable and robust combination of form and function in a sleek package. With a max width of 120" (based on a 120" drop) up to 100 sqf. before linking options. Featuring minimal light gaps, this precision engineered manual chain control is made of Teflon and glass-filled Nylon (Nylon 6), our patented "Velvetrol" technology offers a robust yet smooth operation with comfortable pull forces of less than 6 lbs. Properly balanced precision systems last a lifetime and reduce service calls /issues. Significantly heavier and impressive shading systems require precision engineered, heavy duty hardware, that can support multiples of its own weight.

Features:

- With a max width of 120" (based on a 120" drop) up to 100 sqf. before linking options. Linking options include in-line, angled up to 45° and up to 90° coupling.
- Contract Series One Clutch uses our patented "Velvetrol" configuration to reduce friction, stress and pressure on moving parts allowing for longer life.
- Contract Series One Clutch mechanism disengages to 90% of its holding force allowing for lower pull forces needed to raise larger shading systems.
- Permanently lubricated clutch design made of Teflon and UV stabilized, glass-filled Nylon (Nylon 6) and surgical grade polymers with tempered high carbon steel internal springs will not degrade over time and are impervious to heat and moisture.
- Rollease Acmeda Stainless Steel ball chain is rated to 120 lbs. of pull strength to resist breakage due to standard wear and tear as well as abuse.
- Newly designed Heavy Duty Idler assembly consists of Teflon and glass filled nylon to eliminate noise and resist wear and tear for the life of the shading system.
- Rollease Acmeda chain safety tensioners reach the ANSI/WCMA A100.1-2018 standard and are approved by the Consumer Product Safety Commission to prevent a hazardous loop from being formed to eliminate strangulation hazards.
- Spring assist counter balancing or geared galaxy clutch options for large manual applications
- Accepts standard and reverse roll applications

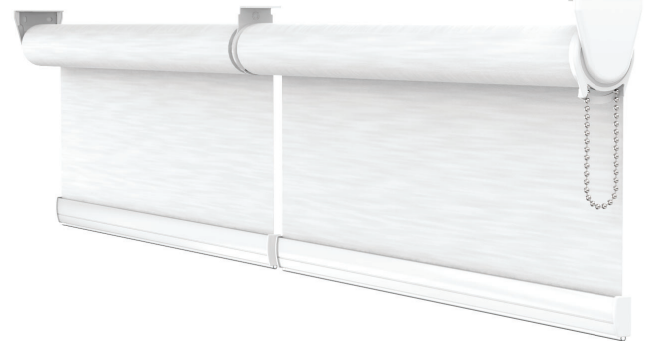

BRACKET COLORS

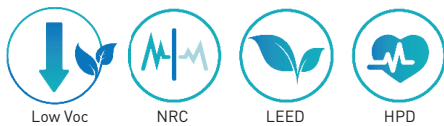
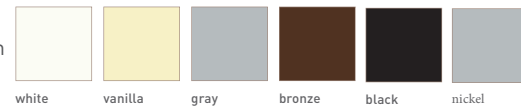

Match this solution with any of our sunscreen, blockout or high performance fabrics for a complete finished solution. See our document library for comprehensive information including HPD, LEED & NRC specifications.

CHILD SAFE OPTIONS

Chainhold

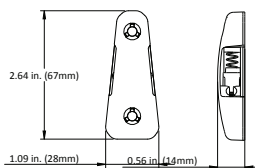
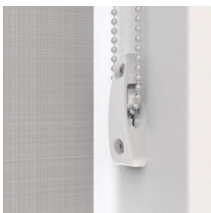

Safety Hold 3

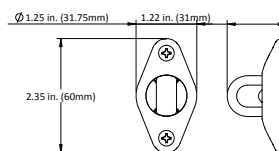

CHAIN OPTIONS

Stainless Steel or NPS

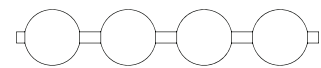

APPROXIMATELY 50-51 BALLS PER FOOT

- NICKLE PLATED STEEL: AVG. TENSILE STRENGTH 50 LBS
- STAINLESS STEEL: AVG. TENSILE STRENGTH 120 LBS

FRONT & SIDE VIEW



Quality Wholesale Window Coverings

Contract • Hospitality • Healthcare • Residential

ph 203-753-1113 customerservice@porterpreston.com www.porterpreston.com

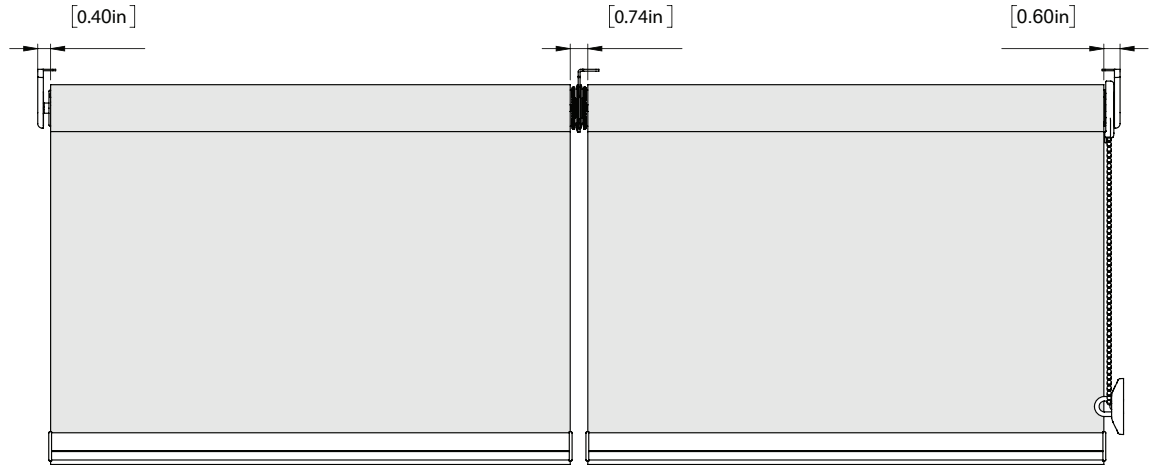
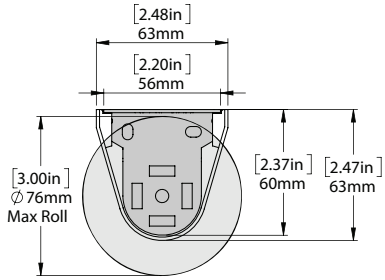

SCHEMATIC

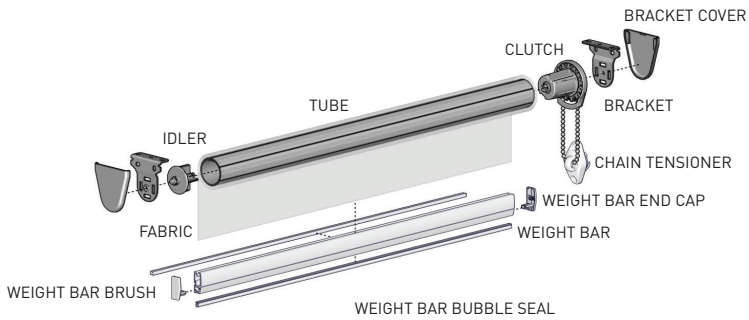

BOTTOM RAIL OPTIONS

D30 SILENT WEIGHT BAR

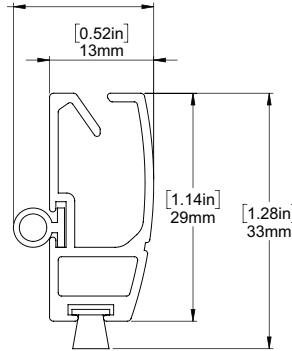

INTERNAL HEM BAR

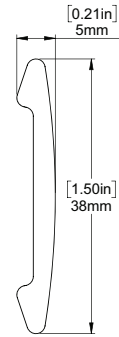

F4115 HEM BAR

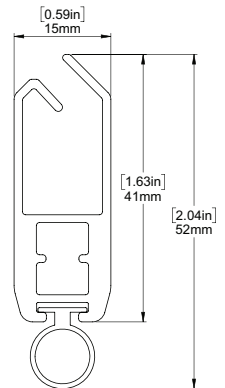

SYSTEM UPGRADES

5" Pocket

[for hidden recess mounts]



L & I Clips

[for hidden recess mounts]

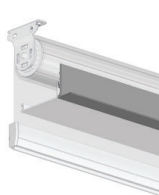

Edge Side Channels

[for improved light blackout]



Internal Wire Guide

[supporting complex shading systems]



Fabric Switch System

[fast easy changing of fabric on a roller shade]

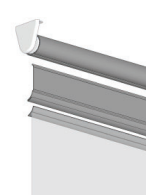

For more information about our Upgrade solutions, see our UPGRADE SPECIFICATION sheets.