



The logo for PORTER PRESTON. It features a large, stylized 'P' on the left, formed by two overlapping, curved shapes in blue and red. To the right of the 'P', the words 'PORTER' and 'PRESTON' are stacked vertically in a bold, blue, serif font.

Quality Wholesale Window Coverings

Contract • Hospitality • Healthcare • Residential

ph 866-753-1113 email customerservice@porterpreston.com www.porterpreston.com



Wood Trends™
2026 Brochure



EXCEPTIONALLY CRAFTED

WOOD TRENDS: A LESSON IN CLASSIC COMPOSURE

Real wood pieces stained or painted in an array of finishes.

Classic forms add a subtle touch of elegance and tradition.

Expertly crafted styles for an updated look on old classics.

We built a solid foundation that is full of classic forms and a strong heritage of quality to bring you our Wood Trends Collection. We brought tradition and character together to create a refined blend of everything you've been dreaming of. Get into your comfort zone with our Wood Trends Collection.





CONTENTS

06	Overview
08	1 $\frac{3}{8}$ " Finials & Components
23	2" Finials & Components
35	Accessories & Components
36	Helpful Guides
36	AMP™ Motorization
38	Estate™ Overview
40	Bracket Spacing & Mount Option
44	Calculating Drapery Weight
45	Stack Guides
52	Pole Installation, Cutting & Splicing
53	Wood Elbow Configuration
54	Complete Collection Overview



COLLECTION OVERVIEW

9

FINISHES

Wood stains and neutral paints

2

VERSATILE SIZES

1 $\frac{3}{8}$ " & 2"

2

ESTATE™ TRAVERSE ROD SIZES

1 $\frac{3}{8}$ " & 2"

1

EXPERTLY CRAFTED COLLECTION

ARCHITRAC™ K-RAIL COMPATIBLE

1 $\frac{3}{8}$ " finials only

AMP™ MOTORIZATION COMPATIBLE

Estate™ Traverse Rods only

- 1 | Marble
- 2 | Coffee
- 3 | Dark Chocolate
- 4 | Truffle

2



1

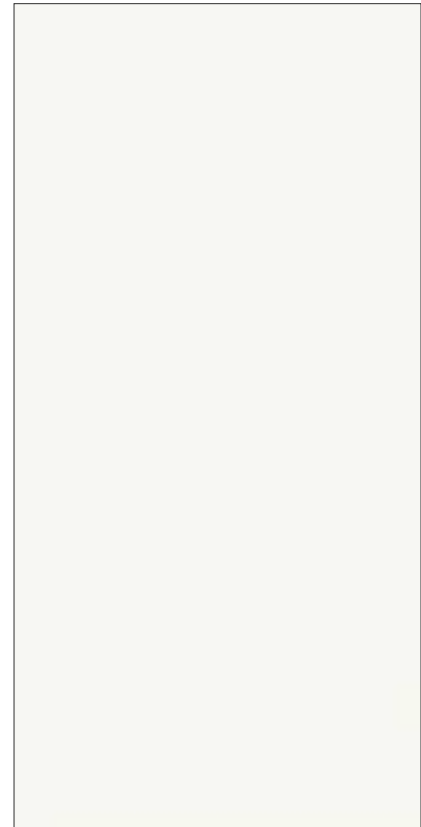

3

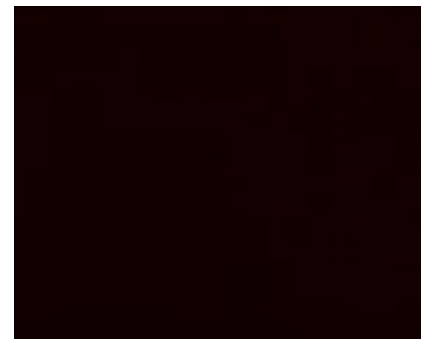

4

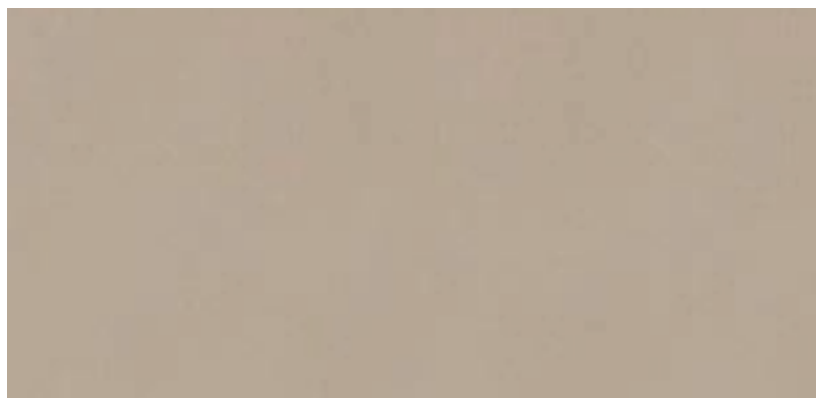

5



6

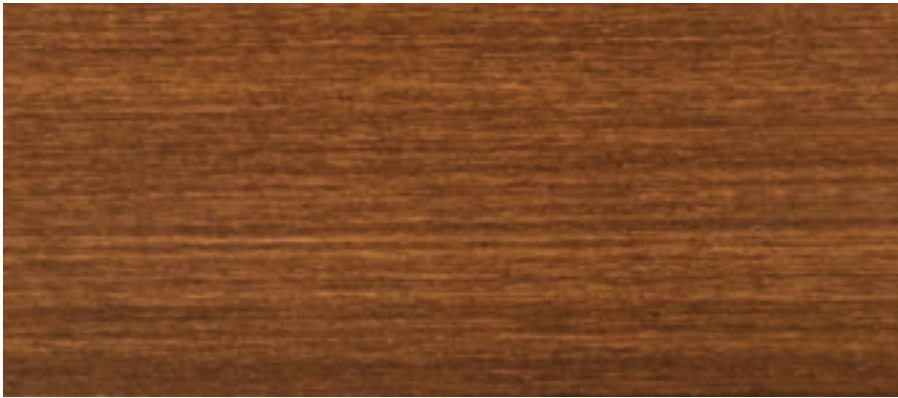

- 5 | Black
- 6 | Estate Oak
- 7 | Unfinished
- 8 | White
- 9 | Mahogany

7



8

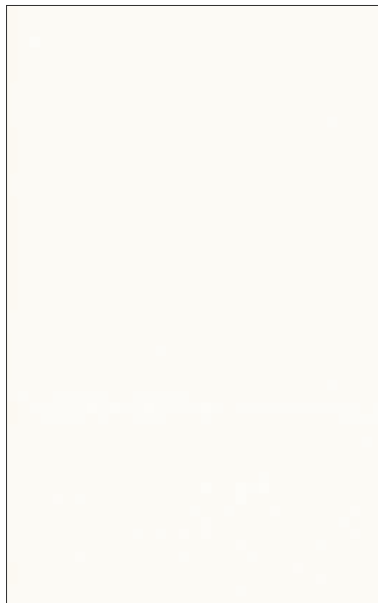

9

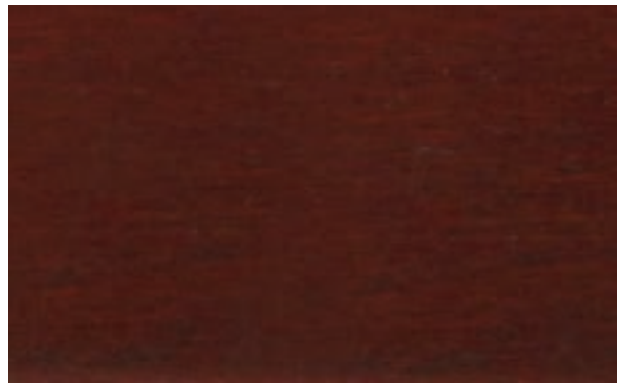

1 3/8" Finials & Endcaps

Button Ball

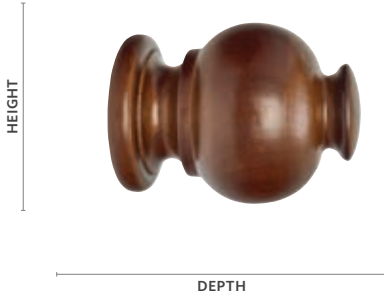

Fits		Dimensions		Quantity per Box	
1 3/8" Wood Trends™ Poles		Depth: 3 1/2"		10 pairs per box	
1 3/8" Estate™ Traverse Rods		Height: 2 1/2"			
1 3/8" K-Rail Traverse Rods		Width: 2 1/2"			
Product Number & Finish					
5629G059	Black	5629G820	Estate Oak	5629G835	Truffle
5629G841	Coffee	5629G083	Mahogany	5629G025	White
5629G825	Dark Chocolate	5629G830	Marble		

Chaucer

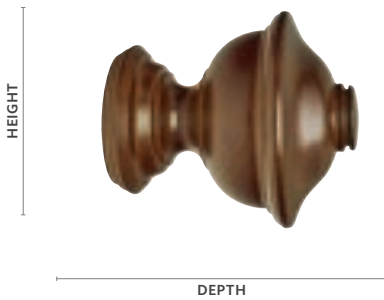

Fits		Dimensions		Quantity per Box	
1 3/8" Wood Trends™ Poles		Depth: 3 3/4"		10 pairs per box	
1 3/8" Estate™ Traverse Rods		Height: 3 1/4"			
1 3/8" K-Rail Traverse Rods		Width: 3 1/4"			
Product Number & Finish					
36807059	Black	36807820	Estate Oak	36807835	Truffle
36807841	Coffee	36807083	Mahogany	36807025	White
36807825	Dark Chocolate	36807830	Marble	36807091	Unfinished

Ethan



Fits		Dimensions		Quantity per Box	
1 3/8" Wood Trends™ Poles		Depth: 2 3/4"		10 pairs per box	
1 3/8" Estate™ Traverse Rods		Height: 3 1/4"			
1 3/8" K-Rail Traverse Rods		Width: 3 1/4"			
Product Number & Finish					
36814059	Black	36814820	Estate Oak	36814835	Truffle
36814841	Coffee	36814083	Mahogany	36814025	White
36814825	Dark Chocolate	36814830	Marble	36814091	Unfinished

Hugo



Fits		Dimensions		Quantity per Box	
1 3/8" Wood Trends™ Poles		Depth: 2"		10 pairs per box	
1 3/8" Estate™ Traverse Rods		Height: 2 1/2"			
1 3/8" K-Rail Traverse Rods		Width: 2 1/2"			
Product Number & Finish					
36815059	Black	36815820	Estate Oak	36815835	Truffle
36815841	Coffee	36815083	Mahogany	36815025	White
36815825	Dark Chocolate	36815830	Marble	36815191	Unfinished

1 3/8" Finials & Endcaps

Miller



Fits	Dimensions	Quantity per Box
1 3/8" Wood Trends™ Poles	Depth: 2 3/8"	10 pairs per box
1 3/8" Estate™ Traverse Rods	Height: 3"	
1 3/8" K-Rail Traverse Rods	Width: 3"	

Product Number & Finish					
36816059	Black	36816820	Estate Oak	36816835	Truffle
36816841	Coffee	36816083	Mahogany	36816025	White
36816825	Dark Chocolate	36816830	Marble	36816091	Unfinished

Sherwood



Fits	Dimensions	Quantity per Box
1 3/8" Wood Trends™ Poles	Depth: 3 3/4"	10 pairs per box
1 3/8" Estate™ Traverse Rods	Height: 2 3/4"	
1 3/8" K-Rail Traverse Rods	Width: 2 3/4"	

Product Number & Finish					
5609EG059	Black	5609EG820	Estate Oak	5609EG835	Truffle
5609EG841	Coffee	5609EG083	Mahogany	5609EG025	White
5609EG825	Dark Chocolate	5609EG830	Marble	5609EG091	Unfinished

Warren



Fits	Dimensions	Quantity per Box
1 3/8" Wood Trends™ Poles	Depth: 1 1/4"	10 pairs per box
1 3/8" Estate™ Traverse Rods	Height: 2 1/2"	
1 3/8" K-Rail Traverse Rods	Width: 2 1/2"	

Product Number & Finish					
36817059	Black	36817820	Estate Oak	36817835	Truffle
36817841	Coffee	36817083	Mahogany	36817025	White
36817825	Dark Chocolate	36817830	Marble	36817091	Unfinished

Wood Ball

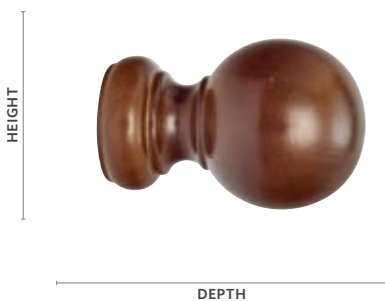

Fits	Dimensions	Quantity per Box
1 3/8" Wood Trends™ Poles	Depth: 3 1/2"	10 pairs per box
1 3/8" Estate™ Traverse Rods	Height: 2 1/2"	
1 3/8" K-Rail Traverse Rods	Width: 2 1/2"	

Product Number & Finish					
5608EG059	Black	5608EG820	Estate Oak	5608EG835	Truffle
5608EG841	Coffee	5608EG083	Mahogany	5608EG025	White
5608EG825	Dark Chocolate	5608EG830	Marble	5608EG091	Unfinished

1 3/8" Finials & Endcaps

Endcap



Fits	Dimensions	Quantity per Box
1 3/8" Wood Trends™ Poles	Depth: 3/4"	10 pairs per box
1 3/8" Estate™ Traverse Rods	Height: 2"	
1 3/8" K-Rail Traverse Rods	Width: 2"	

Product Number & Finish					
36808059	Black	36808820	Estate Oak	36808835	Truffle
36808841	Coffee	36808083	Mahogany	36808025	White
36808825	Dark Chocolate	36808830	Marble	36808091	Unfinished



Hugo | Coffee

1 3/8" Poles

4' Smooth Pole



Diameter	Length	Quantity per Box
1 3/8"	4'	6 pieces per box

Product Number & Finish

56014G059 Black	56014G820 Estate Oak	56014G835 Truffle
56014G841 Coffee	56014G083 Mahogany	56014G025 White
56014G825 Dark Chocolate	56014G830 Marble	56014G091 Unfinished

4' Fluted Pole

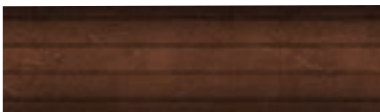

Diameter	Length	Quantity per Box
1 3/8"	4'	6 pieces per box

Product Number & Finish

56004G059 Black	56004G820 Estate Oak	56004G835 Truffle
56004G841 Coffee	56004G083 Mahogany	56004G025 White
56004G825 Dark Chocolate	56004G830 Marble	56004G091 Unfinished

6' Smooth Pole

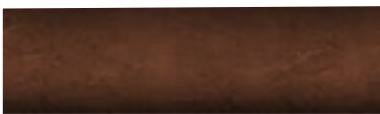

Diameter	Length	Quantity per Box
1 3/8"	6'	6 pieces per box

Product Number & Finish

56016G059 Black	56016G820 Estate Oak	56016G835 Truffle
56016G841 Coffee	56016G083 Mahogany	56016G025 White
56016G825 Dark Chocolate	56016G830 Marble	56016G091 Unfinished

6' Fluted Pole

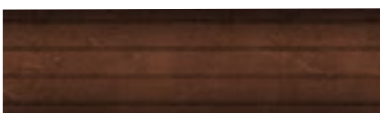

Diameter	Length	Quantity per Box
1 3/8"	6'	6 pieces per box

Product Number & Finish

56006G059 Black	56006G820 Estate Oak	56006G835 Truffle
56006G841 Coffee	56006G083 Mahogany	56006G025 White
56006G825 Dark Chocolate	56006G830 Marble	56006G091 Unfinished

1 3/8" Poles

8' Smooth Pole



Diameter	Length	Quantity per Box
1 3/8"	8'	6 pieces per box

Product Number & Finish

56018G059 Black	56018G820 Estate Oak	56018G835 Truffle
56018G841 Coffee	56018G083 Mahogany	56018G025 White
56018G825 Dark Chocolate	56018G830 Marble	56018G091 Unfinished

8' Fluted Pole



Diameter	Length	Quantity per Box
1 3/8"	8'	6 pieces per box

Product Number & Finish

56008G059 Black	56008G820 Estate Oak	56008G835 Truffle
56008G841 Coffee	56008G083 Mahogany	56008G025 White
56008G825 Dark Chocolate	56008G830 Marble	56008G091 Unfinished

12' Smooth Pole



Diameter	Length	Quantity per Box
1 3/8"	12'	6 pieces per box

Product Number & Finish

560112G059 Black	560112G820 Estate Oak	560112G835 Truffle
560112G841 Coffee	560112G083 Mahogany	560112G025 White
560112G825 Dark Chocolate	560112G830 Marble	560112G091 Unfinished

12' Fluted Pole

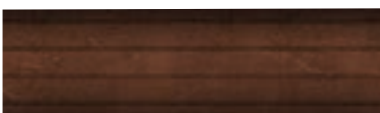

Diameter	Length	Quantity per Box
1 3/8"	12'	6 pieces per box

Product Number & Finish

560012G059 Black	560012G820 Estate Oak	560012G835 Truffle
560012G841 Coffee	560012G083 Mahogany	560012G025 White
560012G825 Dark Chocolate	560012G830 Marble	560012G091 Unfinished

1 3/8" Estate™ Traverse Rods

To learn more about the technical specs on Estate Traverse Rods and AMP™ Motorization, see pages 36-39.

Assembled Set with Slides



Manual Traversing Rods with Selected Carriers					
Unit of Measure					
Foot					
AMP™ Motorization Upcharge					
Charger, item #62201300 included. Remotes sold separately.					
Product Number & Finish					
94675059	Black	94675820	Estate Oak	94675835	Truffle
94675841	Coffee	94675083	Mahogany	94675025	White
94675825	Dark Chocolate	94675830	Marble		

Assembled Set with Wheeled Ripplefold™ Carriers



Manual Traversing Rods with Selected Carriers					
Unit of Measure					
Foot					
AMP™ Motorization Upcharge					
Charger, item #62201300 included. Remotes sold separately.					
Product Number & Finish					
94676058	Black	94676820	Estate Oak	94676835	Truffle
94676841	Coffee	94676083	Mahogany	94676025	White
94676825	Dark Chocolate	94676830	Marble		

Double Bracket

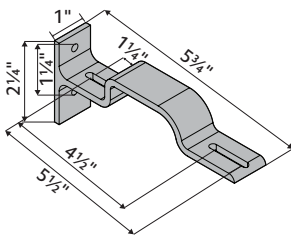

Fits	Dimensions	Quantity per Box
1 3/8" Estate™ Traverse Rods 2" Estate™ Traverse Rods	Depth: 5 3/4" Height: 2 1/4" Width: 1"	10 pieces per box
Product Number & Finish		
71134110	Satin Brass	

Double Bracket

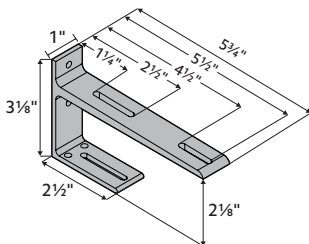

Fits	Dimensions	Quantity per Box	
1 3/8" Estate™ Traverse Rods 2" Estate™ Traverse Rods	Depth: 5 3/4" Height: 3 1/8" Width: 1"	10 pieces per box	
Product Number & Finish			
71132062	Antique Brass	71132110	Satin Brass
71132006	Black	71132012	Satin Nickel













Miller | Mahogany

1 3/8" Estate™ Traverse Rod Components

To learn more about the technical specs on Estate Traverse Rods and AMP™ Motorization, see pages 36-39.

Item	Product No. & Finish	Description	Quantity Per Box
	62101000 White 62101010 Black	AMP Remote Control RF 2W 15 Channel	1 piece per box
	62201300 White	AMP Battery Charger 16.5V/0.89A	1 piece per box
	62102000 White	AMP Gateway USB Bridge	1 piece per box
	62109000 White	AMP Wall Switch Surface RF 2W 15 Channel	1 piece per box
	62108000 White	AMP Wall Switch RF 2W 15 Channel	1 piece per box
	1026660	15" Cable Assembly	10 pieces per box
	1026661	4' Cable Assembly	10 pieces per box
	1026662	10' Cable Assembly	10 pieces per box
	1026663	20' Cable Assembly	10 pieces per box

1 3/8" Rings

Ring with Eyelet



Fits	Dimensions	Quantity per Box
1 3/8" Wood Trends™ Poles	Internal: 1 7/8" External: 2 7/8" External to eyelet: 3 1/4"	10 bags per box - 7 rings per bag

Product Number & Finish		
5602EG059 Black	5602EG820 Estate Oak	5602EG835 Truffle
5602EG481 Coffee	5602EG083 Mahogany	5602EG025 White
5602EG825 Dark Chocolate	5602EG830 Marble	5602EG091 Unfinished

BULK - Ring with Eyelet



Fits	Dimensions	Quantity per Box
1 3/8" Wood Trends™ Poles	Internal: 1 7/8" External: 2 7/8" External to eyelet: 3 1/4"	70 pieces per box

Product Number & Finish		
5602BB059 Black	5602BB820 Estate Oak	5602BB835 Truffle
5602BB841 Coffee	5602BB083 Mahogany	5602BB025 White
5602BB825 Dark Chocolate	5602BB830 Marble	5602BB091 Unfinished

Metal clip, item 5605BB063 can be ordered separately.

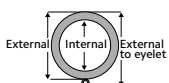

Use the measurement guide to the left to help determine the correct dimensions for your selected product.

1 3/8" Brackets

3 1/2" Return Wood Bracket



Fits	Dimensions	Quantity per Box
1 3/8" Wood Trends™ Poles	Depth: 5 1/4" Height: 3 3/4" Width: 7/8" Wall to Pole: 3" Return: 3 1/2"	10 pieces per box
Product Number & Finish		
5611EG059 Black	5611EG820 Estate Oak	5611EG835 Truffle
5611EG841 Coffee	5611EG083 Mahogany	5611EG025 White
5611EG825 Dark Chocolate	5611EG830 Marble	5611EG091 Unfinished

BULK - 3 1/2" Return Wood Bracket



Fits	Dimensions	Quantity per Box
1 3/8" Wood Trends™ Poles	Depth: 5 1/4" Height: 3 3/4" Width: 7/8" Wall to Pole: 3" Return: 3 1/2"	20 pieces per box
Product Number & Finish		
5611BB059 Black	5611BB820 Estate Oak	5611BB835 Truffle
5611BB841 Coffee	5611BB083 Mahogany	5611BB025 White
5611BB825 Dark Chocolate	5611BB830 Marble	5611BB091 Unfinished

4 1/4" Return Wood Bracket



Fits	Dimensions	Quantity per Box
1 3/8" Wood Trends™ Poles	Depth: 5 1/2" Height: 2 5/8" Width: 1" Wall to Pole: 3 1/2" Return: 4 1/4"	10 pieces per box
Product Number & Finish		
5691G059 Black	5691G820 Estate Oak	5691G835 Truffle
5691G841 Coffee	5691G083 Mahogany	5691G025 White
5691G825 Dark Chocolate	5691G830 Marble	5691G091 Unfinished

6" Return Wood Bracket



Fits	Dimensions	Quantity per Box
1 3/8" Wood Trends™ Poles	Depth: 7 5/8" Height: 4" Width: 7/8" Wall to Pole: 5 1/4" Return: 6"	5 pairs per box
Product Number & Finish		
5614EG059 Black	5614EG820 Estate Oak	5614EG835 Truffle
5614EG841 Coffee	5614EG083 Mahogany	5614EG025 White
5614EG825 Dark Chocolate	5614EG830 Marble	5614EG091 Unfinished



1 3/8" Brackets

Ceiling Mount Bracket



Fits	Dimensions	Quantity per Box
1 3/8" Wood Trends™ Poles	Depth: 5" Height: 4 3/4" Width: 1" Ceiling to Pole: 4" Back Edge to Pole: 2 7/8"	5 pieces per box

Product Number & Finish

46855059 Black	46855820 Estate Oak	46855835 Truffle
46855841 Coffee	46855083 Mahogany	46855025 White
46855825 Dark Chocolate	46855830 Marble	

Double Bracket



Fits	Dimensions	Quantity per Box
1 3/8" Wood Trends™ Poles	Depth: 8" Height: 4 3/4" Width: 1" Wall to Back Pole: 2" Inner Return: 2 3/4" Outer Return: 6"	5 pieces per box

Product Number & Finish

5620EG059 Black	5620EG820 Estate Oak	5620EG835 Truffle
5620EG841 Coffee	5620EG083 Mahogany	5620EG025 White
5620EG825 Dark Chocolate	5620EG830 Marble	



Use the measurement guide to the left to help determine the correct dimensions for your selected product.

1 3/8" Components

Inside Mount Socket



Fits	Dimensions	Quantity per Box
1 3/8" Wood Trends™ Poles	Depth: 1 9/32" Height: 1 13/16" Width: 1 13/16"	10 pairs per box

Product Number & Finish

5605EG059 Black	5605EG820 Estate Oak	5605EG835 Truffle
5605EG841 Coffee	5605EG083 Mahogany	5605EG025 White
5605EG825 Dark Chocolate	5605EG830 Marble	5605EG091 Unfinished

Swivel Socket



Fits	Dimensions	Quantity per Box
1 3/8" Wood Trends™ Poles	Length to Center: 2 3/8" Pole Diameter: 1 3/8" Full Length: 3 3/16" Depth of Socket: 1 1/8"	5 pieces per box

Product Number & Finish

5606E059 Black	5606E820 Estate Oak	5606E835 Truffle
5606E841 Coffee	5606E083 Mahogany	5606E835 White
5606E825 Dark Chocolate	5606E830 Marble	5606E091 Unfinished

Elbow - 3 1/2" - 5 1/2" Clearance



See page 53 for configuration

Fits	Clearance	Quantity per Box
1 3/8" Wood Trends™ Poles	3 1/2" - 5 1/2"	10 pieces per box

Product Number & Finish

5613E091 Unfinished

Elbow - 6" - 8" Clearance



See page 53 for configuration

Fits	Clearance	Quantity per Box
1 3/8" Wood Trends™ Poles	6" - 8"	10 pieces per box

Product Number & Finish

5617091 Unfinished

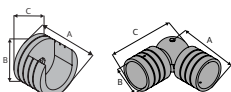

Use the measurement guide to the left to help determine the correct dimensions for your selected product.

1 3/8" Components

Metal Bracket

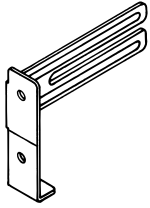

See page 53 for configuration

Fits	Quantity per Box
For use on wood elbows	20 pairs per box
Product Number & Finish	
5623063 Brass	

Hidden Metal Support - 2 1/2" - 3 1/2" Clearance



See page 53 for configuration

Clearance	Quantity per Box
2 1/2" - 3 1/2"	20 pieces per box
Product Number & Finish	
5618063 Brass	

Hidden Metal Support - 4" - 5 1/2" Clearance

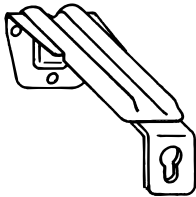

See page 53 for configuration

Clearance	Quantity per Box
4" - 5 1/2"	20 pieces per bag
Product Number & Finish	
5619063 Brass	



Ethan | Black

2" Finials & Endcaps

Button Ball

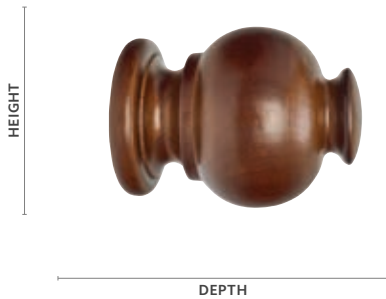

Fits		Dimensions		Quantity per Box
2" Wood Trends™ Poles 2" Estate™ Traverse Rods		Depth: 4 3/8"	Height: 3 1/2"	10 pieces per box
		Width: 3 1/2"		
Product Number & Finish				
46813059	Black	46813820	Estate Oak	46813835 Truffle
46813841	Coffee	46813083	Mahogany	46813025 White
46813825	Dark Chocolate	46813830	Marble	46813091 Unfinished

Chaucer

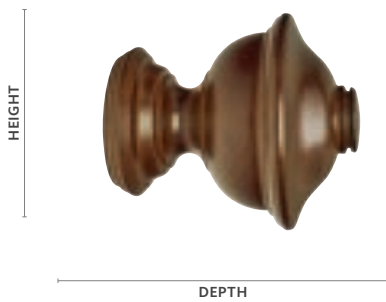

Fits		Dimensions		Quantity per Box
2" Wood Trends™ Poles 2" Estate™ Traverse Rods		Depth: 4 3/8"	Height: 3 3/4"	10 pieces per box
		Width: 3 3/4"		
Product Number & Finish				
46807059	Black	46807820	Estate Oak	46807835 Truffle
46807841	Coffee	46807083	Mahogany	46807025 White
46807825	Dark Chocolate	46807830	Marble	46807091 Unfinished

Ethan



Fits		Dimensions		Quantity per Box
2" Wood Trends™ Poles 2" Estate™ Traverse Rods		Depth: 4"	Height: 4 3/4"	10 pieces per box
		Width: 4 3/4"		
Product Number & Finish				
46814059	Black	46814820	Estate Oak	46814835 Truffle
46814841	Coffee	46814083	Mahogany	46814025 White
46814825	Dark Chocolate	46814830	Marble	46814091 Unfinished

Hugo



Fits		Dimensions		Quantity per Box
2" Wood Trends™ Poles 2" Estate™ Traverse Rods		Depth: 2 7/8"	Height: 3 3/4"	10 pieces per box
		Width: 3 3/4"		
Product Number & Finish				
46815059	Black	46815820	Estate Oak	46815835 Truffle
46815841	Coffee	46815083	Mahogany	46815025 White
46815825	Dark Chocolate	46815830	Marble	46815091 Unfinished

2" Finials & Endcaps

Miller



Fits	Dimensions	Quantity per Box
2" Wood Trends™ Poles 2" Estate™ Traverse Rods	Depth: 3½" Height: 4½" Width: 4½"	10 pieces per box

Product Number & Finish					
46816059	Black	46816820	Estate Oak	46816835	Truffle
46816841	Coffee	46816083	Mahogany	46816025	White
46816825	Dark Chocolate	46816830	Marble	46816091	Unfinished

Sherwood



Fits	Dimensions	Quantity per Box
2" Wood Trends™ Poles 2" Estate™ Traverse Rods	Depth: 5" Height: 3" Width: 3"	10 pieces per box

Product Number & Finish					
5509EG059	Black	5509EG820	Estate Oak	5509EG835	Truffle
5509EG841	Coffee	5509EG083	Mahogany	5509EG025	White
5509EG825	Dark Chocolate	5509EG830	Marble	5509EG091	Unfinished

Warren



Fits	Dimensions	Quantity per Box
2" Wood Trends™ Poles 2" Estate™ Traverse Rods	Depth: 1⅞" Height: 3¾" Width: 3¾"	10 pieces per box

Product Number & Finish					
46817059	Black	46817820	Estate Oak	46817835	Truffle
46817841	Coffee	46817083	Mahogany	46817025	White
46817825	Dark Chocolate	46817830	Marble	46817091	Unfinished

Wood Ball

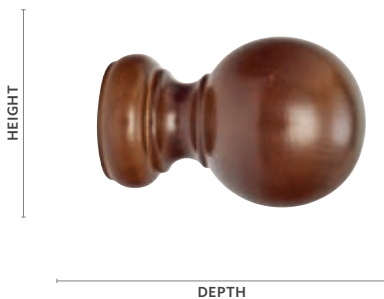

Fits	Dimensions	Quantity per Box
2" Wood Trends™ Poles 2" Estate™ Traverse Rods	Depth: 5¼" Height: 3¾" Width: 3¾"	10 pieces per box

Product Number & Finish					
5508EG059	Black	5508EG820	Estate Oak	5508EG835	Truffle
5508EG841	Coffee	5508EG083	Mahogany	5508EG025	White
5508EG825	Dark Chocolate	5508EG830	Marble	5508EG091	Unfinished

2" Finials & Endcaps

Endcap



Fits	Dimensions	Quantity per Box
2" Wood Trends™ Poles 2" Estate™ Traverse Rods	Depth: 1½" Height: 3" Width: 3"	10 pairs per box

Product Number & Finish					
46808059	Black	46808820	Estate Oak	46808835	Truffle
46808841	Coffee	46808083	Mahogany	46808025	White
46808825	Dark Chocolate	46808830	Marble	46808091	Unfinished



Chaucer | Dark Chocolate

1 3/8" Fluted Pole | Estate Oak

2" Fluted Pole | Black

2" Smooth Pole | Marble

1 3/8" Smooth Pole | Coffee



2" Poles

4' Smooth Pole



Diameter	Length	Quantity per Box
2"	4'	2 pieces per box

Product Number & Finish

55014G059 Black	55014G820 Estate Oak	55014G835 Truffle
55014G841 Coffee	55014G083 Mahogany	55014G025 White
55014G825 Dark Chocolate	55014G830 Marble	55014G091 Unfinished

4' Fluted Pole

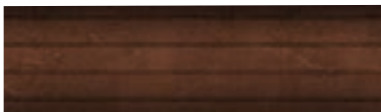

Diameter	Length	Quantity per Box
2"	4'	2 pieces per box

Product Number & Finish

55004G059 Black	55004G820 Estate Oak	55004G835 Truffle
55004G841 Coffee	55004G083 Mahogany	55004G025 White
55004G825 Dark Chocolate	55004G830 Marble	55004G091 Unfinished

6' Smooth Pole

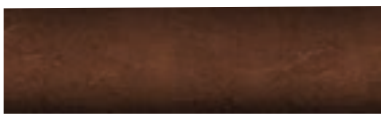

Diameter	Length	Quantity per Box
2"	6'	2 pieces per box

Product Number & Finish

55016G059 Black	55016G820 Estate Oak	55016G835 Truffle
55016G841 Coffee	55016G083 Mahogany	55016G025 White
55016G825 Dark Chocolate	55016G830 Marble	55016G091 Unfinished

6' Fluted Pole

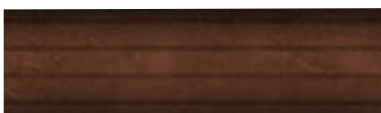

Diameter	Length	Quantity per Box
2"	6'	2 pieces per box

Product Number & Finish

55006G059 Black	55006G820 Estate Oak	55006G835 Truffle
55006G841 Coffee	55006G083 Mahogany	55006G025 White
55006G825 Dark Chocolate	55006G830 Marble	55006G091 Unfinished

2" Poles

8' Smooth Pole



Diameter	Length	Quantity per Box
2"	8'	2 pieces per box

Product Number & Finish

55018G059 Black	55018G820 Estate Oak	55018G835 Truffle
55018G841 Coffee	55018G083 Mahogany	55018G025 White
55018G825 Dark Chocolate	55018G830 Marble	55018G091 Unfinished

8' Fluted Pole

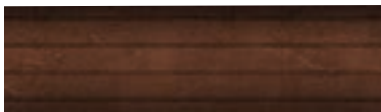

Diameter	Length	Quantity per Box
2"	8'	2 pieces per box

Product Number & Finish

55008G059 Black	55008G820 Estate Oak	55008G835 Truffle
55008G841 Coffee	55008G083 Mahogany	55008G025 White
55008G825 Dark Chocolate	55008G830 Marble	55008G091 Unfinished

12' Smooth Pole

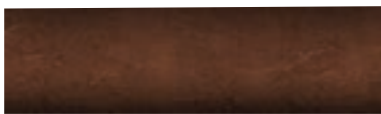

Diameter	Length	Quantity per Box
2"	12'	2 pieces per box

Product Number & Finish

550112G059 Black	550112G820 Estate Oak	550112G835 Truffle
550112G841 Coffee	550112G083 Mahogany	550112G025 White
550112G825 Dark Chocolate	550112G830 Marble	550112G091 Unfinished

12' Fluted Pole

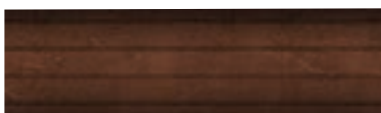

Diameter	Length	Quantity per Box
2"	12'	2 pieces per box

Product Number & Finish

550012G059 Black	550012G820 Estate Oak	550012G835 Truffle
550012G841 Coffee	550012G083 Mahogany	550012G025 White
550012G825 Dark Chocolate	550012G830 Marble	550012G091 Unfinished

2" Estate™ Traverse Rods

To learn more about the technical specs on Estate Traverse Rods and AMP™ Motorization, see pages 36-39.

Assembled Set with Slides



Manual Traversing Rods with Selected Carriers

Unit of Measure

Foot

AMP™ Motorization Upcharge

Charger, item #62201300 included. Remotes sold separately.

Product Number & Finish

95675059	Black	95675820	Estate Oak	95675835	Truffle
95675841	Coffee	95675083	Mahogany	95675025	White
95675825	Dark Chocolate	95675830	Marble		

Assembled Set with Wheeled Ripplefold™ Carriers



Manual Traversing Rods with Selected Carriers

Unit of Measure

Foot

AMP™ Motorization Upcharge

Charger, item #62201300 included. Remotes sold separately.

Product Number & Finish

95676058	Black	95676820	Estate Oak	95676835	Truffle
95676841	Coffee	95676083	Mahogany	95676025	White
95676825	Dark Chocolate	95676830	Marble		

Double Bracket

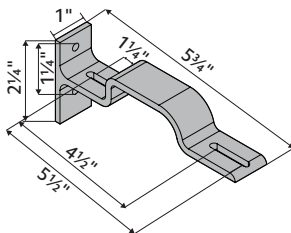

Fits

1 3/8" Estate™ Traverse Rods
2" Estate™ Traverse Rods

Dimensions

Depth: 5 3/4"
Height: 2 1/4"
Width: 1"

Quantity per Box

10 pieces per box

Product Number & Finish

71134110 Satin Brass

Double Bracket

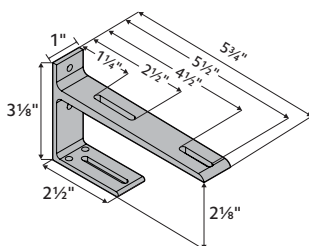

Fits

1 3/8" Estate™ Traverse Rods
2" Estate™ Traverse Rods

Dimensions

Depth: 5 3/4"
Height: 3 1/8"
Width: 1"

Quantity per Box









10 pieces per box

Product Number & Finish

71132062	Antique Brass	71132110	Satin Brass
71132006	Black	71132012	Satin Nickel

2" Estate™ Traverse Rod Components

To learn more about the technical specs on Estate Traverse Rods and AMP™ Motorization, see pages 36-39.

Item	Product No. & Finish	Description	Quantity Per Box
	62101000 White 62101010 Black	AMP Remote Control RF 2W 15 Channel	1 piece per box
	62201300 White	AMP Battery Charger 16.5V/0.89A	1 piece per box
	62102000 White	AMP Gateway USB Bridge	1 piece per box
	62109000 White	AMP Wall Switch Surface RF 2W 15 Channel	1 piece per box
	62108000 White	AMP Wall Switch RF 2W 15 Channel	1 piece per box
	1026660	15" Cable Assembly	10 pieces per box
	1026661	4' Cable Assembly	10 pieces per box
	1026662	10' Cable Assembly	10 pieces per box
	1026663	20' Cable Assembly	10 pieces per box

2" Rings

Ring with Eyelet



Fits	Dimensions	Quantity per Box
2" Wood Trends™ Poles	Internal: 2¾" External: 3⅝" External to eyelet: 4¼"	10 bags per box - 4 rings per bag

Product Number & Finish		
5502EG059 Black	5502EG820 Estate Oak	5502EG835 Truffle
5502EG481 Coffee	5502EG083 Mahogany	5502EG025 White
5502EG825 Dark Chocolate	5502EG830 Marble	5502EG091 Unfinished

Metal clip, item 5605BB063 can be ordered separately.



Rings with
Removable Clips

- Estate Oak
- Coffee
- Truffle
- Black
- Marble

Rings with Eyelet

- White
- Black
- Mahogany
- Estate Oak

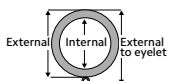

Use the measurement guide to the left to help determine the correct dimensions for your selected product.

2" Brackets

3½" Return Wood Bracket



Fits	Dimensions	Quantity per Box
2" Wood Trends™ Poles	Depth: 5½" Height: 4¾" Width: 1" Wall to Pole: 2½" Return: 3½"	10 pieces per box

Product Number & Finish

5503EG059 Black	5503EG820 Estate Oak	5503EG835 Truffle
5503EG841 Coffee	5503EG083 Mahogany	5503EG025 White
5503EG825 Dark Chocolate	5503EG830 Marble	5503EG091 Unfinished

6" Return Wood Bracket



Fits	Dimensions	Quantity per Box
2" Wood Trends™ Poles	Depth: 8" Height: 4¾" Width: 1" Wall to Pole: 5" Return: 6"	5 pieces per box

Product Number & Finish

5511EG059 Black	5511EG820 Estate Oak	5511EG835 Truffle
5511EG841 Coffee	5511EG083 Mahogany	5511EG025 White
5511EG825 Dark Chocolate	5511EG830 Marble	5511EG091 Unfinished

Ceiling Mount Bracket



Fits	Dimensions	Quantity per Box
2" Wood Trends™ Poles	Depth: 6" Height: 6" Width: 1" Ceiling to Pole: 5⅝" Back Edge to Pole: 2⅞"	5 pieces per box

Product Number & Finish

46850059 Black	46850820 Estate Oak	46850835 Truffle
46850841 Coffee	46850083 Mahogany	46850025 White
46850825 Dark Chocolate	46850830 Marble	

Double Bracket



Fits	Dimensions	Quantity per Box
Front: 2" Wood Trends™ Poles Back: 1⅜" Wood Trends™ Poles	Depth: 9" Height: 4¾" Width: 1" Wall to Back Pole: 2⅜" Inner Return: 3" Outer Return: 7"	5 pieces per box

Product Number & Finish

5520EG059 Black	5520EG820 Estate Oak	5520EG835 Truffle
5520EG841 Coffee	5520EG083 Mahogany	5520EG025 White
5520EG825 Dark Chocolate	5520EG830 Marble	

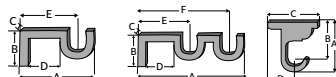

Use the measurement guide to the left to help determine the correct dimensions for your selected product.

2" Components

Swivel Socket



Fits	Dimensions	Quantity per Box
2" Wood Trends™ Poles	Length to Center: 3½" Pole Diameter: 2⅛" Full Length: 4⅞" Depth of Socket: 1¾"	5 pieces per box
Product Number & Finish		
5506EG059 Black	5506EG820 Estate Oak	5506EG835 Truffle
5506EG841 Coffee	5506EG083 Mahogany	5506EG025 White
5506EG825 Dark Chocolate	5506EG830 Marble	5506EG091 Unfinished

Elbow - 3½"-5½" Clearance



Fits	Clearance	Quantity per Box
2" Wood Trends™ Poles	3½"-5½"	10 pieces per box
Product Number & Finish		
5513091	Unfinished	

See page 53 for configuration

Elbow - 6"-8" Clearance



Fits	Clearance	Quantity per Box
2" Wood Trends™ Poles	6"-8"	10 pieces per box
Product Number & Finish		
5517091	Unfinished	

See page 53 for configuration

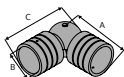

Use the measurement guide to the left to help determine the correct dimensions for your selected product.

2" Components

Metal Bracket

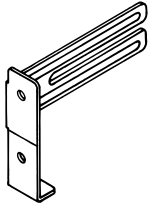

See page 53 for configuration

Fits	Quantity per Box
For use on wood elbows	20 pieces per box

Product Number & Finish
5623063 Brass

Hidden Metal Support - 2½"-3½" Clearance

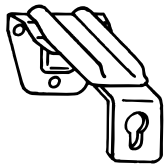

See page 53 for configuration

Clearance	Quantity per Box
2½"-3½"	20 pieces per box

Product Number & Finish
5618063 Brass

Hidden Metal Support - 4"-5½" Clearance

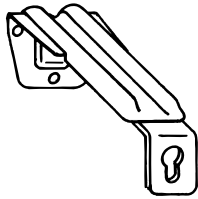

See page 53 for configuration

Clearance	Quantity per Box
4"-5½"	20 pieces per bag

Product Number & Finish
5619063 Brass

Accessories & Components

3¾" Holdback Medallion

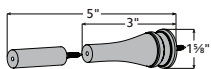

Dimensions		Quantity per Box			
Depth: 3"-5" Adjustable post arm with 3" or 5" clearance included.		4 pairs per box			
Height: 3¾"					
Width: 3¾"					
Product Number & Finish					
46865059	Black	46865820	Estate Oak	46865835	Truffle
46865841	Coffee	46865083	Mahogany	46865025	White
46865825	Dark Chocolate	46865830	Marble		

Pole Connector



Fits		Quantity per Box	
All Wood Trends™ Poles		20 pieces per box	
Product Number & Finish			
5610E061	Zinc Plated		

Metal Clip



Dimensions		Quantity per Box	
Rings with Eyelets		50 pieces per bag	
Product Number & Finish			
5605BB063	Brass		

Teflon Tape



Dimensions		Quantity per Box	
54' per roll		1 roll per bag	
Product Number & Finish			
84990000	Clear		

Teflon tape is used on stationary poles to help rings slide smoothly across the pole.

AMP™ Motorization

Why AMP™?

The slim design of the quiet, yet powerful motor and the position on the track allows the motor to tuck seamlessly behind your drapery panel so you'll never have to sacrifice your style or comfort. For safety measures, you're able to move the draperies with a gentle tug, allowing for operation when a remote is not present or if a guest is unaware of the motorization feature. The dual battery and AC power sources allows operation in case of a power outage so draperies may be opened in the event of an emergency. AMP™ Motorization is available on our most popular traversing tracks, Estate and Architrac® Series 94001 and in drapery header styles Ripplefold™ and pleated for a variety of styling options. This is comfortable living at its finest.

For AMP™ Motorization brochure, programming instructions and installation instructions, please visit the drapery hardware resource library at kirsch.com.

Benefits & Features

AMP™ Motorization

- Motor mounts to the back of the track which allows a seamless look between motorized and manual traverse rods
- Drapery fabrication does not need to change between manually controlled draperies and motorized draperies; No additional returns or any special instructions
- Limits are set automatically after installation
- Remote control is radio frequency and easily pairs with the motor
- Tug feature; when drapery is pulled the motor will traverse the drapery
- AMP™ App with AMP™ USB Bridge
- Architrac® Series 94001 Rods with AMP™ cannot be bent or curved

Frequently Asked Questions

What is the weight capacity?

64 lbs Motor is rated to 64 lbs. Be sure not to exceed the Estate or Architrac track specifications to ensure your motor operates optimally.

Can you double the weight capacity by using two motors?

No Only use one motor per rod.

Does AMP™ offer limit setting?

Yes The motor automatically sets its limits.

Does AMP™ offer touch control?

Yes The tug feature allows you to pull on the drapery and the motor will automatically open or close your draperies.

How long is the power cord?

6 ft The durable, non-extendable power cord is extra long for out of reach places. Any extra can be rolled and secured for a tidy look. Cable extensions are available in 15", 4', 10' and 20' lengths to reach outlets that are farther away from the motor.

Is there a wall switch?

Yes There are Flush Mount and Surface Mount Wall Switches available.

Does AMP™ offer a warranty?

Yes See the Kirsch Warranty document for more information.

Download the AMP™ APP to get started



AMP™ Motorization Overview

Overview

- Soft start/stop & manual operation
- Tug feature: when drapery is pulled the motor will traverse the drapery
- Automatic limits on end stop
- Favorite/intermediate position
- Dry contact for external control
- RF Remote and wall switches
- Setting with buttons on motor units
- Setting with external dry contact switch
- LED Indicators
- One-Way and Two-Way Draw
- Pleated
- Ripplefold™
- AMP™ App with AMP™ USB Bridge

Available Colors



White

Side View



Front View

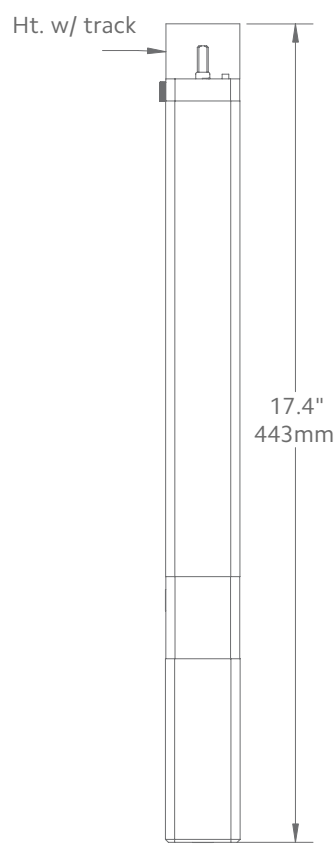

Bottom View

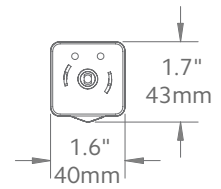

Motor Unit	Product No.
AMP™ Drapery Motor	62001300

Technical Specs	AMP™ Motor
Power Supply	DC 16.5V-0.89A (100-240VAC 50/60Hz 0.5A)
Amperage	2.55Ah
Average Linear Speed	7.8inches/sec
Power Consumption	40 watts
Torque	1.2Nm
Power Cable Length	6 feet
Variable Speed	80, 100 & 120 rpm
Certifications	UL/CE
Max. Track Length	Estate™ - 16 ft Architrac™ 94001 - 16 ft
Max. Load	64 lbs

Follow track specifications for drapery weight.



Estate™ Overview

To help determine which system is right for your project, use the guideline below to select the best fit. For more detailed information about each track, please visit our resource library at kirsch.com.

Estate™ Series	Designer Metals™	Wood Trends™	Wrought Iron
What is your preferred size?			
1 3/8"	•	•	•
2"	•	•	
What is your preferred Draw type?			
Motorized	•	•	•
Manual	•	•	•
What is your preferred Drapery Heading type?			
Pleated	•	•	•
Ripplefold™	•	•	•
What is your mounting location?			
Ceiling Mount*	•	•	•
Wall Mount	•	•	•

*Final choices may be limited for ceiling mounted Estate™ Rods.

Track Performance Data

Style	Heading Style	Mount	Draw	Minimum Track Length	Maximum Track Length	Minimum Fabric Weight	Lbs. per Ft.
 83611 1 3/8" Estate™ Manual or Motorized Draw	Pleated, Ripplefold™	Ceiling, Wall	One-Way	18 in	16 ft	64 lbs	4
			Two-Way	18 in	16 ft	64 lbs	4
 93601 2" Estate™ Manual or Motorized Draw	Pleated, Ripplefold™	Ceiling, Wall	One-Way	18 in	16 ft	64 lbs	4
			Two-Way	18 in	16 ft	64 lbs	4

*Maximum track lengths and maximum fabric weight do not apply to curved track. Check with customer service for feasibility. Send complete specifications and fabric weight.

Operating Systems

Motorized Draw

AMP™ Motorization

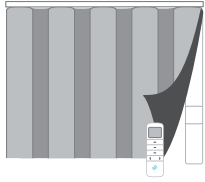

- Easy to use
- Quiet, powerful motor
- Pleated or Ripplefold™
- For Estate™ Traverse Rods or Architrac® Series 94001
- For more information, see page 46

Manual Draw

Cord Draw

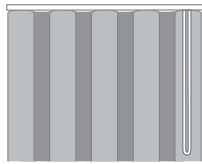

- Easy to use
- Pleated or Ripplefold™

Hand/Baton Draw



- Easy to use
- A gentle tug allows drapery to glide across track
- Pleated or Ripplefold™

Baton Duplex Draw

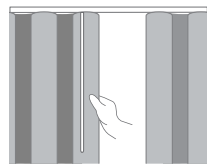

- Easy to use
- Used on split draw rods
- Pleated or Ripplefold™
- When the baton is pulled on one stack, draperies on both sides of the traverse rod open or close

Header Styles

Ripplefold™

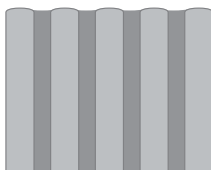

- Panels can be pressed flat, yet fall into fold
- No hooks or pins
- Headings are suspended under track
- Stack back is less than conventional pleated draperies
- Draperies snap on/off carriers for easy installation
- Interior drapery appearance is identical to exterior-facing appearance

Pleated

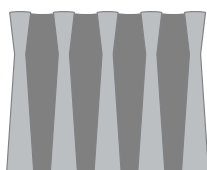

- A classic header option
- Can be used with most track systems using slip-in or pin-on hooks
- Headings can be suspended under the track or over the face of the track to conceal hardware
- Four carriers per foot is standard, additional carriers or rings can be ordered

Bracket Spacing & Mount Options

Place brackets at each end. On the ends where the drapery will stack, place the next bracket at a maximum of 24" from the first bracket, then place remaining brackets at 48" intervals over the remainder of the track. Spacing may need to be shortened for heavier draperies. All mounting options are compatible with our AMP™ Motorization.

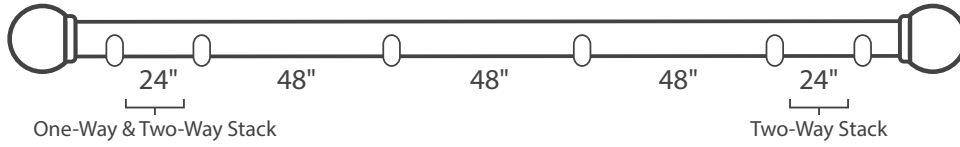

Wall Mount using parts:

To achieve this look, order Estate rod, wall mount and all components will be included.

94129061
Zinc

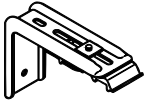

or

1856973
Satin Nickel

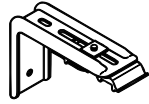

or

1856978
Brushed Bronze

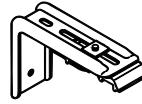

or

1857324
Black



1 3/8" Wall Mount

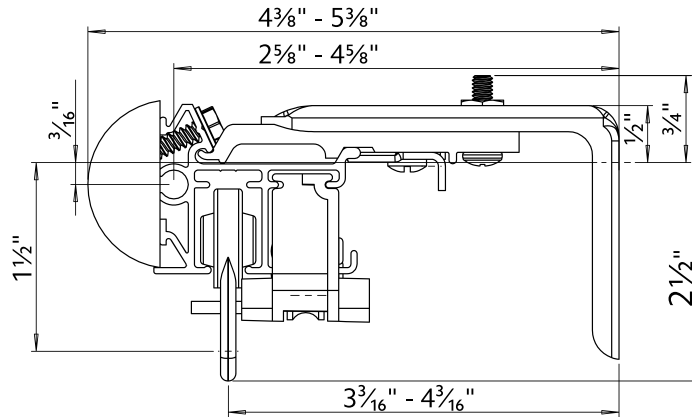

2" Wall Mount

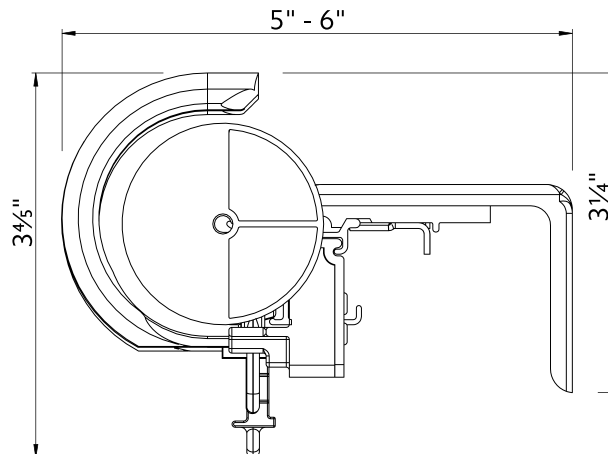

Ceiling Mount using parts:

To achieve this look, order Estate rod, ceiling mounted. 94130xxx brackets are included with the rod. Then order item 1796061 ceiling mount bracket in the quantity needed based on the bracket spacing drawing on page 40.

94130xxx



⊗

1796061

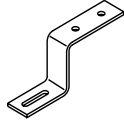

1 3/8" Ceiling Mount

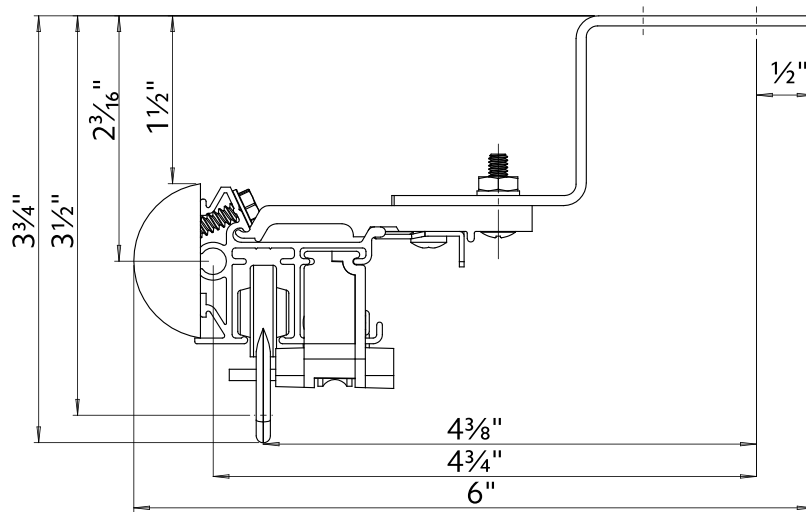

2" Ceiling Mount

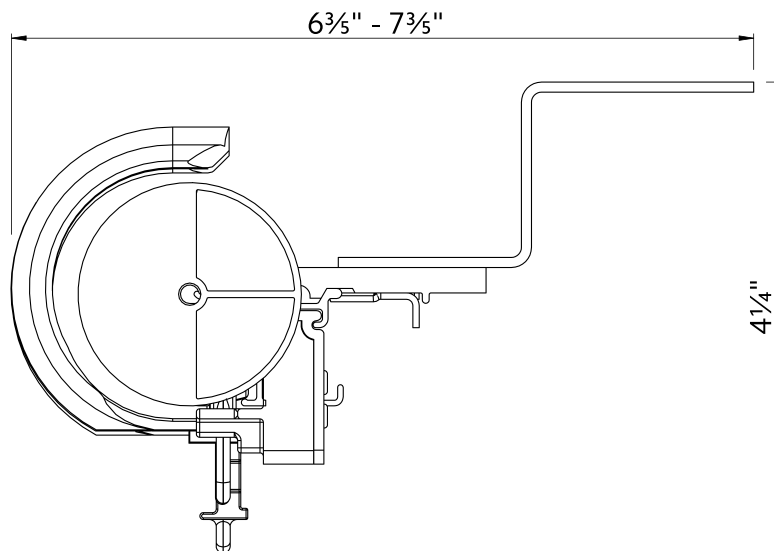

Double Wall Mount using parts:

To achieve this look, order Estate rod, ceiling mounted. 94130xxx brackets are included with the rod. Then order one, item 94125xxx double bracket and two, item 1796061 ceiling mount brackets multiplied by the quantity needed based on the bracket spacing drawing on page 40.

94125xxx



⊕

1796061

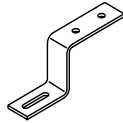

⊕

94130xxx



1 3/8" Double Wall Mount

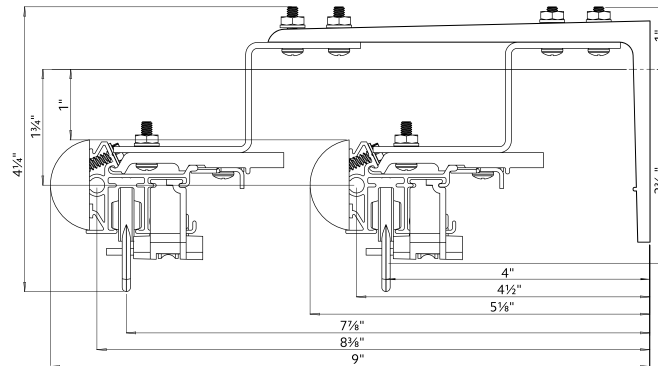

2" Double Wall Mount

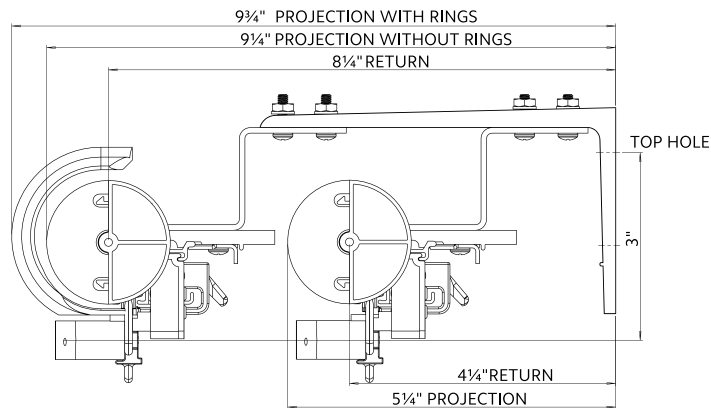

2" Front & 1 3/8" Back Double Wall Mount

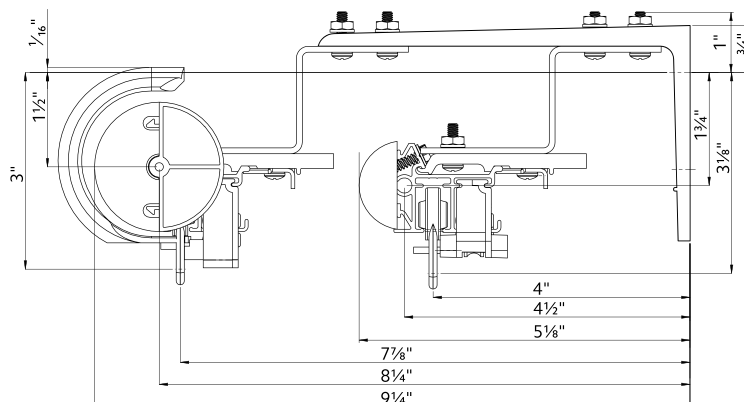

Double Wall Mount using parts:

To achieve this look, order Estate rod ceiling mounted. 94130xxx brackets are included with the rod. Then order one, item 71134110 double bracket in the quantity needed based on the bracket spacing drawing on page 40.

71134110

&

94130xxx

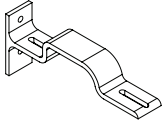

2" Front & 1 3/8" Back Double Wall Mount

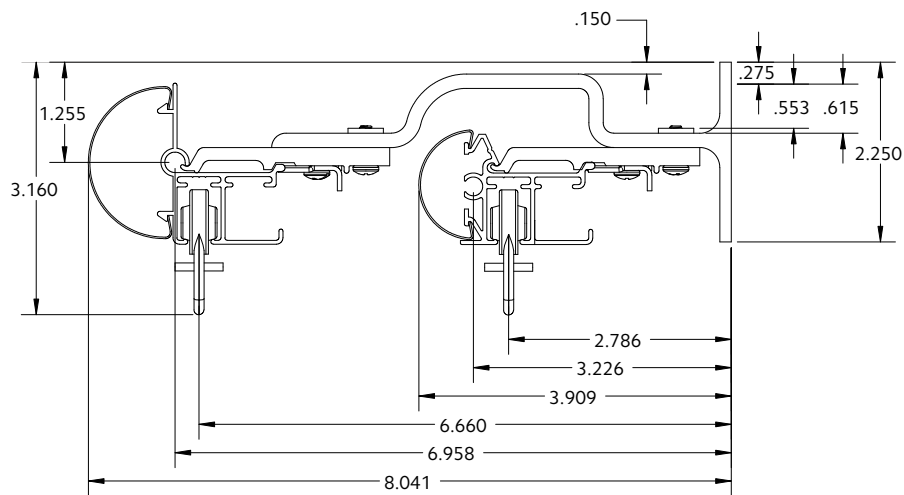

1 3/8" Front & 1 3/8" Back Double Wall Mount

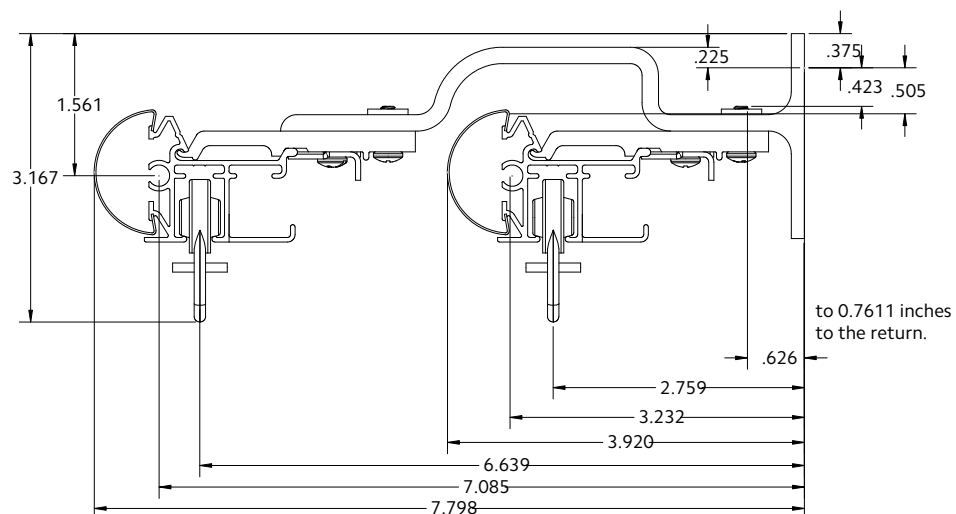

Calculating Drapery Weight

1. Fabric Weight

Some fabric samples list on the back of the swatch the weight listed in Ounces/SqYd (ounces per square yard). Call the manufacturer for the weight if not listed.

2. Lining Weight

Most drapery linings are 2oz - 4oz per square yard.

Drapery Weight Formula

Total Square Yards = (total yards x 36 x fabric width) ÷ 1296 (1-square yard)

Weight = total square yards x weight in ounces per SqYd) ÷ 16 oz in lb

Example 32 yards of 54" wide fabric weighing 14 oz/SqYd
Total square yards = (32 x 36 x 54) = 62,208 ÷ 1296 = 48 SqYds
Weight = (48 x 14oz) = 672 ÷ 16 = 42 lbs

Lining Weight Formula

Total Square Yards = (total yards x 36 x fabric width) ÷ 1296 (1-square yard)

Weight = total square yards x weight in ounces per SqYd) ÷ 16 oz in lb

Example 32 yards of 54" wide fabric weighing 6 oz/SqYd
Total square yards = (32 x 36 x 54) = 62,208 ÷ 1296 = 48 SqYds
Weight = (48 x 4oz) = 192 ÷ 16 = 12 lbs

Fabrics by Weight

Contact the fabric manufacturer for your specific fabric weight.

Fabric Type	Weight per Square Yard
Drapery Lining	2-4oz
Interlining	5-6oz
Blackout Lining	6-10oz
Bump Lining	12-14oz
Silks	2-4oz
Chintz	2-4oz
Printed Cottons	4-6oz
Linens	6-10oz
Jacquards	10-14oz
Velvets	14-18oz

Stack Guides

Pleated Stack Guide (for 16 mm carriers)

Note: Stack size is estimated. Type of fabric used could alter these measurements.

Size of Track (in inches)	5 carriers per foot 3x fullness		4 carriers per foot 2½x fullness		3 carriers per foot 2x fullness	
	Stackback One-Way	Stackback Two-Way (per side)	Stackback One-Way	Stackback Two-Way (per side)	Stackback One-Way	Stackback Two-Way (per side)
18	11.75	8.75	10.5	8.5	10.5	8.5
24	13	9.25	11.75	8.75	10.5	8.5
30	15.75	10.5	13	9.25	11.75	8.75
36	17	11.25	14.5	10	13	9.25
42	18.5	12	15.75	10.5	14.5	10
48	19.75	12.5	17	11.25	14.5	10
54	22.25	14	18.5	12	15.75	10.5
60	23.75	14.5	19.75	12.5	17	11.25
66	25	15.25	21	13.25	18.5	12
72	26.25	16	22.25	14	18.5	12
78	29	17.25	23.75	14.5	19.75	12.5
84	30.25	18	25	15.25	21	13.25
90	31.5	18.5	26.25	16	22.25	14
96	33	19.25	27.5	16.5	22.25	14
102	35.5	20.5	29	17.25	23.75	14.5
108	36.75	21.25	30.25	18	25	15.25
114	38.25	21.75	31.5	18.5	26.25	16
120	39.5	22.5	33	19.25	26.25	16
126	42.25	23.75	34.25	19.75	27.5	16.5
132	43.5	24.5	35.5	20.5	29	17.25
138	44.75	25.25	36.75	21.25	30.25	18
144	46	25.75	38.25	21.75	30.25	18
150	48.75	27	39.5	22.5	31.5	18.5
156	50	27.75	40.75	23.25	33	19.25
162	51.5	28.5	42.25	23.75	34.25	19.75
168	52.75	29	43.5	24.5	34.25	19.75
174	55.25	30.5	44.75	25.25	35.5	20.5
180	56.75	31	46	25.75	36.75	21.25
186	58	31.75	47.5	26.5	38.25	21.75
192	59.25	32.5	48.75	27	38.25	21.75
198	62	33.75	50	27.75	39.5	22.5
204	63.25	34.5	51.5	28.5	40.75	23.25
210	64.5	35	52.75	29	42.25	23.75
216	66	35.75	54	29.75	42.25	23.75
222	68.5	37	55.25	30.5	43.5	24.5
228	69.75	37.75	56.75	31	44.75	25.25
234	71.25	38.25	58	31.75	46	25.75
240	72.5	39	59.25	32.5	46	25.75

Ripplefold™ Stack Guide for Butt Master 84111xxx

Note: Stack size is estimated. Type of fabric used could alter these measurements. Please refer to the Ripplefold Fabrication Manual for more information.

120% Fullness	100% Fullness	80% Fullness	60% Fullness	Number of factory snaps	Snap Tape Length (less return length)*	Panel Stackback
13⅜	15⅜	17⅞	18⅞	8	32½	5½
17⅜	19⅝	21⅞	24⅞	10	41	6½
21⅞	23⅞	26⅞	29⅞	12	49½	7½
24⅞	28⅞	31⅞	34⅞	14	58	8¾
28⅞	32⅞	36⅞	39⅞	16	66½	9¾
32⅞	36⅞	40⅞	45⅞	18	75	11
36⅞	40⅞	45⅞	50⅞	20	83½	12
39⅞	45⅞	50⅞	55⅞	22	92	13
45⅞	49⅞	55⅞	60⅞	24	100½	14¼
47⅞	53⅞	59⅞	66⅞	26	109	15¼
51⅞	57⅞	64⅞	71⅞	28	117½	16½
54⅞	62⅞	69⅞	76⅞	30	126	17½
58⅞	66⅞	74⅞	81⅞	32	134½	18½
62⅞	70⅞	78⅞	87⅞	34	143	19¾
66⅞	74⅞	83⅞	92⅞	36	151½	20¾
69⅞	79⅞	88⅞	97⅞	38	160	22
73⅞	83⅞	93⅞	102⅞	40	168½	23
77⅞	87⅞	97⅞	108⅞	42	177	24
81⅞	91⅞	102⅞	113⅞	44	185½	25¼
84⅞	96⅞	107⅞	118⅞	46	194	26¼
88⅞	100⅞	112⅞	123⅞	48	202½	27½
92⅞	104⅞	116⅞	129⅞	50	211	28½
96⅞	108⅞	121⅞	134⅞	52	219½	29½
99⅞	113⅞	126⅞	139⅞	52	228	30¾
103⅞	117⅞	131⅞	144⅞	54	236½	31¾
107⅞	121⅞	135⅞	150⅞	56	245	33
111⅞	125⅞	140⅞	155⅞	58	253½	34
114⅞	130⅞	145⅞	160⅞	60	262	35
118⅞	134⅞	150⅞	165⅞	62	270½	36¼
122⅞	138⅞	154⅞	171⅞	64	279	37¼
126⅞	142⅞	159⅞	176⅞	66	287½	38½
129⅞	147⅞	164⅞	181⅞	68	296	39 ½
133⅞	151⅞	169⅞	186⅞	70	304½	40½
137⅞	155⅞	173⅞	192⅞	72	313	41¾
141⅞	159⅞	178⅞	197⅞	74	321½	42¾
144⅞	164⅞	183⅞	202⅞	76	330	44

Ripplefold™ Stack Guide for Butt Master 8411xxx

Note: Stack size is estimated. Type of fabric used could alter these measurements. Please refer to the Ripplefold Fabrication Manual for more information.

120% Fullness	100% Fullness	80% Fullness	60% Fullness	Number of factory snaps	Snap Tape Length (less return length)*	Panel Stackback
148⅝	168⅝	188⅝	207⅝	78	338½	45
152⅝	176⅝	192⅝	213⅝	80	347	46
156⅝	176⅝	197⅝	218⅝	84	355½	47¼
159⅝	181⅝	202⅝	223⅝	86	364	48¼
163⅝	185⅝	207⅝	228⅝	88	372½	49½
167⅝	189⅝	211⅝	234⅝	90	381	50½
171⅝	193⅝	216⅝	239⅝	92	389½	51½
174⅝	198⅝	221⅝	244⅝	94	398	52¾
178⅝	202⅝	226⅝	249⅝	96	406½	53¾
182⅝	206⅝	230⅝	255⅝	98	415	55
186⅝	210⅝	235⅝	260⅝	100	423½	56
189⅝	215⅝	240⅝	265⅝	102	432	57
193⅝	219⅝	245⅝	270⅝	104	440½	58¼
197⅝	223⅝	249⅝	276⅝	106	449	59¼
201⅝	227⅝	254⅝	281⅝	108	457½	60½
204⅝	232⅝	259⅝	286⅝	110	466	61½
208⅝	236⅝	264⅝	291⅝	112	474½	62 ½
212⅝	240⅝	268⅝	297⅝	114	483	63¾
216⅝	244⅝	273⅝	302⅝	116	491½	64¾
219⅝	249⅝	278⅝	307⅝	118	500	66
223⅝	253⅝	283⅝	312⅝	120	508½	67
227⅝	257⅝	287⅝	318⅝	122	517	68
231⅝	261⅝	292⅝	323⅝	124	525½	69¼
234⅝	266⅝	297⅝	328⅝	126	534	70¼
238⅝	270⅝	302⅝	333⅝	128	542½	71½
242⅝	274⅝	306⅝	339⅝	130	551	72½
246⅝	278⅝	311⅝	344⅝	132	559½	73½
249⅝	283⅝	316⅝	349⅝	134	568	74¾
253⅝	287⅝	321⅝	354⅝	136	576½	75¾
257⅝	291⅝	325⅝	360⅝	138	585	77
261⅝	295⅝	330⅝	365⅝	140	593½	78
264⅝	300⅝	335⅝	370⅝	142	602	79
268⅝	304⅝	340⅝	375⅝	144	610½	80¼
272⅝	308⅝	344⅝	381⅝	146	619	81¼
276⅝	312⅝	349⅝	386⅝	148	627½	82½
279⅝	317⅝	354⅝	391⅝	150	636	83½

Ripplefold™ Stack Guide for Butt Master 84214xxx

Note: Stack size is estimated. Type of fabric used could alter these measurements. Please refer to the Ripplefold Fabrication Manual for more information.

120% Fullness	100% Fullness	80% Fullness	60% Fullness	Number of factory snaps	Snap Tape Length (less return length)*	Panel Stackback
14⅞	16⅜	17⅞	19⅜	8	32½	7½
18⅝	20⅝	22⅝	24⅝	10	41	8½
22⅜	24⅞	27⅜	29⅞	12	49½	9¾
26⅞	29⅞	32⅞	35⅞	14	58	10¾
29⅞	33⅜	36⅞	40⅜	16	66½	12
33⅝	37⅝	41⅝	45⅝	18	75	13
37⅜	41⅞	46⅜	50⅞	20	83½	14
41⅞	46⅞	51⅞	56⅞	22	92	15¼
44⅞	50⅜	55⅞	61⅜	24	100½	16¼
48⅝	54⅝	60⅝	66⅝	26	109	17½
52⅜	58⅞	65⅜	71⅞	28	117½	18½
56⅞	63⅞	70⅞	77⅞	30	126	19½
59⅞	67⅜	74⅞	82⅜	32	134½	20¾
63⅝	71⅞	79⅝	87⅝	34	143	21¾
67⅜	75⅞	84⅜	92⅞	36	151½	23
71⅞	80⅞	89⅞	98⅞	38	160	24
74⅞	84⅜	93⅞	103⅜	40	168½	25
78⅝	88⅝	98⅝	108⅝	42	177	26¼
82⅜	92⅞	103⅜	113⅞	44	185½	27¼
86⅞	97⅞	108⅞	119⅞	46	194	28½
89⅞	101⅜	112⅞	124⅜	48	202½	29½
93⅝	105⅝	117⅝	129⅝	50	211	30½
97⅜	109⅞	122⅜	134⅞	52	219½	31¾
101⅞	114⅞	127⅞	140⅞	54	228	32¾
104⅞	118⅜	131⅞	145⅜	56	236½	34
108⅝	122⅝	136⅝	150⅝	56	245	35
112⅜	126⅞	141⅜	155⅞	60	253½	36¼
116⅞	131⅞	146⅞	161⅞	62	262	37¼
119⅞	135⅜	150⅞	166⅜	64	270½	38¼
123⅜	139⅝	155⅝	171⅝	66	279	39½
127⅜	143⅞	160⅜	176⅞	68	287½	40½
131⅞	148⅞	165⅞	182⅞	70	296	41¾
134⅞	152⅜	169⅞	187⅜	72	304½	42¾
138⅝	156⅝	174⅝	192⅝	74	313	43¾
142⅜	160⅞	179⅜	197⅞	76	321½	45
146⅞	165⅞	184⅞	203⅞	78	330	46

Ripplefold™ Stack Guide for Butt Master 84214xxx

Note: Stack size is estimated. Type of fabric used could alter these measurements. Please refer to the Ripplefold Fabrication Manual for more information.

120% Fullness	100% Fullness	80% Fullness	60% Fullness	Number of factory snaps	Snap Tape Length (less return length)*	Panel Stackback
149⅞	169⅞	188⅞	208⅞	80	338½	47¼
153⅞	173⅞	193⅞	213⅞	82	347	48¼
157⅞	177⅞	198⅞	218⅞	84	355½	49½
161⅞	182⅞	203⅞	224⅞	86	364	50½
164⅞	186⅞	207⅞	229⅞	88	372½	51½
168⅞	190⅞	212⅞	234⅞	90	381	52¾
172⅞	194⅞	217⅞	239⅞	92	389½	53¾
176⅞	199⅞	222⅞	245⅞	94	398	55
179⅞	203⅞	226⅞	250⅞	96	406½	56
183⅞	207⅞	231⅞	255⅞	98	415	57
187⅞	211⅞	236⅞	260⅞	100	423½	58¼
191⅞	216⅞	241⅞	266⅞	102	432	59¼
194⅞	220⅞	245⅞	271⅞	104	440½	60½
198⅞	224⅞	250⅞	276⅞	106	449	61½
202⅞	228⅞	255⅞	281⅞	108	457½	62½
206⅞	233⅞	260⅞	287⅞	110	466	63¾
209⅞	237⅞	264⅞	292⅞	112	474½	64¾
213⅞	241⅞	269⅞	297⅞	114	483	66
217⅞	245⅞	274⅞	302⅞	116	491½	67
221⅞	250⅞	279⅞	308⅞	118	500	68¼
224⅞	254⅞	283⅞	313⅞	120	508½	69¼
228⅞	258⅞	288⅞	318⅞	122	517	70¼
232⅞	262⅞	293⅞	323⅞	124	525½	71½
236⅞	267⅞	298⅞	329⅞	126	534	72½
239⅞	271⅞	302⅞	334⅞	128	542½	73¾
243⅞	275⅞	307⅞	339⅞	130	551	74¾
247⅞	279⅞	312⅞	344⅞	132	559½	75¾
251⅞	284⅞	317⅞	350⅞	134	568	77
254⅞	288⅞	321⅞	355⅞	136	576½	78
258⅞	292⅞	326⅞	360⅞	138	585	79¼
262⅞	296⅞	331⅞	365⅞	140	593½	80¼
266⅞	301⅞	336⅞	371⅞	142	602	81¼
269⅞	305⅞	340⅞	376⅞	144	610½	82½
273⅞	309⅞	345⅞	381⅞	146	619	83½
277⅞	313⅞	350⅞	386⅞	148	627½	84¾
281⅞	318⅞	355⅞	392⅞	150	636	85¾

Ripplefold™ Overlap Stack Guide

Note: Stack size is estimated. Type of fabric used could alter these measurements. Please refer to the Ripplefold Fabrication Manual for more information.

120% Fullness	100% Fullness	80% Fullness	60% Fullness	Number of factory snaps	Snap Tape Length (less return length)*	Panel Stackback
16¼	17¾	19⅞	20¾	8	34	9
20	22	23⅞	26	10	42½	10¼
23¾	26¼	28⅞	31¼	12	51	11¼
27½	20½	33⅞	26½	14	59½	12½
31¼	34¾	38⅞	41¾	16	68	13½
35	39	42⅞	47	18	76½	14½
38¾	43¼	47⅞	52¼	20	85	15¾
42½	47½	52⅞	57½	22	93½	16¾
46¼	51¾	57⅞	62¾	24	102	18
50	56	61⅞	68	26	110½	19
53¾	60¼	66⅞	73¼	28	119	20
57½	64½	71⅞	78½	30	127½	21¼
61¼	68¾	76⅞	83¾	32	136	22¼
65	73	80⅞	89	34	144½	23½
68¾	77¼	85⅞	94¼	36	153	24½
72½	81½	90⅞	99½	38	161½	25½
76¼	85¾	95⅞	104¾	40	170	26¾
80	90	99⅞	110	42	178½	27¾
83¾	94¼	104⅞	115¼	44	187	29
87½	98½	109⅞	120½	46	195½	30
91¼	102¾	114⅞	125¾	48	204	31
95	107	118⅞	131	50	212½	32¼
98¾	111¼	123⅞	136¼	52	221	33¼
102½	115½	128⅞	141½	54	229½	34½
106¼	119¾	133⅞	146¾	56	238	35½
110	124	137⅞	152	56	246½	36½
113¾	128¼	142⅞	157¼	60	255	37¾
117½	132½	147⅞	162½	62	263½	38¾
121¼	136¾	152⅞	167¾	64	272	40
125	141	156⅞	173	66	280½	41
128¾	145¼	161⅞	178¼	68	289	42
132½	149½	166⅞	183½	70	297½	43¼
136¼	153¾	171⅞	188¾	72	306	44¼
140	158	175⅞	194	74	314½	45½
143¾	162¼	180⅞	199¼	76	323	46½
147½	166½	185⅞	204½	78	331½	47½

Ripplefold™ Overlap Stack Guide

Note: Stack size is estimated. Type of fabric used could alter these measurements. Please refer to the Ripplefold Fabrication Manual for more information.

120% Fullness	100% Fullness	80% Fullness	60% Fullness	Number of factory snaps	Snap Tape Length (less return length)*	Panel Stackback
151¼	170¼	190½	209¾	80	340	48¾
155	175	194¾	215	82	348½	49¾
158¾	179¼	199½	220¼	84	357	51
162½	183½	204¾	225½	86	365½	52
166¼	187¾	209½	230¾	88	374	53
170	192	213¾	236	90	382½	54¼
173¾	196¼	218½	241¼	92	391	55¼
177½	200½	223¾	246½	94	399½	56½
181¼	204¾	228½	251¾	96	408	57½
185	209	232¾	257	98	416½	58½
188¾	213¼	237½	262¼	100	425	59¾
192½	217½	242¾	267½	102	433½	60¾
196¼	221¾	247½	272¾	104	442	62
200	226	251¾	278	106	450½	63
203¾	230¼	256½	283¼	108	459	64
207½	234½	261¾	288½	110	467½	65¼
211¼	238¾	266½	293¾	112	476	66¼
215	243	270¾	299	114	484½	67½
218¾	247¼	275½	304¼	116	493	68½
222½	251½	280¾	309½	118	501½	69½
226¼	255¾	285½	314¾	120	510	70¾
230	260	289¾	320	122	518½	71¾
233¾	264¼	294½	325¼	124	527	73
237½	268½	299¾	330½	126	535½	74
241¼	272¾	304½	335¾	128	544	75
245	277	308¾	341	130	552½	76¼
248¾	281¼	313½	346¼	132	561	77¼
252½	285½	318¾	351½	134	569½	78½
256¼	289¾	323½	356¾	136	578	79½
260	294	327¾	362	138	586½	80½
263¾	298¼	332½	367¼	140	595	81¾
267½	302½	337¾	372½	142	603½	82¾
271¼	306¾	342½	377¾	144	612	84
275	311	346¾	383	146	620½	85
278¾	315¼	351½	388¼	148	629	86
282½	319½	356¾	393½	150	637½	87¼

Pole Installation, Cutting & Splicing

Top Hole Installation Guide

This chart will position the bracket so the drapery will clear the floor approximately ½".

1. Find your pole style, size and header style in the chart.
2. Determine the desired finished drapery length.
3. Add or subtract number in the top hole column from the drapery's finished length to determine how high to measure for the top hole of the bracket.

Stationary Poles					
	Rod Pocket (no top ruffle)		Pleated (any variety)		
	Top Hole		Top Hole	Pin Set	
1 3/8" Standard Bracket	-1 13/16"		+1 9/16"	1/4"	
1 3/8" Decorative Bracket	-1 1/4"		+2 1/8"	1/4"	
2" Standard Bracket	-2 3/16"		+2 3/8"	1/4"	

Wall Mount Traverse Rods					
	Pleated (any variety)			Ripplefold™ (any fullness)	
	Top Hole for Wall Mount	Floor to Ceiling Deduction	Suggested Pin Set	Top Hole for Wall Mount	Floor to Ceiling Deduction
1 3/8" Estate™	+1 11/16"	-2 1/8"	1/2"	+1 11/16"	-2 1/8"
2" Estate™	+1 11/16"	-2 13/16"	1/2"	+1 11/16"	-2 13/16"

Ceiling Mount Traverse Rods					
1 3/8" Estate™	+0"	-3 5/8"	1/2"	+0"	-3 5/8"
2" Estate™	+0"	-3 5/8"	1/2"	+0"	-3 5/8"

Cutting & Splicing Wood Trends™ Poles

- Measure to desired length and carefully wrap area with an easy peel, blue painter's tape as not to damage the finish.
- Cut through the tape with sharp fine tooth saw. Cut slowly to reduce any chipping to the product finish.
- Drill a new finial pilot hole. Find rod center easily by drawing an X across the diameter of the pole using a 1/8" drill bit.
- Splice with pole connector. Always support the splice with a bracket.

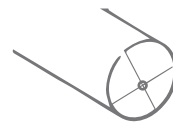

Find rod center by marking X across diameter of pole.



Pole Connector
#5610E061

Wood Elbow Configuration

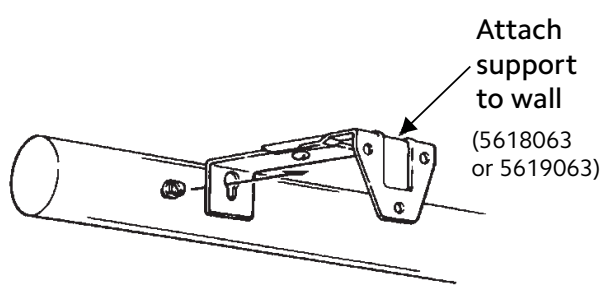
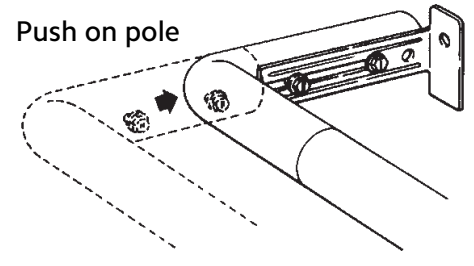
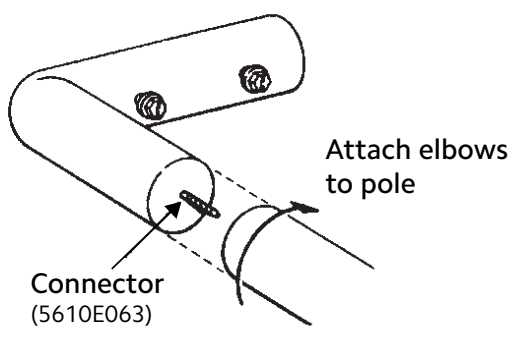
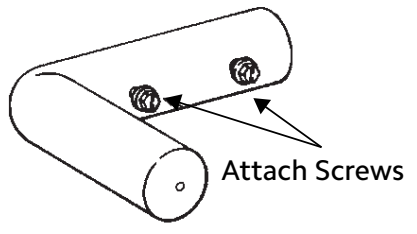
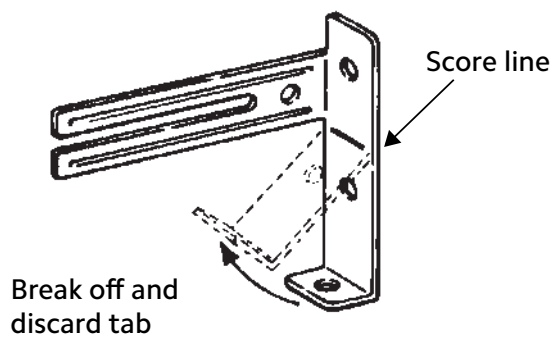

Learn more about all of our collections



	Designer Metals™ Collection	Wood Trends™ Collection	Wrought Iron Collection	Estate™ Traverse Rods Collection
	sophisticated styles acrylic and metals striking finishes	crafted timelessness beautiful finishes classic designs	architectural statement remarkable history real wrought iron	form meets function innovative solutions customizable
Available Diameters	1" 1 3/8" & 2"	1 3/8" & 2"	1" & 1 3/8"	1 3/8" Wrought Iron 1 3/8" & 2" Designer Metals™ Wood Trends™
Pole Lengths	Fixed - 4', 6' & 8' Telescoping - 36"-180"	4', 6', 8', 12'	6' & 8'	18"-16'
Pole Material	Metal	Wood	Metal	Wood & Metal
Operation Modes	Stationary, Traversing Manual or Motorized Draw	Stationary, Traversing Manual or Motorized Draw	Stationary, Traversing Manual or Motorized Draw	Traversing Manual or Motorized Draw
Pole Sizing	Fixed Width & Telescoping	Fixed Width	Fixed Width	Cut to Measure
Finishes	8	9	6	62
Finials	27	18	18	106
Bracket Types	Decorative Fixed & Bypass Fixed	Decorative Fixed	Decorative Fixed & Bypass Fixed	Concealed Adjustable
Bracket Sizes	3" - 8 3/4", Inside Mount & Ceiling Mount	3 1/2" - 7", Inside Mount & Ceiling Mount	3 1/2" - 6 1/2" & Inside Mount	1 3/4" - 3 1/4"
Treatment Styles	Stationary & Traversing	Stationary & Traversing	Stationary & Traversing	Traversing



Designer Metals | Stratta in Brushed Bronze



Wood Trends | Chaucer in Estate Oak, Black



Wrought Iron | Darby in Graphite, Heirloom Copper



Designer Metals™
inspiring brilliance

Wood Trends™
renewing traditions

Wrought Iron
forging artistry

**Custom Rodding
& Basic Hardware**
unique solutions